

MCC-I2.1 Specifications

MCC Design Group

Event Builder

Revision:	1.0
Reference:	ATLAS ID-xx
Created:	8 December 2003
Last modified:	1 September 2004 10:59
Edited By:	R. Beccherle and G. Darbo ATLAS/Pixel Collaboration

Abstract

This document describes the EventBuilder of the *MCC-I2.1*.

Table Of Contents

Abstract	ii
List of Figures	v
4 Event Builder.	1
4.1 Building blocks	1
4.1.1 EoE Encoder	1
4.1.1.1 Event Building Example.	2
4.1.2 Input Multiplexer	3
4.1.3 ScoreBoard	3
4.1.4 PendingLV1FIFO	3
4.1.5 Control State Machine	4
4.1.5.1 FeFlag Generator	4
4.1.5.2 State Machine	5
4.1.5.3 Event Formatting	6
4.1.6 Output Port	6
4.2 Test Features	8
4.2.1 MCC PlayBackMode	8
4.2.1.1 Event Building Test Example	8
4.2.2 MCC Internal Status Ckecks	9
4.3 Reset Actions	11
4.3.1 Response to a Pin Reset	11
4.3.2 Response to a GlobalResetMCC command	11
4.3.3 Response to a BCR command	11
4.3.4 Response to an ECR command.	11
4.4 SEU protection	12

List of Figures

Fig. 4-1 *p. 2* Logical scheme of the **EventBuilder** block.

4 Event Builder

This chapter will describe the `EventBuilder` block of the *MCC*.

Event building is performed by two concurrent processes running in the *MCC*. The first one deals with the filling of the 16 input FIFO's with data received from the corresponding *FE* chip and is performed by the `Receiver` (see Chapter 3, "Receiver") while the second one (`EventBuilder`) extracts data from the `ReceiverFifo`'s and builds up the event and is described in this chapter.

During normal conditions, each `Receiver` fills data hits from the *FE* chips into the `ReceiverFIFO`. When an `EoE` word is detected, the `Scoreboard` in the `EventBuilder` is updated for the corresponding `Receiver`. As soon as the `EventBuilder` finds at least one complete event, i.e. that all 16 *FE*'s have sent a complete event (the `Scoreboard` is used for that), it starts building up and transmitting the event. The first information written to the output data stream is the last word in the `PendingLv1Ffifo`. This FIFO is 16 bit wide and 16 word deep and stores the bunch crossing ID (`BCId`) and the `Lev1 ID (LEV1Id)`. The two ID's are the output bits of two counters: bunch crossing and `Trigger` counters. Only the 4 less significant bits of the `TriggerCounter` are written to the output data stream. The `BunchCrossingCounter` is updated once every clock cycle, while the `TriggerCounter` is incremented each time a `Trigger` is sent to the *FE* chips. The contents of the two counters are transferred to the `PendingLv1FIFO` each time a `Lev1` is transmitted to the *FE* chips from the *MCC*. At this point the `EventBuilder` starts fetching data from the first `ReceiverFifo` that contain data. Once data of this `Receiver` is completely read the `EventBuilder` switches to the next `Receiver` that contains data. After having transmitted data from all `ReceiverFifo`'s a `Trailer` word is written which ends the event data transmission. For more information on the output data format please refer to Chapter 5.4, "MCC to ROD Event Format".

The next section will describe in detail all building blocks that form the `EventBuilder`. In the second one we will describe the implemented test features, the third section will explain how the different types of reset signals action the `EventBuilder`, while the last one will describe how the `EventBuilder` is protected against the occurrence of `SEU` events.

4.1 Building blocks

Figure 4-1 shows the logical scheme of the `EventBuilder`. As can be seen from this figure there is a direct data path going from the `Receiver` blocks to the output of the *MCC*.

4.1.1 EoE Encoder

The `EoE` encoder is the block that selects which, out of the 16 input channels, is the active one. This block reads the information of which of the 16 *FE* chips are active from the `FEEN` register and provides the address of the next `ReceiverFIFO` that contains non null data. This is done with a priority encoder that enables one FIFO at a time. The first available data stream is selected based on the `FEEN` value and the presence of a `Hit` or a `WngEoE` word in the FIFO. If a `Hit` word is found it is copied to the output data stream, while if an `EoE` word containing flags (generated by the corresponding *FE* chip or by the `Receiver` itself) is found a `FEFlag` word is generated. The selection remains valid until the control state machines issues a `NextFE` signal, in which case the priority encoder will point to the next *FE* with data, if there is any.

 This is done only if the *MCC* is in `RunMode`. If we are reading one `ReceiverFifo` location with a `RdFifo` command the `EoE` encoder block simply provides the address that was specified in the `RdFifo` command.

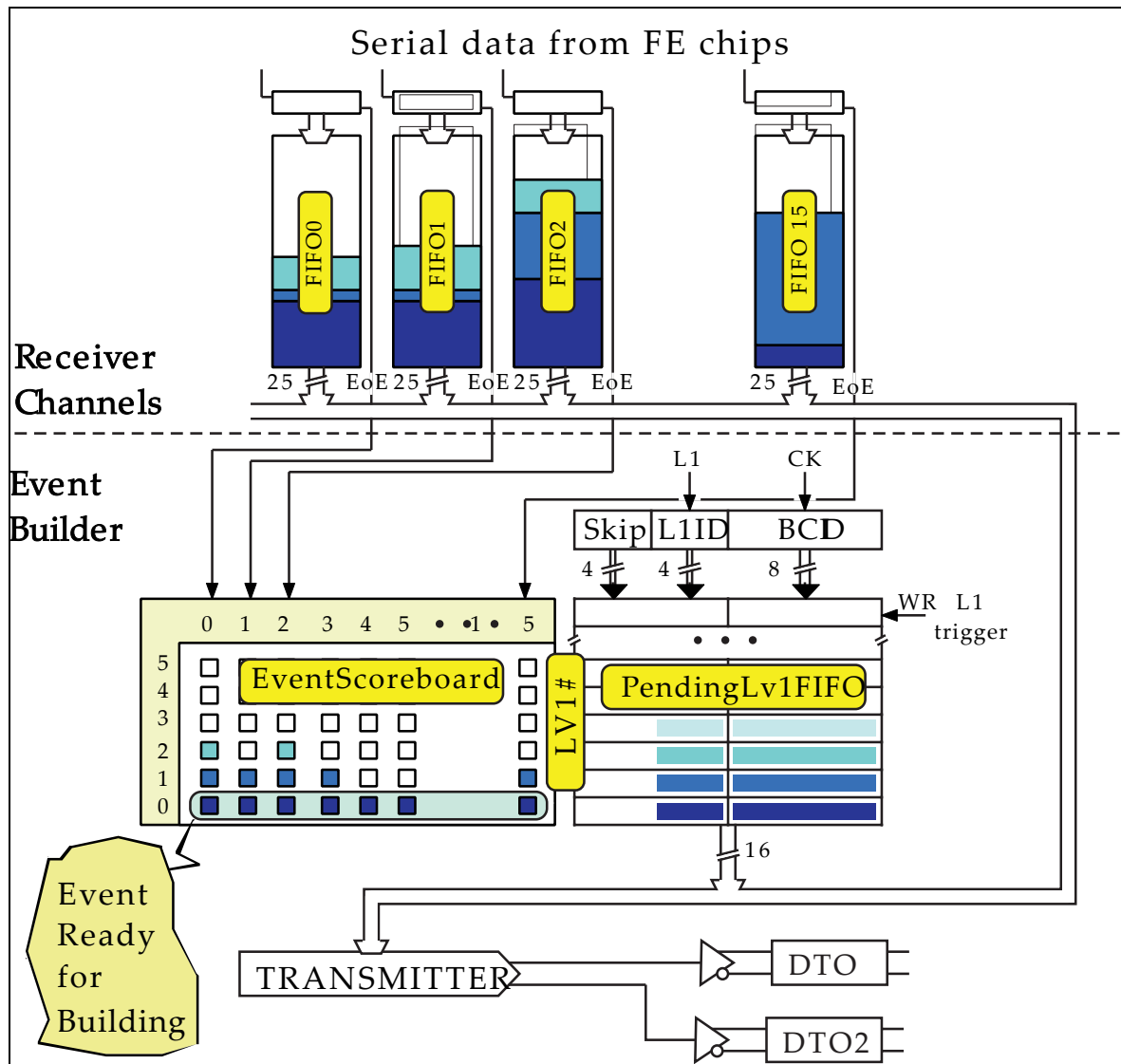

Figure 4-1 Logical scheme of the EventBuilder block.

This block also generates a signal that is active until there is data to be read out by any of the Receiver-FIFO (FEHaveData). This information is used by the EventBuilder control state machine.

4.1.1.1 Event Building Example

As an example lets suppose that all *FE*'s are enabled and that for that particular event FIFO # 1, FIFO # 7 contain valid data, FIFO # 2 contains a WngEoE word while all other ReceiverFifo's are empty (contain only the TrueEoE word). FEHaveData will be activated. After that, address "1" will be selected until all data is read out, then FIFO # 2 will be addressed in order to read the warning messages present in the EoE word, a FEFlag word will be generated due to the presence of this warning, than the priority encoder will provide address "7" until data completion and finally it will signal that there is no more valid data for that event disabling the FEHaveData signal which tells the control state machine that the event is finished. At this point, if the Receiver's do not contain anymore full events (one EoE word in each of the enabled ReceiverFifo's), the FEHaveData signal will be lowered until the ScoreBoard signals that a new complete Event has been detected.

4.1.2 Input Multiplexer

Based on the address information provided by the EoE encoder the multiplexer selects which data stream has to go to the control state machine for event building.

This block also multiplexes which of the 16 TrueEoE and WngEoE words coming from the 16 Register blocks has to be sent to the control state machine.

4.1.3 ScoreBoard

This block records the EoE information coming from all Receiver blocks that are enabled and generates a signal to be used by the control state machine for starting event building (**StartBuild**).

The ScoreBoard is formed by 16 independent 5 bit up-down counters that are incremented as soon as an EoE word (with or without warning flags) has been detected by a Receiver.

As soon as all the counter values are not zero (all Receiver blocks have seen at least one event) the signal is activated. This signal stays active until at least one of the counters is zero.

Immediately after having built a complete event the control state machine activates the DecrScore signal and all counters are decremented by one.

The counters cannot overflow as the MCC can not send more than 16 Trigger signals to the FE chips and inside each Receiver block there is a HitOverflow and an EoEOverflow check that ensure that there will never be more than 112 Hits and 16 EoE words per ReceiverFifo.

Also an underflow of the Scoreboard counters is not possible as the PendingLV1Fifo ensures that there will never be more than 16 Trigger commands sent to the Fe chips and the DecrScore signal is only issued after one MCC event has been reconstructed and this happens only after all 16 FE chips have sent their EoE word and this, in turn, can only happen after a FE chip has received a Trigger command.

4.1.4 PendingLV1FIFO

The PendingEventFIFO is 16 bit wide and 16 word deep fully synchronous, single-clocked FIFO.

The RdPtr is controlled by the EventBuilder control state machine while the WrPtr is controlled by the Trigger, Timing and Control block (TTC).

One word is written to the PendingEventFIFO each time a Trigger command is issued to the FE chips.

Each word of the PendingEventFIFO is 16 bit wide and is subdivided in three distinct fields.

PEF<15:12>: SkippedLV1 field. This 4 bit field contains the number of skipped LV1, as determined by the TTC. The maximum number can be 15 and means that 15 or more events have been skipped. There is a skipped LV1 each time a new Trigger command is received by the MCC, if there are still 16 Trigger commands sent to the FE chips without having started at least one EventBuilding process. This information is added by the EventBuilder control state machine to the output data stream in order to inform the ROD that a certain number of Trigger commands have been skipped.

PEF<11:8>: LV1ld field. This 4 bit field contains the 4 least significant bit of the LV1ld counter, an 8 bit up-down counter implemented in the TTC. This counter is incremented each time a Trigger command is detected by the MCC.

PEF<7:0>: BCID field. This 8 bit field contains the value of the BCID counter. This 8 bit counter is incremented at each clock cycle inside the TTC.

The PendingEventFIFO information is added immediately after the Header to all events formatted by the MCC (see Chapter 5.4, "MCC to ROD Event Format").

4.1.5 Control State Machine

This block is by far the most complex block of the EventBuilder as it has to deal with all event building control signals and to implement the complete event formatting according to the event grammar explained in Chapter 5.4, "MCC to ROD Event Format".

Each block that forms the Control State Machine is described in detail in the following sections.

4.1.5.1 FeFlag Generator

This block prepares the eventual FeFlag word to be added in the output data.

This block also performs an event consistency check between data belonging to the same event but to different FE chips. Each EoE word of a FE that has data, or just a WngEoE word, is checked. The LV1Id information of the first EoE word is stored in a 4 bit register and compared with EoE words belonging to other FE chips. As soon as a discrepancy is found the Lv1ChkFail signal for that particular FE is set. If there is only one FE with data no check is performed. In case the wrong LV1Id is in the first FE with data all subsequent FE will have the Lv1ChkFail bit set in their data stream. The same check is also performed for the BCId which is stored in each EoE word. In case of a discrepancy of this kind the BCIdChkFail signal is set.



If a FE chip does not have any data associated to an event no check is performed on both LV1Id and BCId fields of the EoE word.



Both consistency checks of the BCId and the LV1Id can be individually disabled by setting WBITD<11> and WBITD<12>. By default both checks are enabled.

During EventBuilding as soon as a BCIdChkFail or a Lv1ChkFail signal is found a FeFlag word is added to the MCC output data stream. This FeFlag word will contain the information of which of these checks has caused the error.

The FeFlag word is an 16 bit word subdivided in two logically distinct parts:

FeFlag<7:0>: This 8 bit contain the warning messages generated by the FE chips. As explained in Chapter 3.1.3, "Control State Machine", these messages are added by the FE chips to their EoE word and are stored by the Receiver inside the FIFO in the EoE word. The EventBuilder simply copies this information in this field. See the FE chip specification document for the full description of the single bits. The presence of such a flag is written to the corresponding bit of WFE register.

FeFlag<15:8>: This 8 bit contain the warning messages generated by the MCC. As explained in Chapter 3.1.3, "Control State Machine" three bits are generated in the Receiver block. The consistency checks between hits belonging to different FE chips, but to the same event, instead are performed inside the FeFlag generator block. The three remaining bits are not implemented in this version of the MCC but space is allocated for eventual extensions in future versions of the chip.

The meaning of the single bits of FeFlag<15:8> is the following:

- FeFlag<15:13>:** These three bits are always “000” in this version of the *MCC*.
- FeFlag<12>:** There has been a *Lv1ChkFail* in the event. This means that there is data inconsistency inside the current event due to a different *LV1Id* number between the current *FE* and the first *FE* with data.
This information is also written to CSR <12>.
- FeFlag<11>:** There has been a *BCIdChkFail* in the event. This means that there is data inconsistency inside the current event due to a different *BCId* number between the current *FE* and the first *FE* with data.
This information is also written to CSR <11>.
- FeFlag<10>:** There has been a *Lv1ChkFail* in the corresponding Receiver. This means that there is data inconsistency between the *Hits* belonging to that particular *FE*.
This information is also written to the corresponding bit of the *WMCC* register.
- FeFlag<9>:** There has been an *EoEOverflow*. This happens if, for a particular Receiver, there are already 16 *EoE* words written to the *ReceiverFIFO* and another *EoE* word is sent by the *FE*. In this case the exceeding *EoE* word is dropped and the flag is set. This information is also written to the corresponding bit of the *WMCC* register.
-  This should never happen as the *MCC* ensures, by construction, that there are never more than 16 *Trigger* commands sent to the *FE* chips. This is a strong indication that some data corruption happened in the *FE* chip (for example a *SEU* turned a *Hit* into an *EoE* word).
- FeFlag<8>:** There has been a *HitOverflow*. This happens if, for a particular Receiver, the maximum number of *Hits* (112) has been reached and that *FE* keeps sending data. In this case all additional *Hits* are dropped and this bit is set.
This information is also written to the corresponding bit of the *WMCC* register.

 There is no *FeFlag* generation in case of skipped *LV1*'s. In such a case the number of skipped triggers is simply added to the *LV1* field of the last event without skipped events.

4.1.5.2 State Machine

This state machine is responsible for the event grammar decoding and generates a control signal for the event formatting block (*DoutSelect*). This is a 3 bit signal that by default is cleared. A new signal is generated, during event building, only after the *OutputPort* has sent a *DataRequest* signal. This signal is issued only once the *OutputPort* has “almost finished” sending out data.

The state machine knows when to start event building listening the *FEHaveData* signal issued by the *EoEEncoder* block.

 If the *MCC* is not in *RunMode* the only possible values states of the machine are the idle state and the one that produces data in response to a *RdFifo* command.

The state machine also generates all control signals needed during event building by the whole *MCC*. This signals are:

- NextFE:** Signal used by the *EoEEncoder* to select the next *FE* with available data.
- DecrScore:** Signal used by the *ScoreBoard* to decrement all its counters.
- RdPendingEventFifo:** Signal used by the *ScoreBoard* to read the next location of the *PendingLV1Fifo*.

4.1.5.3 Event Formatting

This block formats the event word according to **DoutSelect** signal generated by the state machine. This word is put in a 26 bit wide register that contains the data (**DataOut**). In addition it generates a 26 bit mask registers that tells the **OutputPort** which of the 26 bits are significative (**DataMask**) and a 5 bit word (**DataSize**) that tells the **OutputPort** how many bits of the word are used.

DoutSelect can have 7 different values with the following meaning:

- DoutSelect = 0:** This is the default case and means that there are no data to be sent out. In this case **DataOut**, **DataMask** and **DataSize** are all zero.
- DoutSelect = 1:** In this case **Sync**, "0111" and **FeNumber** are written to **DataOut** and **DataSize** is 9.
- DoutSelect = 2:** In this case **Sync**, **Row#**, **Col#** and **ToT** information are written to **DataOut** and **DataSize** is 22.
- DoutSelect = 3:** In this case **Sync**, "1_1111" and **FeFlag** are written to **DataOut** and **DataSize** is 22.
- DoutSelect = 4:** In this case **Sync** and **Trailer** information are written to **DataOut** and **DataSize** is 23.
- DoutSelect = 5:** In this case nothing is written to **DataOut** and **DataSize** is 24. This case is used when a certain number of **Trigger** commands were skipped (not sent to the *FE* chips) in order to allow the *ROD* to pad the data stream with the missing events.
- DoutSelect = 6:** In this case the **Header** and **ReceiverFIFO** data are written to **DataOut** and **DataSize** is 26.
- DoutSelect = 7:** In this case the **Header**, **SkippedLv1**, **LV1Id**, **Sync** and **BCID** are written to **DataOut** and **DataSize** is 22.

 Setting accordingly registers **WBITD**, **WRECD** and the **RECD** bit of the **CSR** register, as explained in Section 2.1.1.2, "RECD: Receiver disable", one can selectively block flag generation (also just for some Receivers) in the *MCC* output data stream. This allows for some bandwidth reduction in case of a known problem in one of the components of the module.

4.1.6 Output Port

This block deals with data formatting of the *MCC* depending on the selected output mode **OM** (see Chapter 2.1.1.1, "OM<1:0> : Output Mode select"). All data transmitted by the *MCC* on the *MCC-DTO* pins which involves data coming from the **ReceiverFIFO**'s is generated by this block.

The **OutputPort** will fetch data from the control state machine 26 bit wide **DataOut** register. All bits that are not masked by **DataMask** will be copied to a 32 bit wide register (**DataStore**). This register is organized as a one-dimensional FIFO with read and write pointers. Data will be copied starting from the first free location of this register. At the same time the **DataSize** value will be added to an up-down counter that controls the pointers to **DataStore**. Depending on the selected **OM** the counter is then decremented by 1, 2 or 4 each clock cycle. As soon as the counter is below a fixed threshold new data will be copied to the **DataStore** register. This is done sending the **DataRequest** message to the **EventBuilder** state machine and a **RdReceiverFifo** to the correct **Receiver**. When the **DataStore** register is empty "0" will always be written to the output.

This mechanism allows to asynchronously write data to the **DataStore** as soon as enough space becomes available and read data from **DataStore** at different speeds depending on the selected **OM**.

The output of this block is a 4 bit wide register that holds the information to be written on both MCC-DTO pins. Data are written to this register according to the selected output mode.

- OM = 0:** Same data on both links at 40 Mb/s with 40 Mb/s bandwidth. In this case four copies of the same information are written to the register.
- OM = 1:** Data on both links at 40 Mb/s with 80 Mb/s bandwidth. In this case two bits of data are written at each clock cycle to the output register. The first bit of information is written to register location “0” and “2” while locations “1” and “3” will hold the second bit of data.
- OM = 2:** Same data on both links at 80 Mb/s with 80 Mb/s bandwidth. In this case two bits of data are written at each clock cycle to the output register. The first bit of information is written to register location “0” and “1” while locations “2” and “3” will hold the second bit of data.
- OM = 3:** Data on both links at 80 Mb/s with 160 Mb/s bandwidth. In this case four bits of data are written at each clock cycle.

The ModulePort will sample this data and distribute it correctly on both links. This module will always sample location “0” of this register on the rising edge of the clock and transmit it on MCC-DTO 0, location “1” on the rising edge of the clock and transmit it on MCC-DTO 1, location “2” on the falling edge of the clock and transmit it on MCC-DTO 0 and location “3” will be sampled on the falling edge of the clock and transmitted on MCC-DTO 2 (see Section 5.5, "MCC to ROD Physical Layer Protocol").



If we have to process a RdFifo command the OM is automatically switched to “0”, in order to ensure that data in response to configuration commands is always written at 40 Mbit/s on both links.



Data will always be formatted in such a way to ensure that the first bit of the Header word is always on the rising edge of MCC-DTO 0.

4.2 Test Features

In the *MCC* there are many different test features implemented in order to maximize the debugging capability both of the *MCC* itself and a whole module with all *FE* chips connected. This is particularly useful during module production tests in order to decouple the *MCC* behaviour from the rest of the module, and during the experiment where one has no more physical access to the module.

This test modes should allow the final user to perform any significant check that is needed to understand if the chip is still working and to eventually be able to understand which part of the chip is not working properly, even once the *MCC*'s have been installed inside the detector.

In the next two sections we will describe the two main *MCC* test modes.

4.2.1 MCC PlayBackMode

In order to be able to completely test the *EventBuilder* a special operating mode was built in the system. This mode is called *PlayBackMode* and is enabled by setting *PLBK* register in the CSR <6>.

After the *MCC* is in *PlayBackMode* one can write data to the *ReceiverFIFO*'s using the *WrReceiver* command. This command (see Section 1.2.3.7, "*WrReceiver*: Write data into a Receiver") allows to write data to any *ReceiverFIFO*, using the *FEEN* register, as if data would be coming from the *FE* chips. This allows the *EventBuilder*'s *ScoreBoard* and *PendingEventFifo* to be set up correctly in order to start event building. Once one has written all data to the *FIFO*'s one can put the *MCC* in *RunMode* with the *EnableDataTake* command and start sending *Trigger* commands as if in real *RunMode*. At this point the whole *EventBuilder* works as if with real data and allows a complete check of it's functionality. One can check all possible conditions, *FeFlag* generation capability, *Hit* or *EoE* overflows, etc. writing data that has some errors in it.

 During *PlayBackMode* all *MCC-DTI* lines (the lines that transmit data from the *FE* chips to the *Receivers*), are still connected and therefore one has to make sure that all enabled *FE* chips do not send data. This should be ensured by the fact that no *Trigger* commands are sent to the *FE* chips.

This is a very useful operation mode in order to be able to test the system prior to connecting the *FE* chips or in a real system if there are problems in order to understand if they are related to the *MCC* itself or to one or more *FE* chips.

 As usual if one issues a *Slow* command the chip is taken out of *RunMode* but the *PLBK* bit is not cleared and therefore one has to clear it writing the correct word to the *CSR* register.

4.2.1.1 Event Building Test Example

Suppose we would like to test the *EventBuilder* with all 16 *FE* chips enabled and with a *FeFlag* due to a wrong *LV1Id* present in *FE # 3*. Suppose also that only *FE # 1* and *FE # 14* have both just one *Hit*. The *OM* to be selected is data on both links at 40 Mb/s with 80 Mb/s bandwidth.

In this case we would have to issue the following commands:

1. *GlobalResetMCC*: Resets the *MCC*.
2. *WrRegister CSR 0x0041*: Sets the desired output speed (0001) and sets the *PLBK* bit (0040).
3. *RdRegister CSR*: Checks that we wrote the correct value. This command returns the header followed by 0x0041 on both *DTO-0* and *DTO-1* lines.
4. *WrRegister FEEN 0x0001*: Enables *FE # 1*.

5. RdRegister FEEN: Checks that we wrote the correct value. This command returns the header followed by 0x0001 on both DTO-0 and DTO-1 lines.
6. WrRegister CNT 0x0007: Writes the length of the data stream to be used by the WrReceiver command. In this case commands with up to 56 bits will be accepted.
7. RdRegister CNT: Checks that we wrote the correct value. This command returns the header followed by 0x0007 on both DTO-0 and DTO-1 lines.
8. WrReceiver 0000 HitData EoEData: Writes the Hit and the EoE words to FE # 1 (note the dummy but required field 0000).
9. WrRegister FEEN 0x8000: Enables FE # 14.
10. RdRegister FEEN: Checks that we wrote the correct value. This command returns the header followed by 0x8000 on both DTO-0 and DTO-1 lines.
11. WrReceiver 0000 HitData EoEData: Writes the Hit and the EoE words to FE # 14 (note the dummy but required field).
12. WrRegister FEEN 0x0004: Enables FE # 3.
13. RdRegister FEEN: Checks that we wrote the correct value. This command returns the header followed by 0x0004 on both DTO-0 and DTO-1 lines.
14. WrReceiver 0000 EoEData: Writes the EoE words with the wrong LV1Id to FE # 3 (note that one does not have to change the value of CNT in order to write less bits).
15. WrRegister FEEN 0x7ffa: Enables all remaining FE chips.
16. RdRegister FEEN: Checks that we wrote the correct value. This command returns the header followed by 0x7ffa on both DTO-0 and DTO-1 lines.
17. WrReceiver 0000 EoEData: Writes the EoE words to all remaining FE chips (note that one single command is needed as all EoE words are the same).
18. EnDataTake: Sets the MCC in RunMode.
19. Trigger: Starts the EventBuilder and writes the event at 80 Mbit/s on both DTO lines.

4.2.2 MCC Internal Status Ckecks

In addition to the ability to perform an EventBuilding Test one has the ability to readout all relevant internal structures that contribute to the EventBuilding process.

One can for example completely disable the EventBuilder Control State Machine setting EVBDIS register in the CSR <7>. If this mode is enabled the EventBuilder Control State Machine is always in it's idle state and therefore does not start the Eventbuilding process.

 In order to use this test mode one is advised (even if it is not mandatory) to set the PLBK register in the CSR <6> in order to disable Trigger sending to all FE chips, and thus avoiding that FE chips produce independent input to the MCC.

At this point one can easily populate the ReceiverFifo's using the WrReceiver command as in the EventBuilding Test Example explained before. The contents of all ReceiverFifo's can be checked using the RdFifo command (ensuring that one reads each FIFO an integer multiple of 128 times in order to leave the ReceiverFifo pointer positions unaffected).

An additional option at this point is the ability to check the contents of the **ScoreBoard** status using the **RdRegister 1000** (SBSR address). This operation can be performed as many times one desires in order to monitor that the **ScoreBoard** populates correctly.

At the end one may send a congruous sequence of **Trigger** commands (still staying in **PlayBackMode**) in order to completely read out the data which has been stored in the **ReceiverFifo**'s.

Of course, one can also monitor the status of the **PendingLV1Fifo** during this process remembering to set the **MCC** in **RunMode** after each **Slow** command and making sure all pointers of the **PendingLV1Fifo** do not change their actual locations (issue an integer multiple of 16 **RdRegister 0111** commands).

4.3 Reset Actions

This section will describe the response of the `EventBuilder` on all available reset commands that can be used in the `MCC`.

The only block that is not affected by any reset signal is the input multiplexer as it contains only combinational logic. For all the others block the reset is synchronous, as throughout the whole chip, and therefore one needs to have the clock active in order to perform a reset of this block.

4.3.1 Response to a Pin Reset

The pin reset (`MCC-RS1b`) has the same functionality as the `GlobalResetMCC` command. Even the pin reset is a synchronous reset and therefore one has to ensure that the clock signal is applied in order to be able to reset the chip in this way.

4.3.2 Response to a `GlobalResetMCC` command

In case of a `GlobalResetMCC` command the whole `EventBuilder` gets cleared.

All the counters are reset to '0', the pointers of the `PendingEventFifo` are re initialized and after a `GlobalResetMCC` command point both to location '0', the `ScoreBoard` is cleared and the `EventBuilder` state machine is put to it's idle state. All data transmission in the `OutputPort` is stopped and eventual flags are cleared. All test modes are cleared.

4.3.3 Response to a `BCR` command

The `BCR` command has no effect on the `EventBuilder`.

4.3.4 Response to an `ECR` command

An `ECR` command clears all structures in the `EventBuilder`. This means that for the `EventBuilder` this command is completely equivalent to a `GlobalResetMCC` command.

This allows for a fast reset of the `DataPath` of the `MCC` without exiting `RunMode`, as prescribed by the `ECR` command.

4.4 SEU protection

In order to protect the Event Builder against the occurrence of SEU we decided to triplicate as much control logic as possible. Triplicating the entire EventBuilder was not feasible because of its size.

The Input Multiplexer contains only combinational logic and has therefore no need to be protected.

The OutputPort and EoEEncoder blocks only contain data in the eventbuilding data path (data that is not stored inside the MCC for longer period of time) and are therefore less critical even if they could cause errors during the EventBuilding process in case of a SEU. An error in one of this blocks would cause an MCC Event format error but cannot block the chip or even the EventBuilding process.

The Control State Machine is by far the most critical part of the whole Eventbuilder and it was decided to fully triplicate it adding a majority voting circuit to all of its outputs in order to always take the correct output. Also this state machine is designed in order to return to its idle state as soon as eventBuilding has completed or an error is detected. Therefore the risk of upsetting two different state machines before their return to idle condition is minimized even if not completely absent.

 The ScoreBoard block is the only block that could cause problems, as it stores important information for correct event readout and synchronization but, due to its size, it was decided not to triplicate it. An upset in one of the counters that form the ScoreBoard would cause alignment problems but this would induce the MCC to generate many FE-Flag words in its output data stream and therefore one can solve the problem issuing an ECR command.