

# Tracking Performace of a CMOS Monolithic Active Pixel Sensor

J.D. Berst, G.Claus, C.Colledani, W.Dulinski, Y.Hu, D.Husson, J.P.Le Normand, J.L. Riester, R.Turchetta  
LEPSI, IN2P3/ULP, 23 rue du Loess, BP20, F-67037 Strasbourg, France

G.Deptuch<sup>1</sup>, U.Goerlach, G.Orazi, M.Winter  
IReS, IN2P3/ULP, 23 rue du Loess, BP20, F-67037 Strasbourg, France  
<sup>1</sup>visitor from UMM, Cracow, Poland

## Contents

- Idea and basic architecture of a CMOS MAPS
  - Prototype MIMOSA chip
- Charge collection : simulation and measurements
  - High energy particles beam test results :  
**S/N, efficiency, spatial resolution**
- Conclusion and Future Development Prospects

## Basic CMOS Camera single cell electronics and readout electronics

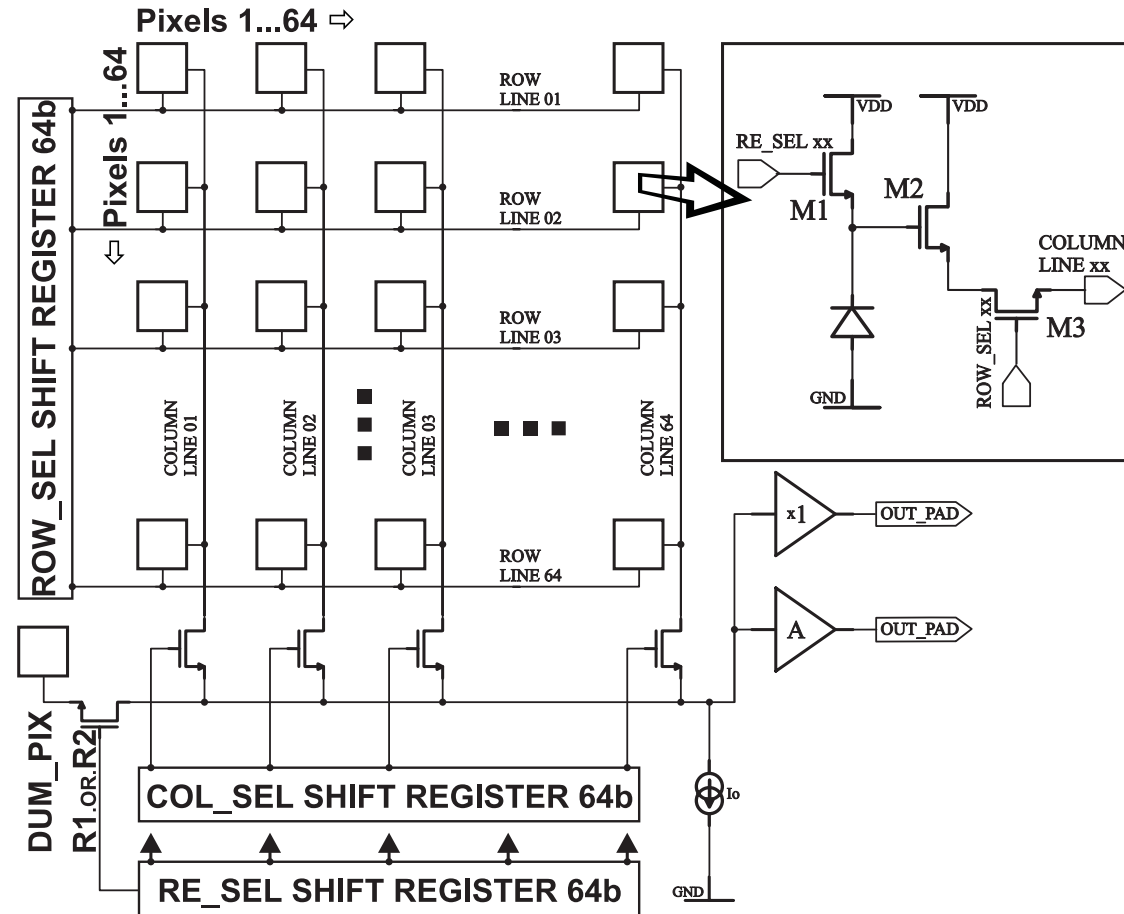

## Cross-section of a wafer with a charge collecting structure allowing 100% Fill Factor

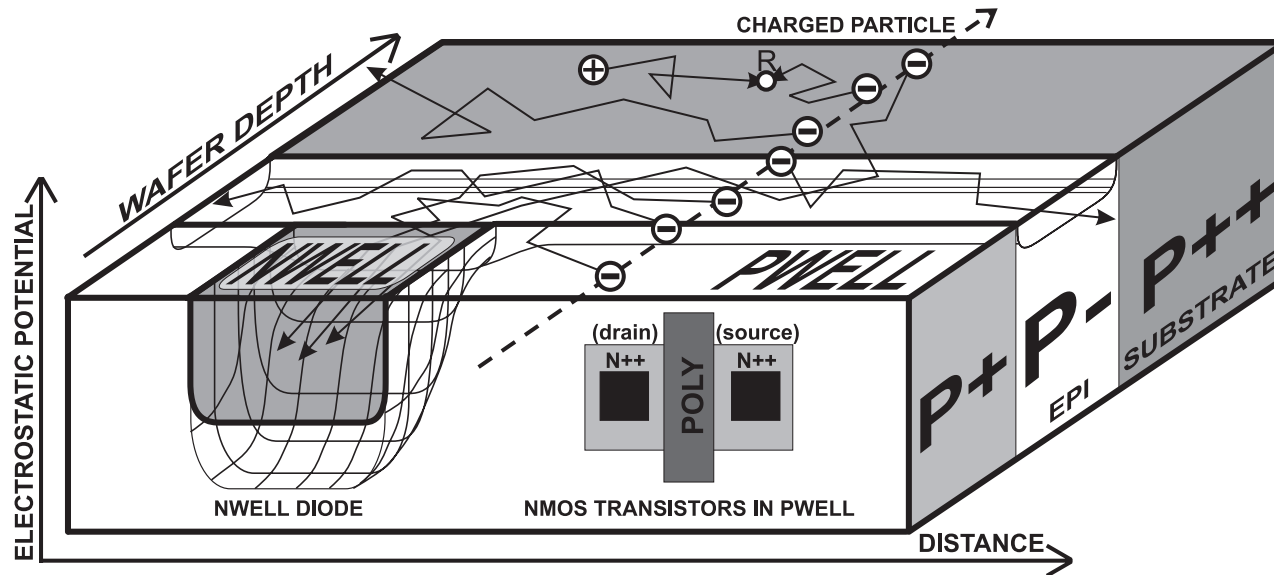

## Prototype MIMOSA chip

- standard 0.6  $\mu\text{m}$  CMOS technology
- 15  $\mu\text{m}$  thick EPI layer
- 4 matrices of 64x64 pixels each
- 20  $\mu\text{m}$  pitch in both direction

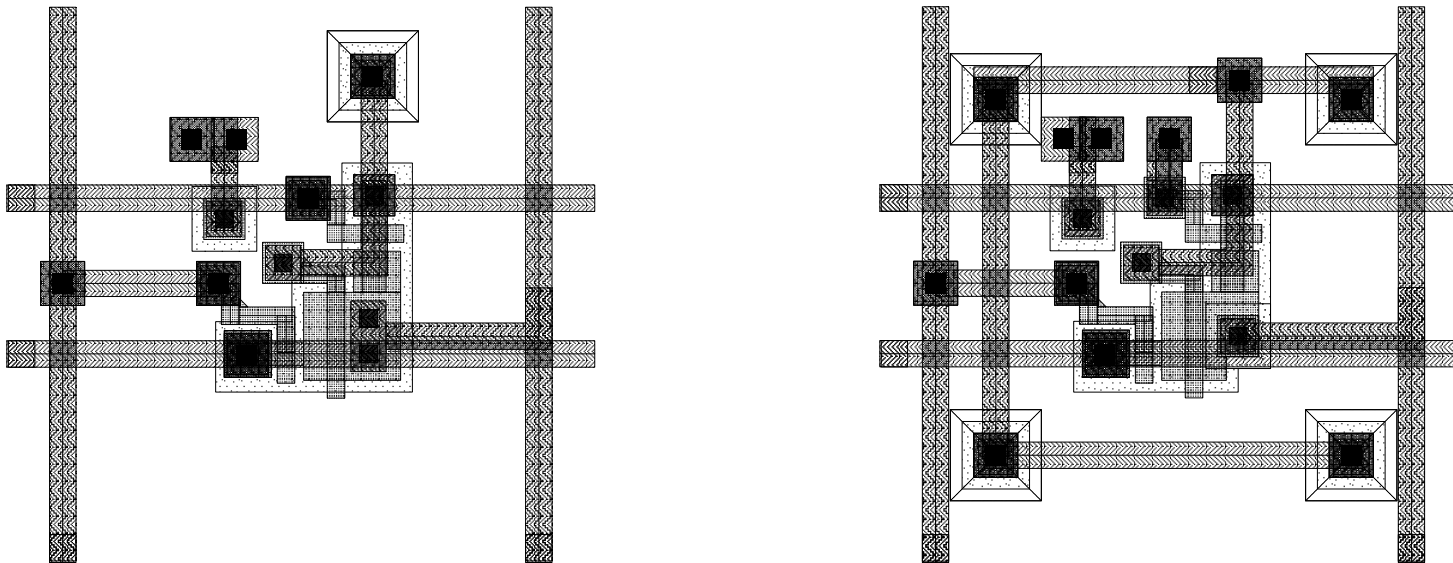

## Readout method of a prototype MIMOSA chip

Readout frequency : 2.5 MHz

FADC 12 bits

Buffer : 8192 words/channel

1 channel = 1 MIMOSA matrix

### Correlated Double Sampling (CDS)

Goal : suppression of both kTC Noise  
and Fixed Pattern (Noise)

Use of a circular buffer:

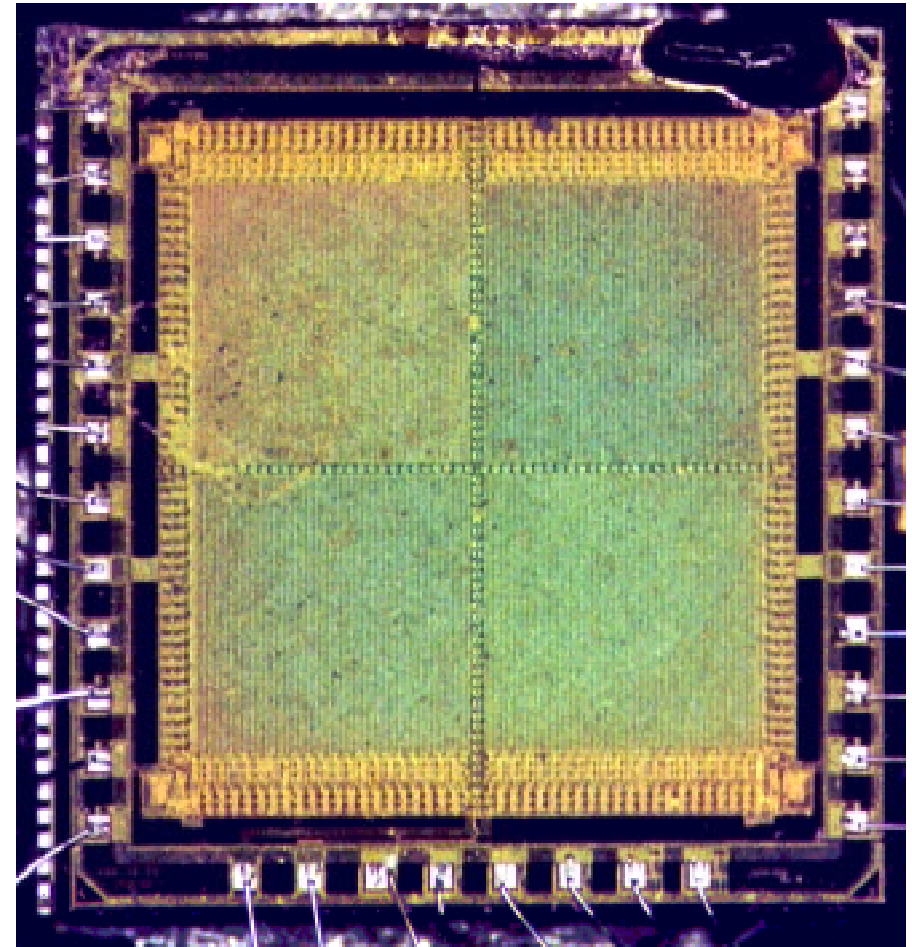

Charge collection performance using TOSCA (el. field) + Monte Carlo (transport)

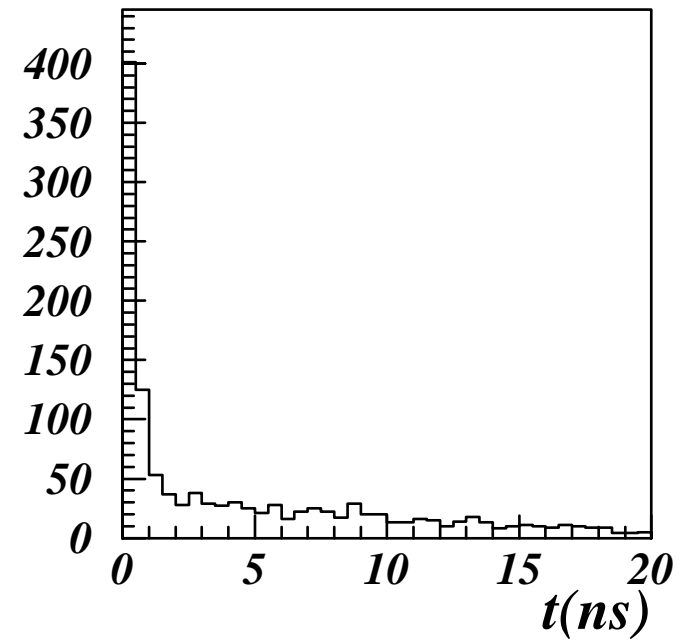
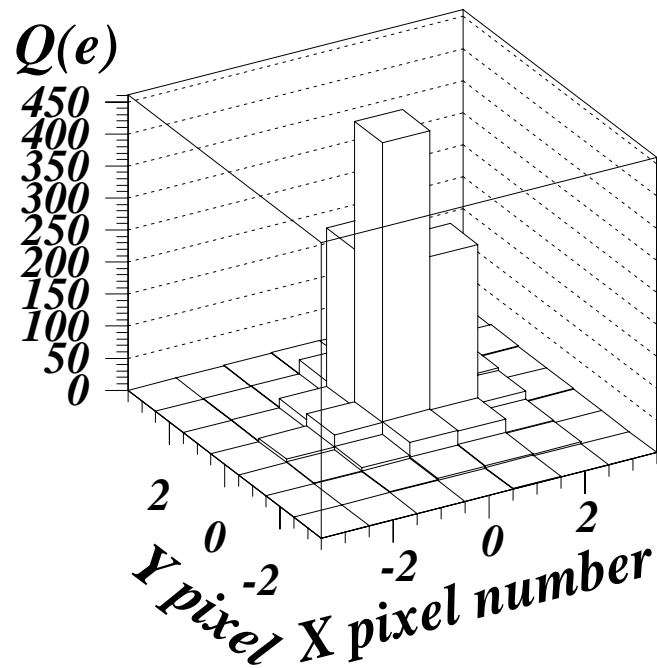

## Device simulation using ISE-TCAD software package

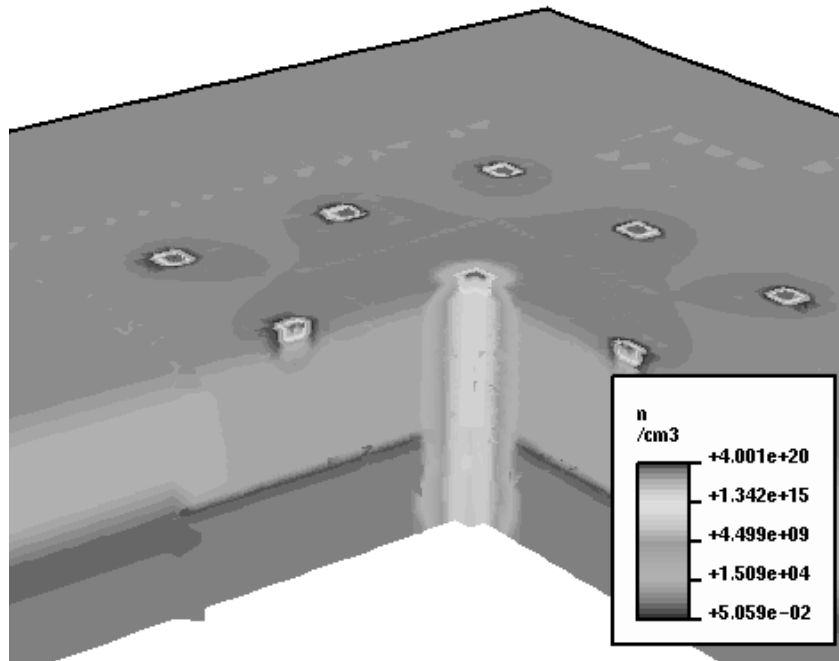

$\tau = 0$  ns

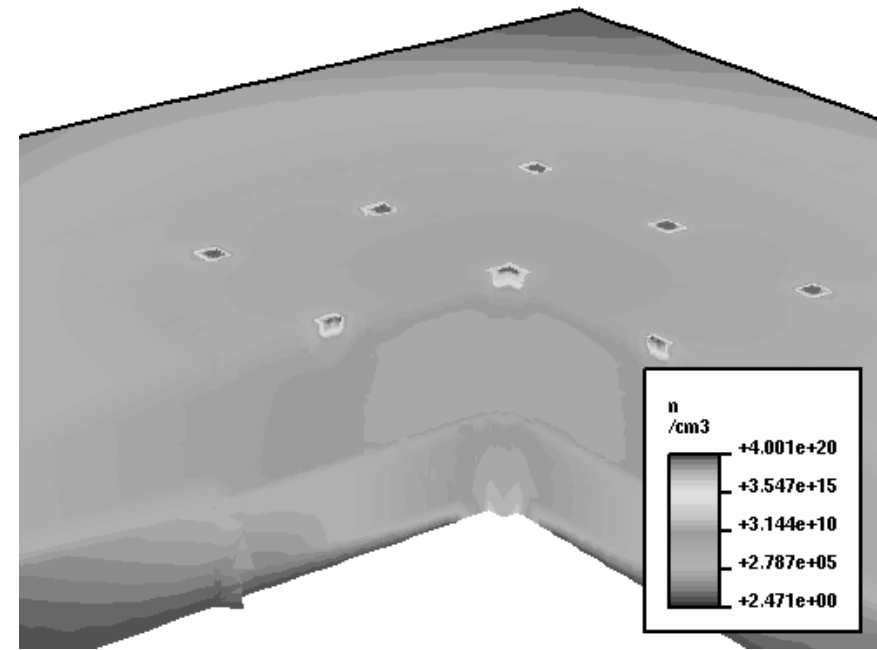

$\tau = 25$  ns

Carrier concentration

## Device simulation using ISE-TCAD : charge collection versus time as a function of a hit position

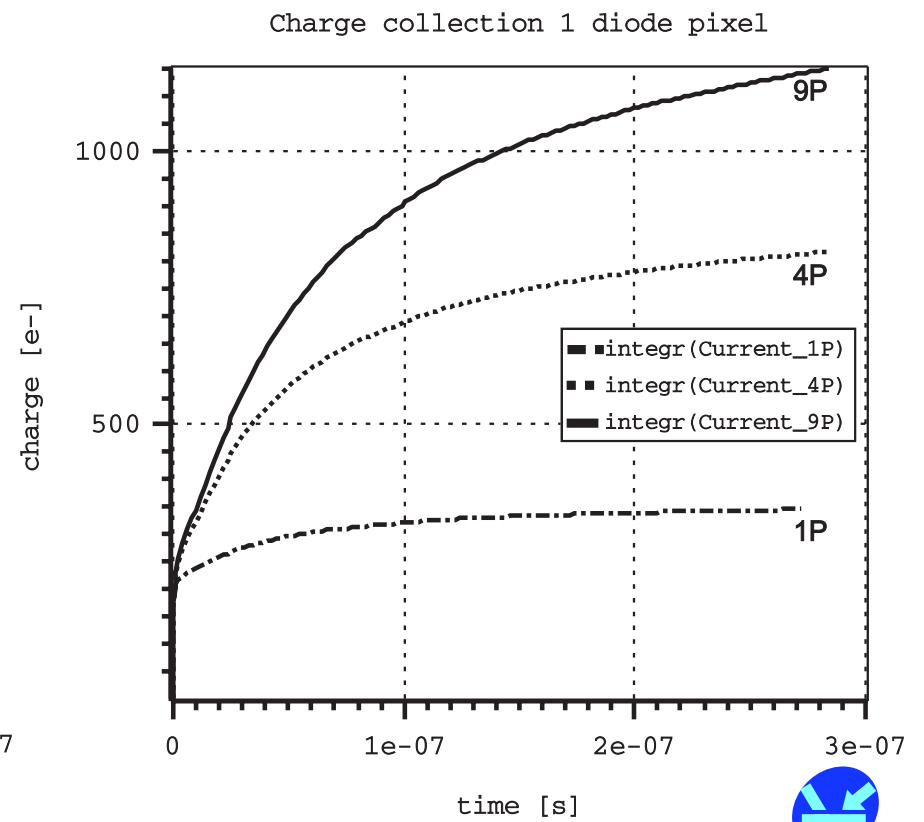
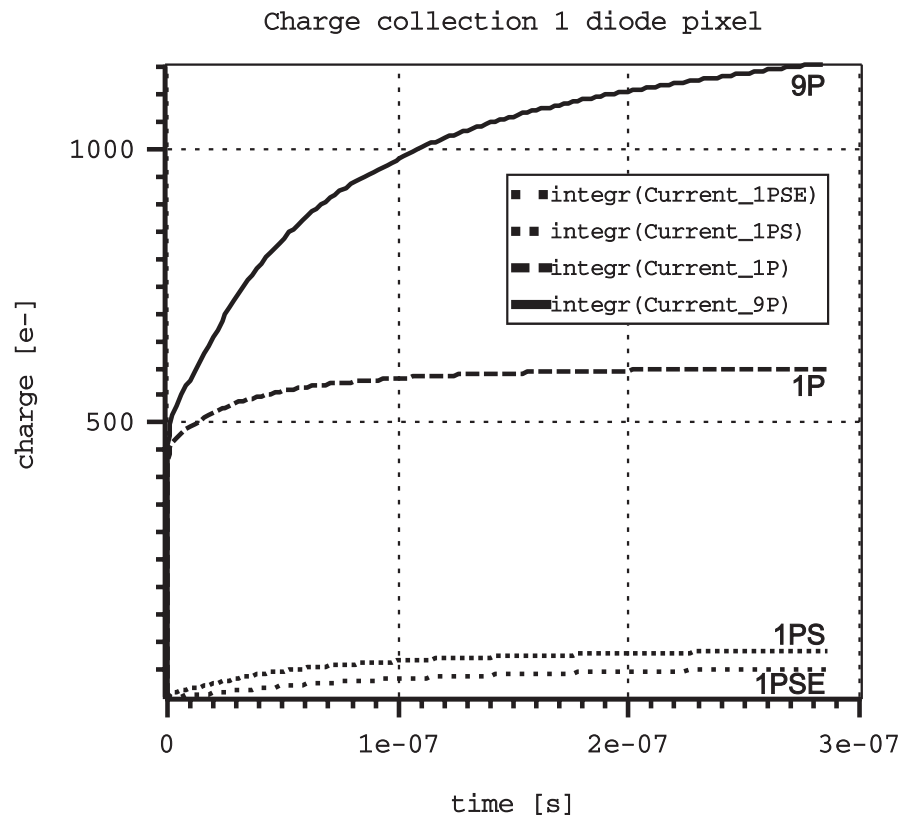
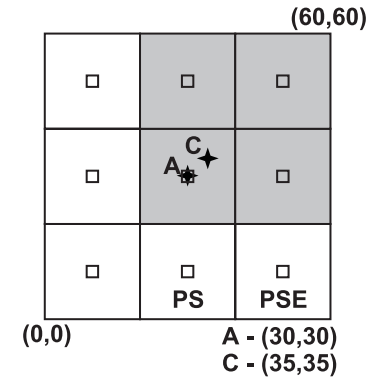



## Tests using visible and IR laser pulse ( $\Delta t < 10\text{ns}$ )

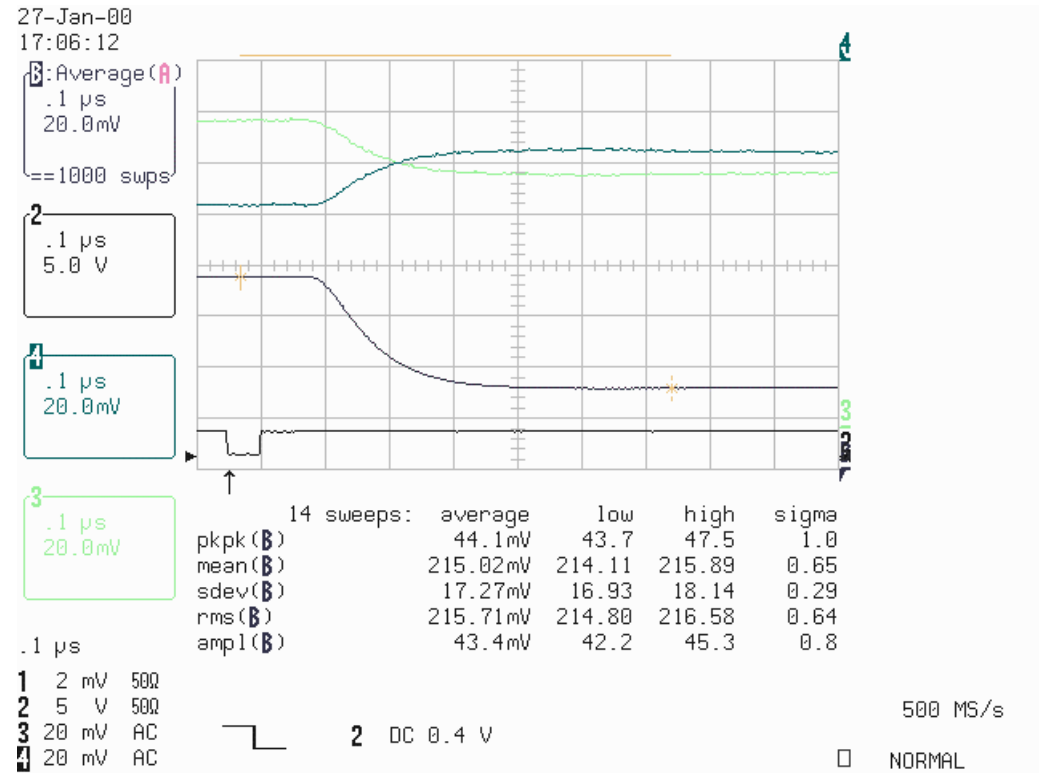
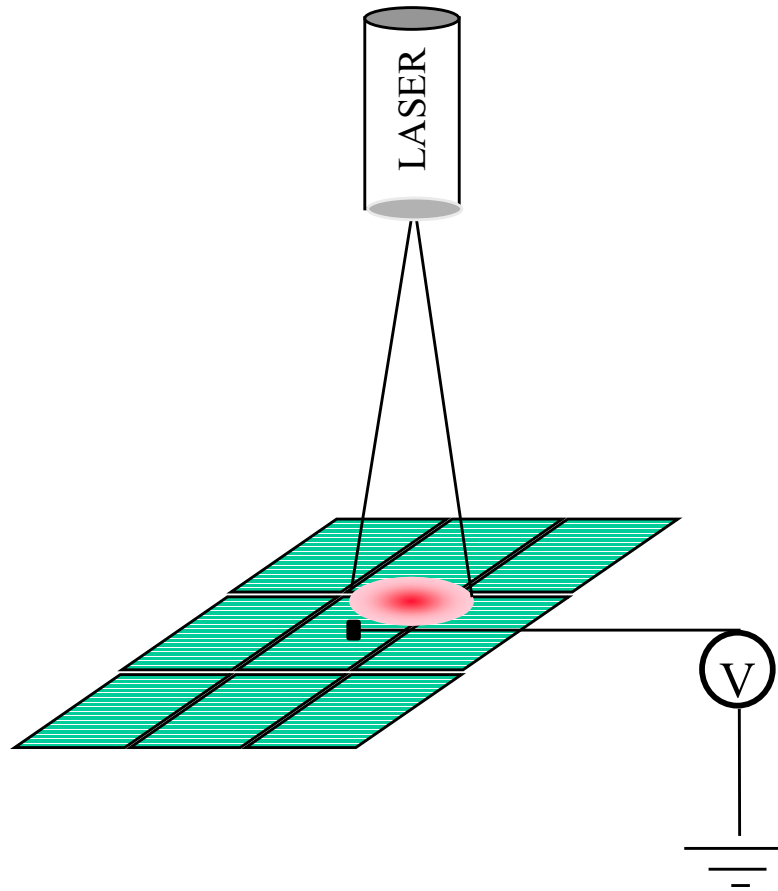

# MIMOSA I

## Charge-to-Voltage Conversion Gain - soft X-ray approach

- X-rays photons ( $^{55}\text{Fe}$ ) - 5.9 keV
- 1640 e-h
- peak position -  $\epsilon \cdot 1640 \text{ e}^-$

### 1-diode pixels

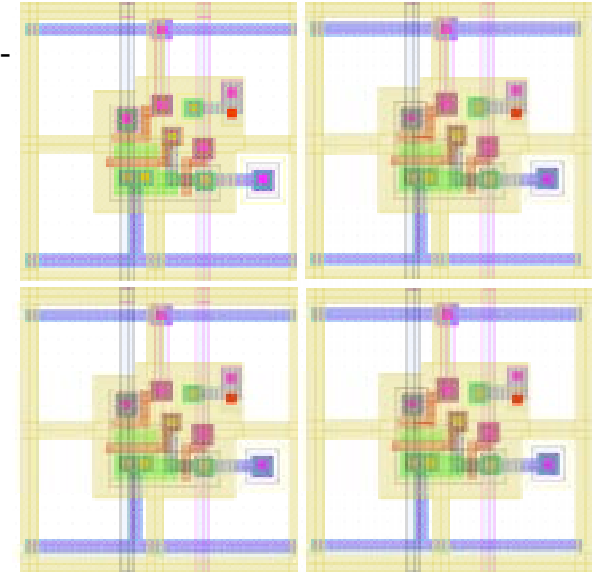

### 1P

#### Central pixel

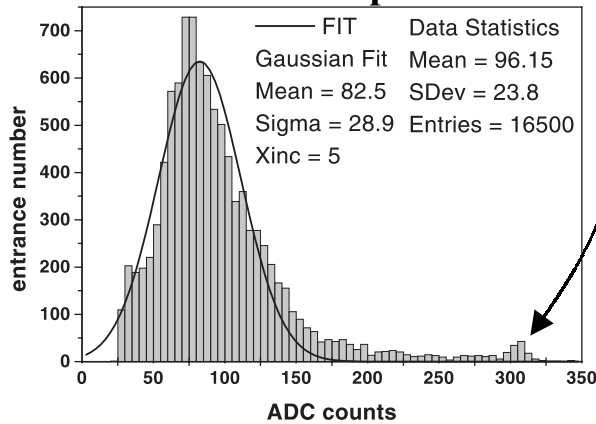

#### Second peak zoom in

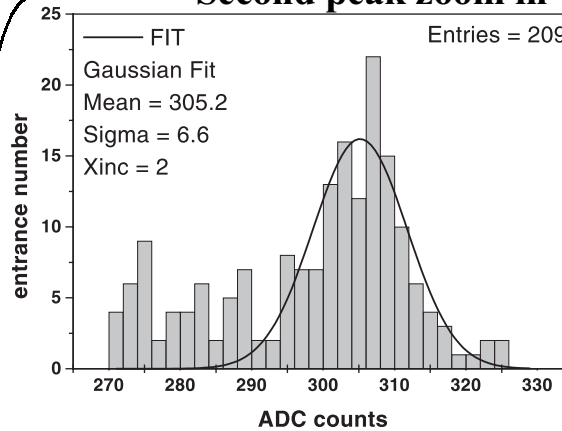

#### Cluster of 4 pixels

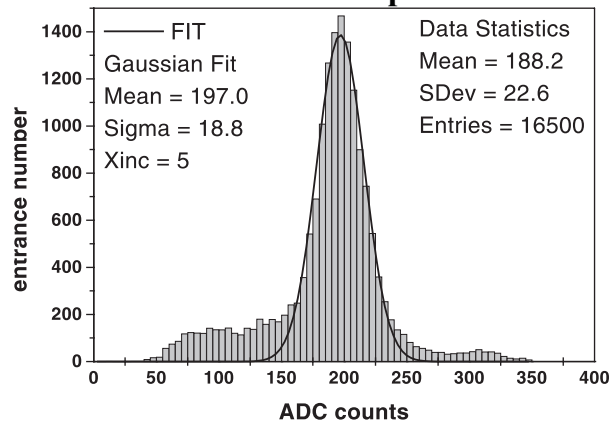

#### Cluster of 9 pixels

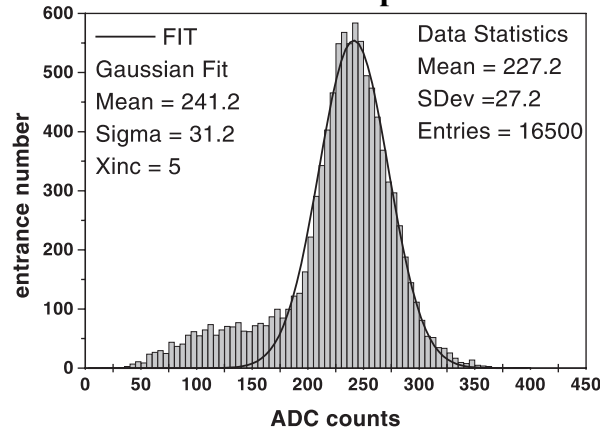

#### Cluster of 25 pixels

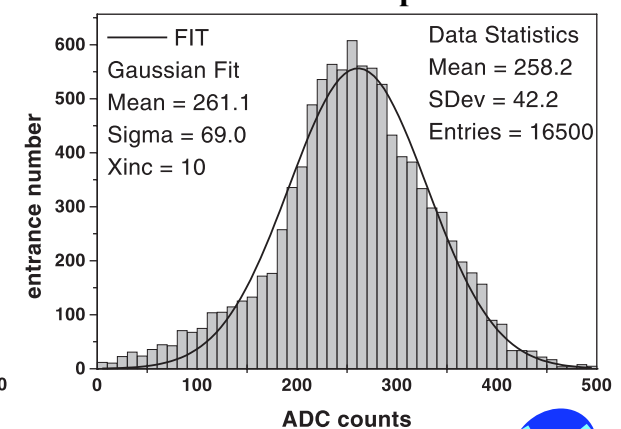

# MIMOSA I

## Charge-to-Voltage Conversion Gain - soft X-ray approach

- X-rays photons ( $^{55}\text{Fe}$ ) - 5.9 keV
- 1640 e-h
- peak position -  $\epsilon \cdot 1640 \text{ e}^-$

## 4-diode pixels

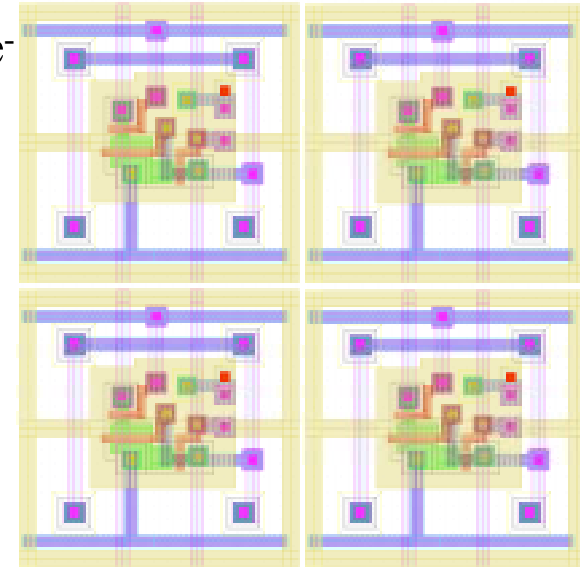

4P

Central pixel

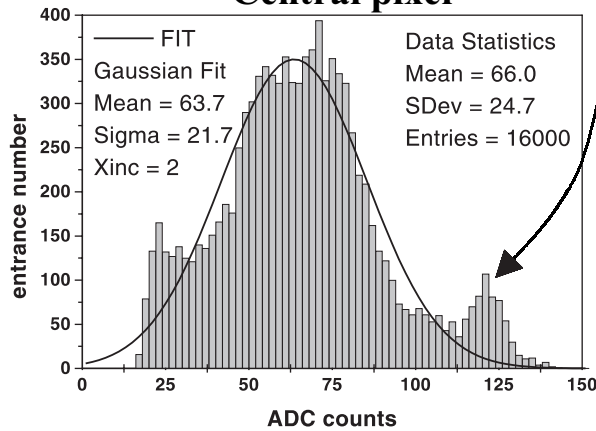

Second peak zoom in

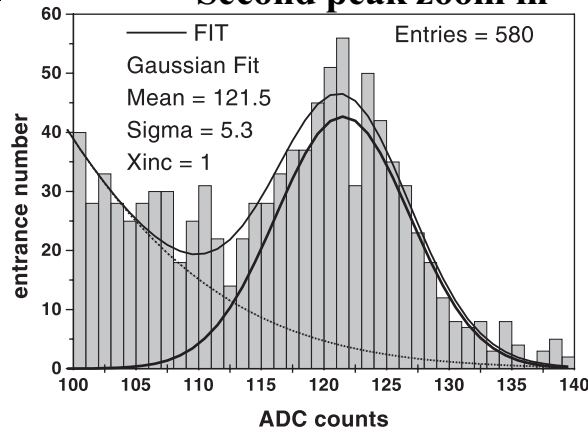

Cluster of 4 pixels

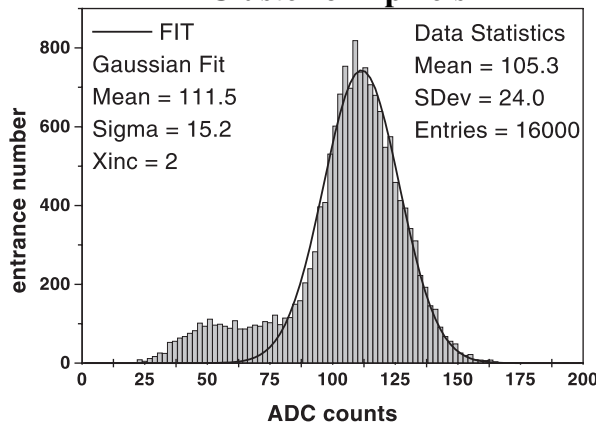

Cluster of 9 pixels

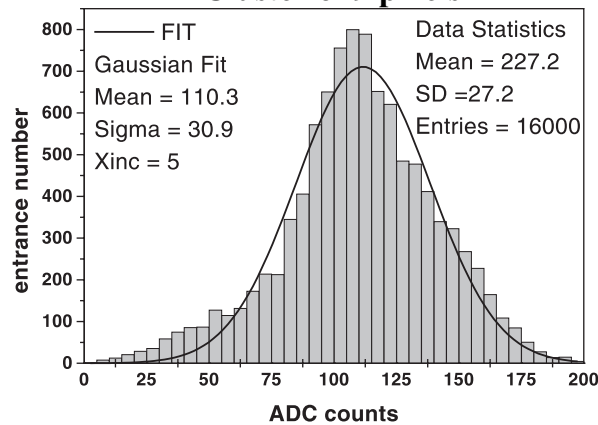

Cluster of 25 pixels

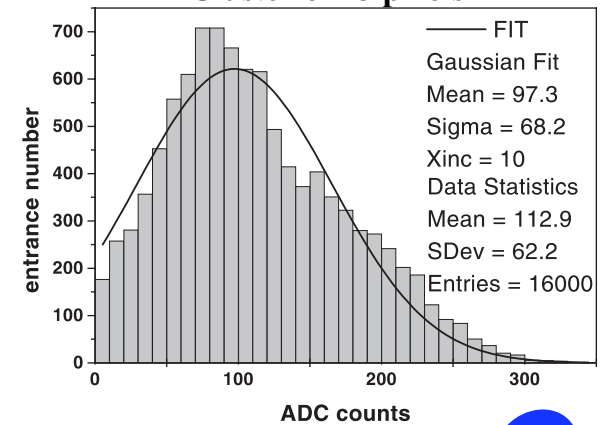

# MIMOSA I

## Charge-to-Voltage Conversion Gain - soft X-ray approach

- **charge distribution - cluster size !!!**

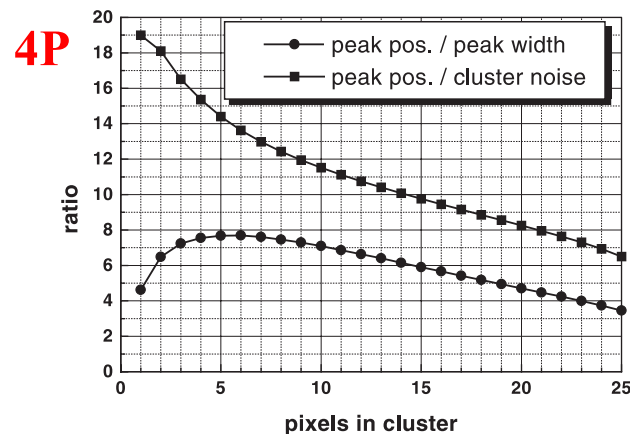
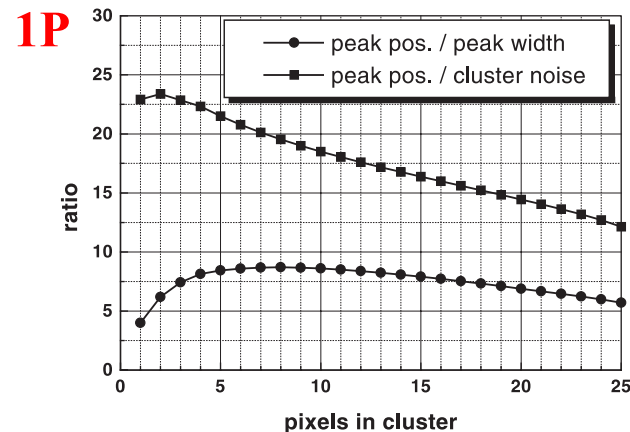

- **According to MC simulation the “big peak” doesn’t correspond with 100% of charge collection efficiency !!!**

- **Taking second peak position (conversion in a depletion region of the collecting diode)...**

$$A_{\text{int}} \cdot A_{\text{ext}} = 11.40 \text{ ADC/mV} \pm 0.15 \text{ ADC/mV}$$

**1P:**  $\frac{1640 e^-}{305.2 \text{ ADC}} \approx 5.37 e^- / \text{ADC} \Rightarrow \bar{g} = 16.30 \pm 0.25 \mu\text{V} / e^-$   
noise : 23 e<sup>-</sup>/pixel (CDS)

**4P:**  $\frac{1640 e^-}{121.5 \text{ ADC}} \approx 13.50 e^- / \text{ADC} \Rightarrow \bar{g} = 6.5 \pm 0.1 \mu\text{V} / e^-$   
noise : 47 e<sup>-</sup>/pixel (CDS)

Cluster size	1 pixel	2x2 pixels	3x3 pixels	5x5 pixels
Total charge : single-diode [e <sup>-</sup> ]	443	1058	1295	1402
Total charge : 4-diode [e <sup>-</sup> ]	1130	1505	1506	1524

- **hit position distribution in a detector array**

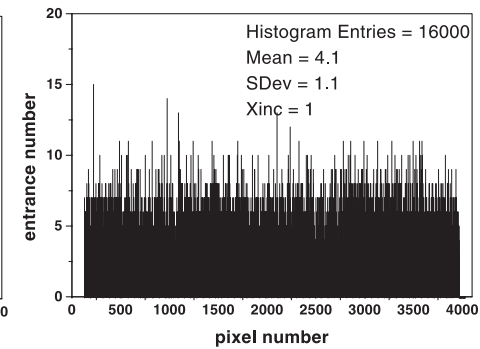
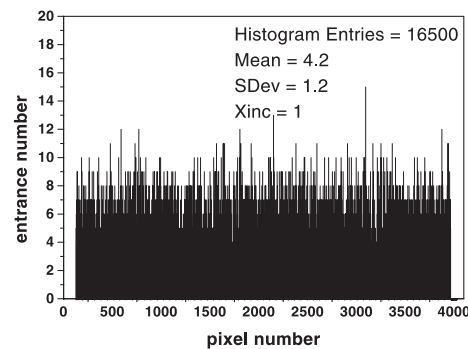

## Charge-to-Voltage Conversion Gain Measurements using steady excitation (visible light) and statistical method

Variance of measured signal:

$$\sigma^2 = \sigma_l^2 + \sigma_p^2 + \sigma_e^2$$

Due to the Poisson statistics of a photoelectron signal :

$$\sigma^2 = G A_{\text{int}} A_{\text{ext}} V_s + \sigma_e^2$$

where G is a charge-to-voltage conversion gain

array	$\bar{g}$ [ $\mu\text{V}/e^-$ ]	FPN $\bar{g}$	$\sigma_e$ [ $e^-$ ]*	FPN $\sigma_e$
1P	15.8±0.5	0.8±0.2	30±1	6
4P	6.7±0.2	0.7±0.3	63±2	13

\* Noise given for the signal frame after CDS

### Experimental results

## Particle tracking tests using 15 GeV/c pions and high precision beam telescope

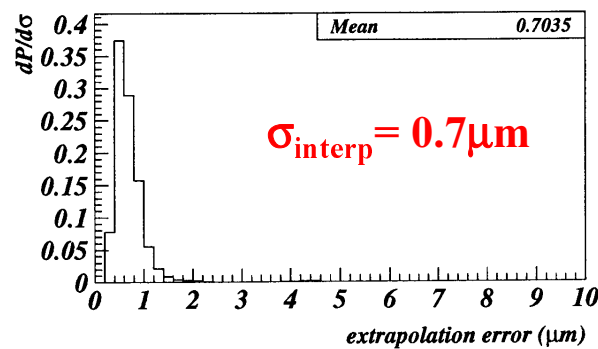
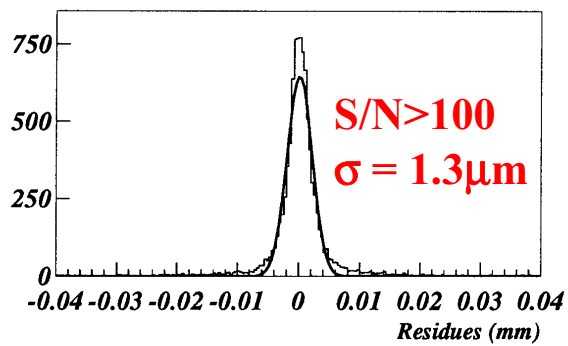
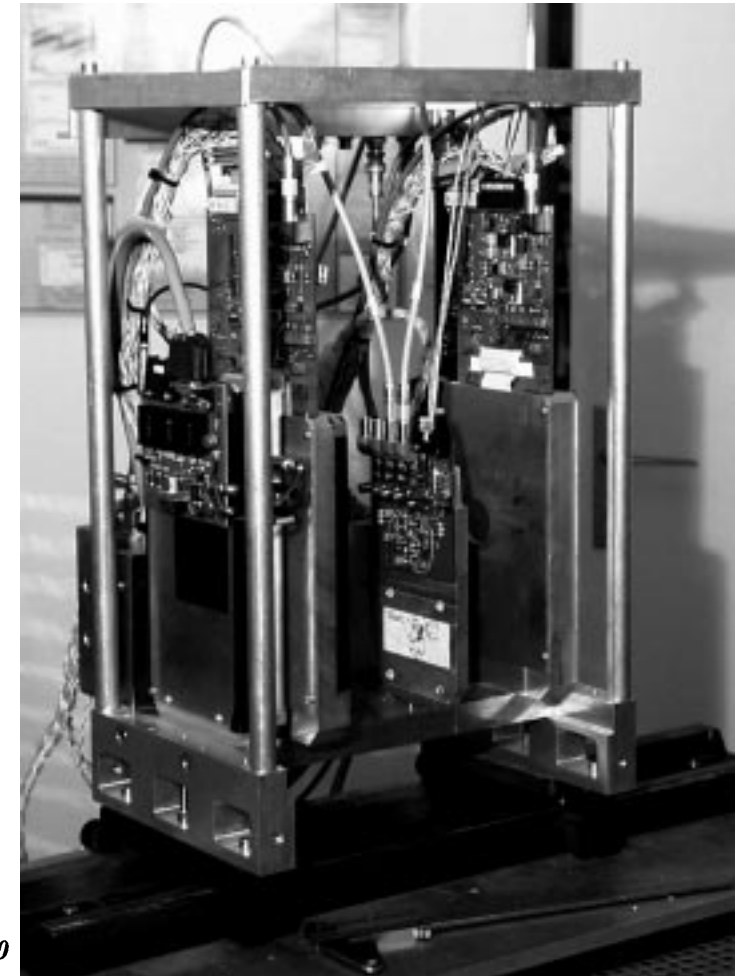
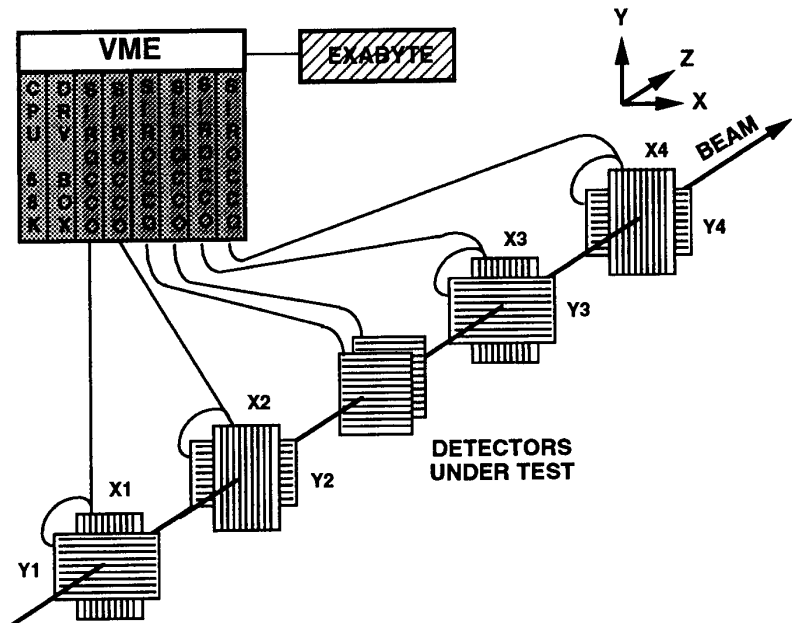

Single plane resolution

Track position resolution  
in the middle of telescope

## Tracking tests : on-line monitor display

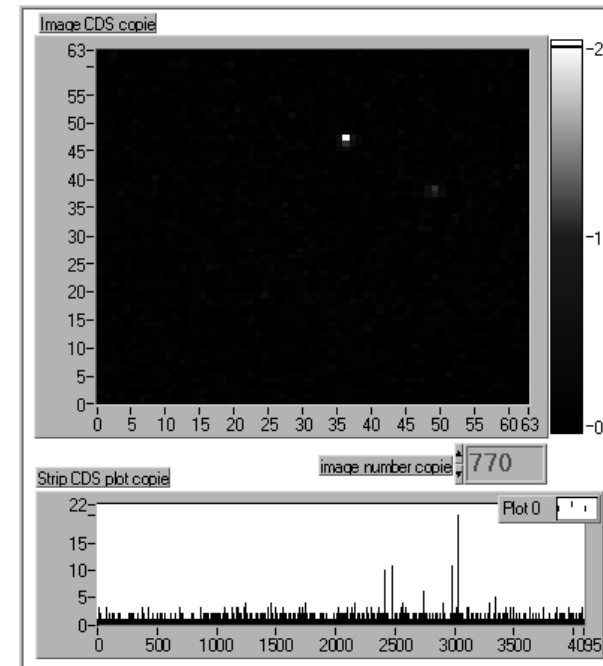
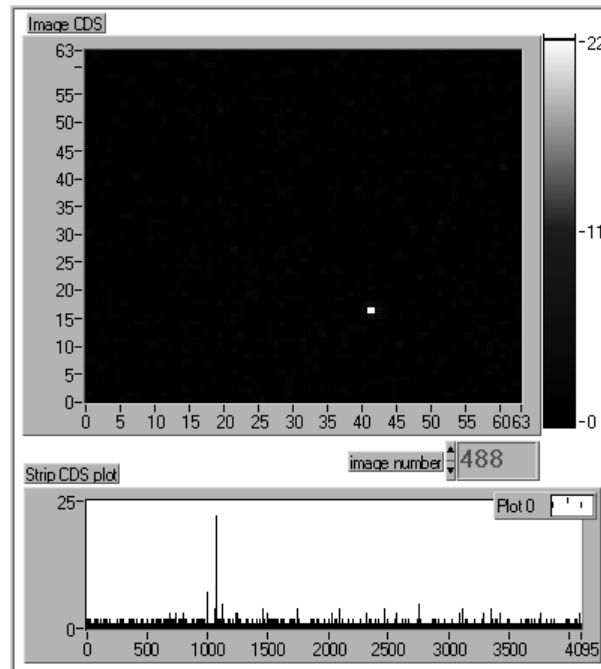

## Tracking tests : charge collection

Cluster charge with 9 pixels

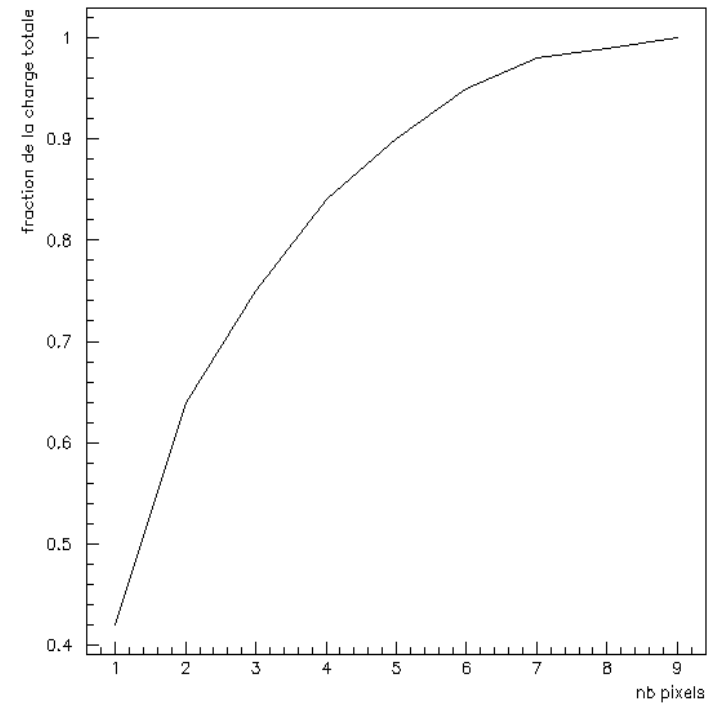
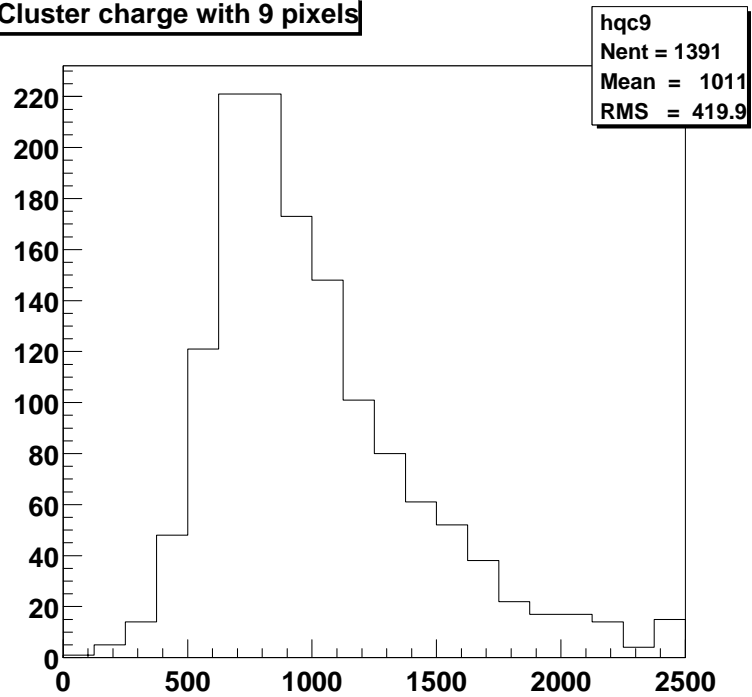



## Tracking tests : S/N versus cluster size

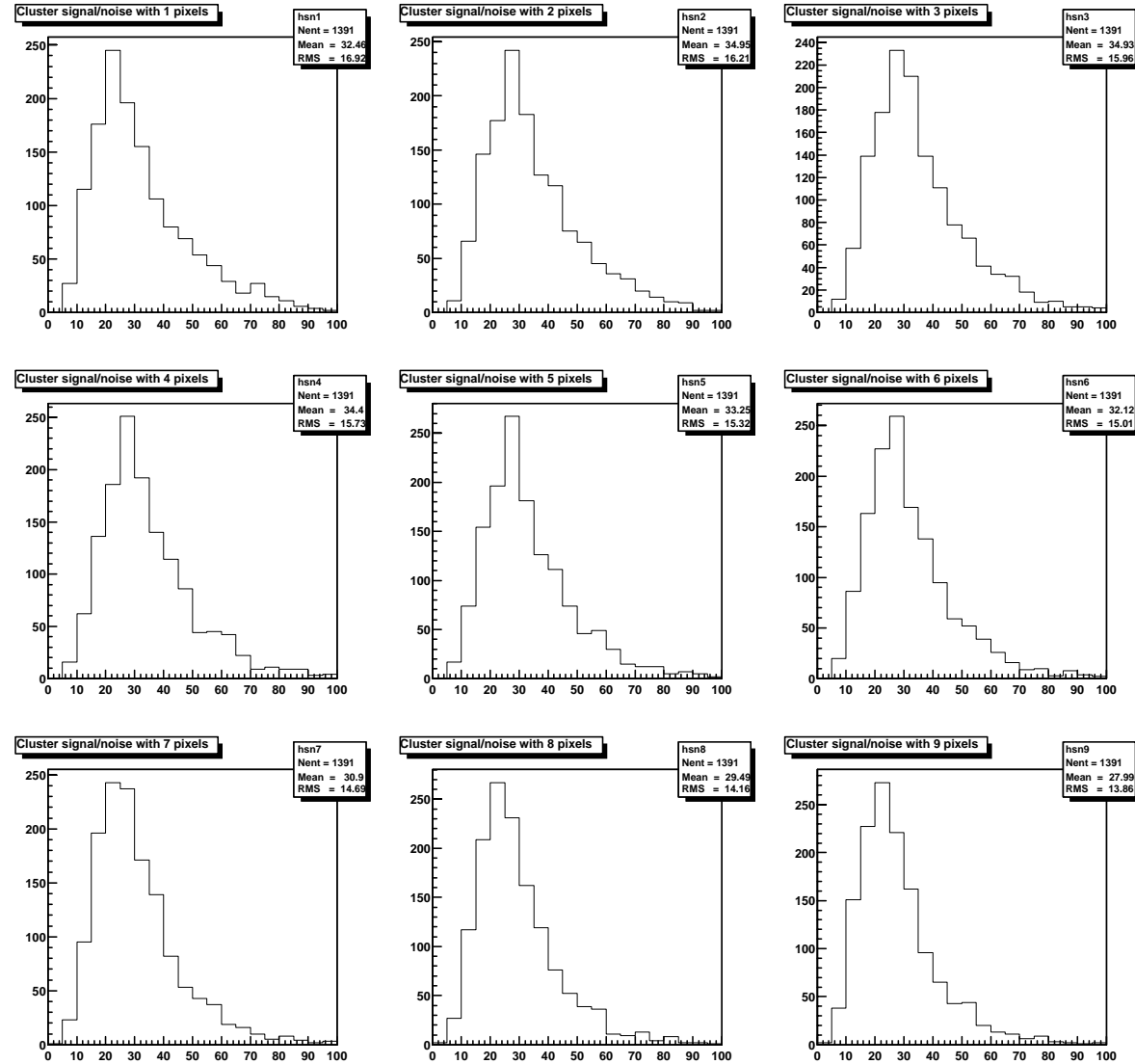

## Cluster selection using maximum individual (event-to-event) S/N ratio : S/N and cluster size distribution

cluster signal/noise

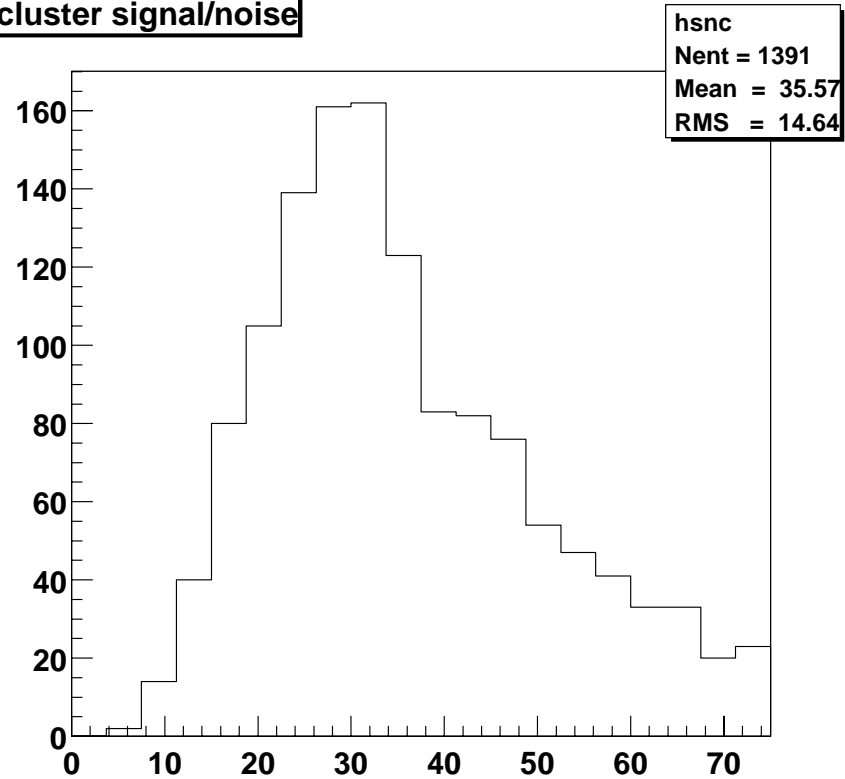

nb pix in cluster

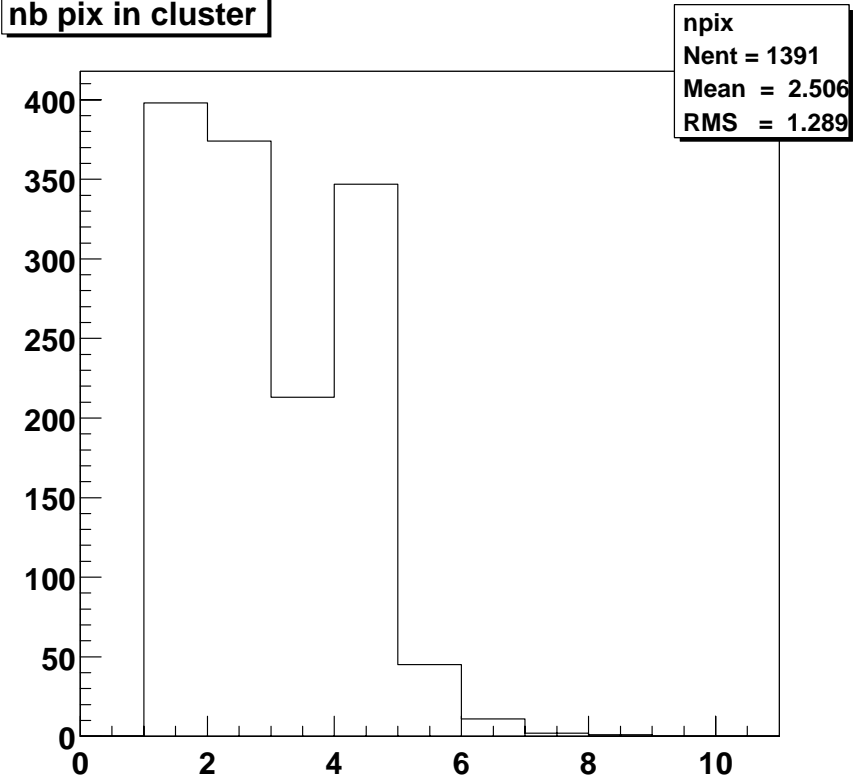

## Tracking tests : reconstruction efficiency

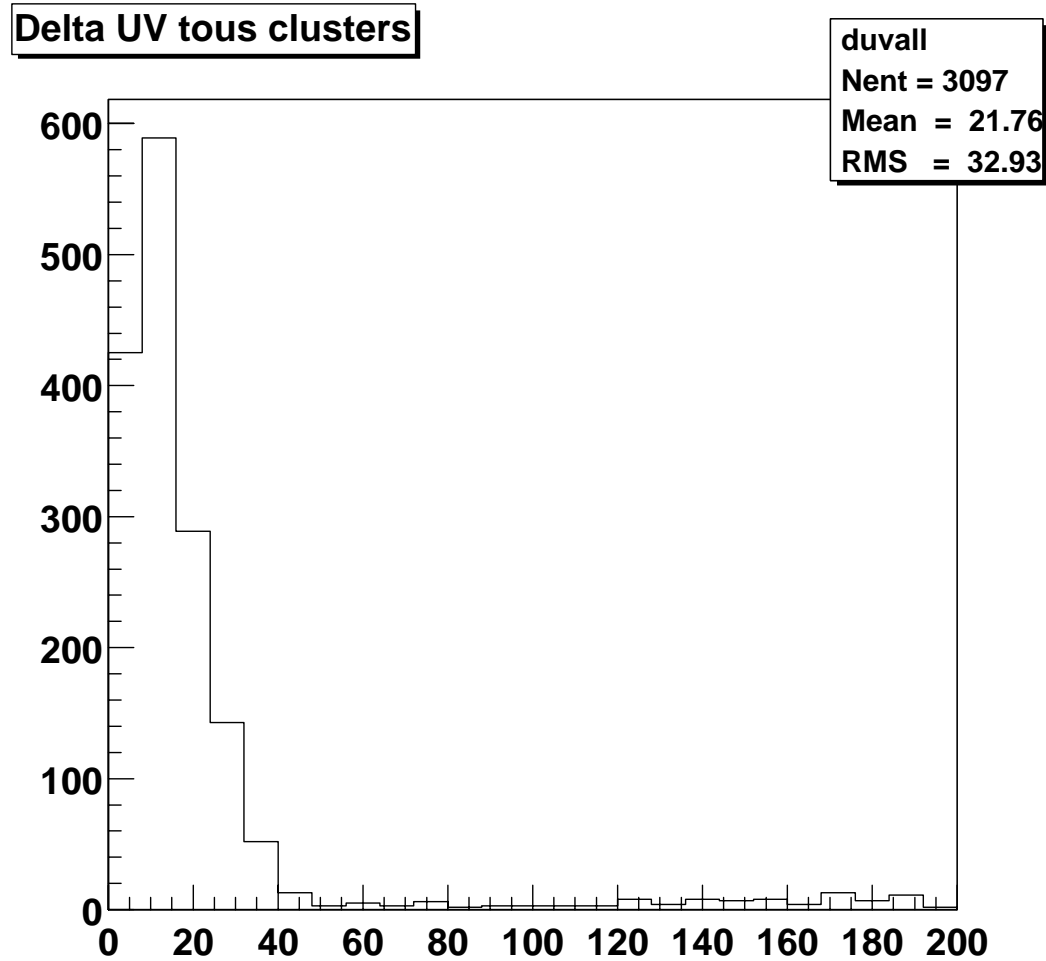

$$\epsilon_{\text{hits} < 50\mu\text{m}} = 99.5 \%$$

## Tracking tests : spatial resolution (binary) (very preliminary, possibly Coulomb scattering dominated)

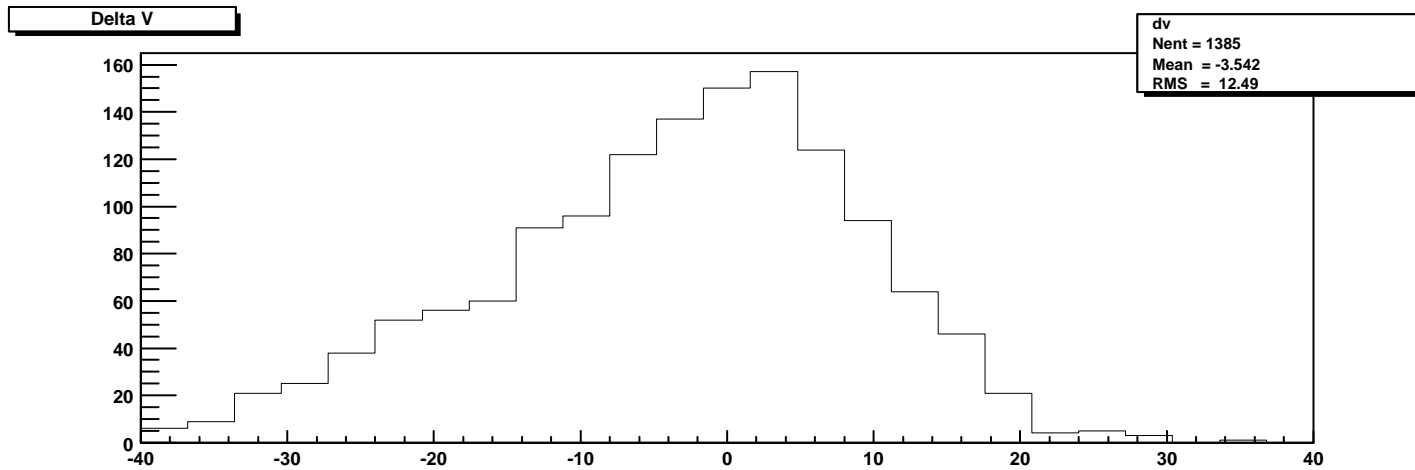
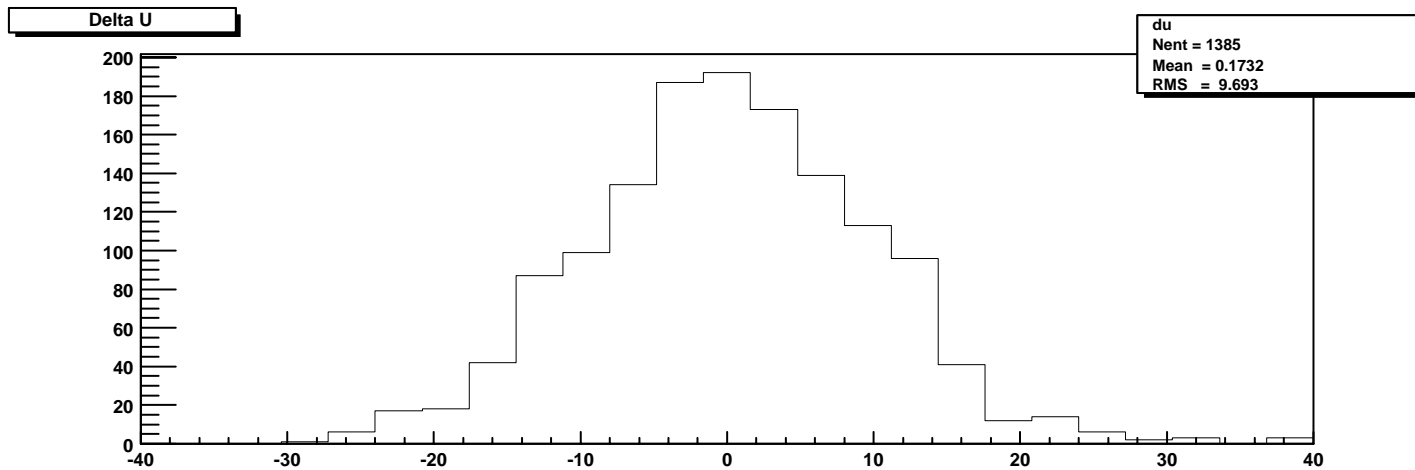

## Conclusion and prospects

- Prototype CMOS MAPS works as a minimum ionising particles detector!
- Charge collection : reasonably fast ( $\sim 100\text{ns}$ ), spread limited to few pixels, good agreement between device simulation and measurements.
- High energy particles beam test results :
  - S/N > 30, 100% detection efficiency,**
  - spatial resolution  $< 10\mu\text{m}$  (hope to get close to  $1\mu\text{m}$ )**
- Near future : rad-tolerant device with some new features (May 2000)
- Medium term future : large area ( $\sim 10\text{ cm}^2$ ) device (beginning of 2001)
- Long term future : intelligent, high precision, ultimately thin, large area and low cost device.
- Other potential application (in addition to MIP tracking):  
single photon imaging (HPD),  $\beta$ -particles imaging, high precision neutron imaging, **scintillator and phosphor screen readout**