



Pixel 2000

International Workshop
on Semiconductor Pixel Detectors
for Particles and X-Rays
June 5-8, 2000
Porto Antico, Genova, Italy



The pixel hybrid photon detectors for the LHCb-RICH project

Thierry GYS

On behalf of the LHCb-RICH group

CERN, Geneva, Switzerland



Outline of the talk



◆ Introduction

- The LHCb detector
- The RICH counters
- Overall RICH system requirements

◆ The pixel hybrid photon detector

- Description
- Full-scale 61-pixel HPD prototypes
- Laboratory and beam test measurements
- Ceramic carrier designs
- Binary front end electronics
- Expected detection efficiency
- Back-scattering and charge sharing effects

◆ Conclusions and perspectives



The LHCb detector (top view)



LHCb is a **single-arm spectrometer** with a forward angular coverage from 10 to 300 mrad, dedicated to **precision studies** of CP asymmetries and of rare decays in the B-meson system

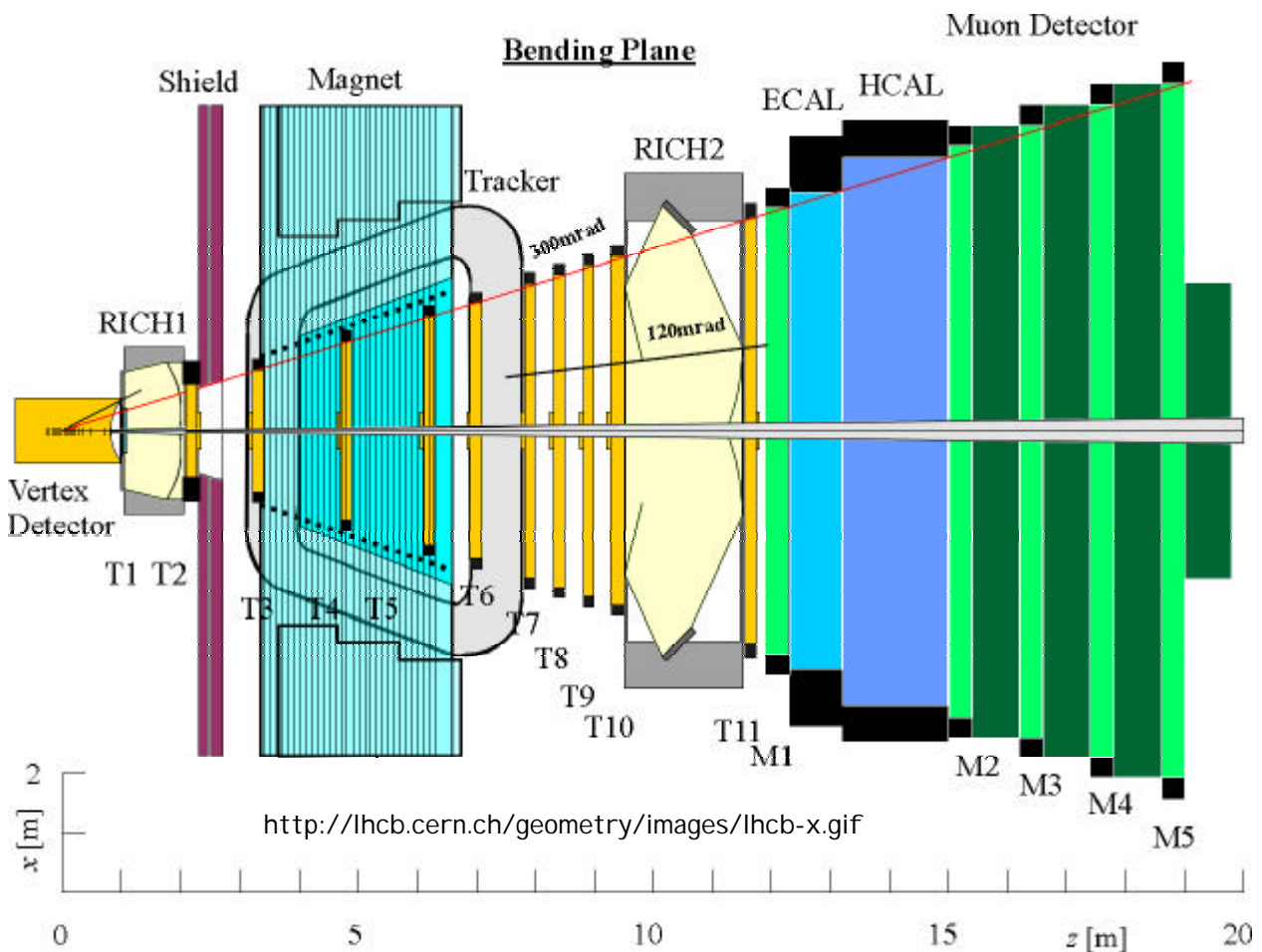

Particle identification over the momentum range 1-150 GeV/c will be achieved by two **Ring Imaging Cherenkov** counters



The RICH 1 counter

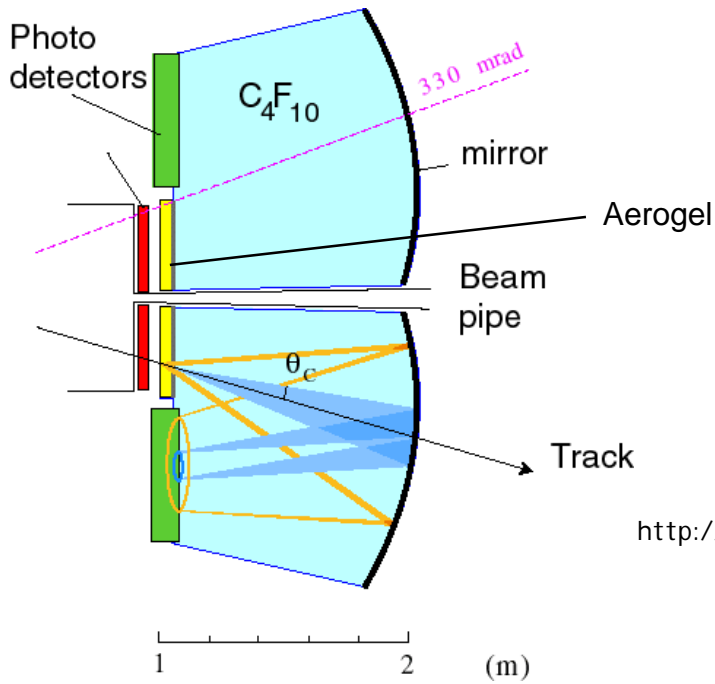

Schematic view

http://lhcb.cern.ch/rich/images/rich1_schematic.gif

Mechanical design studies

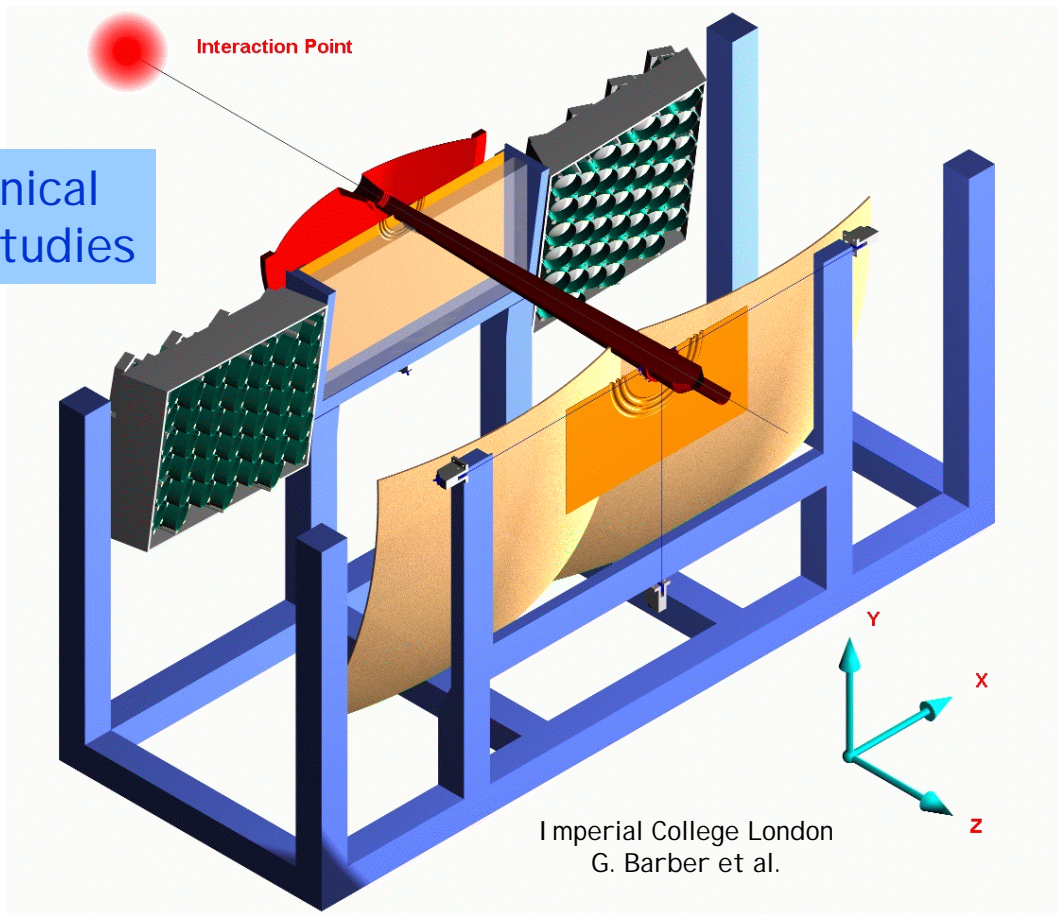



The RICH 2 counter



Schematic view

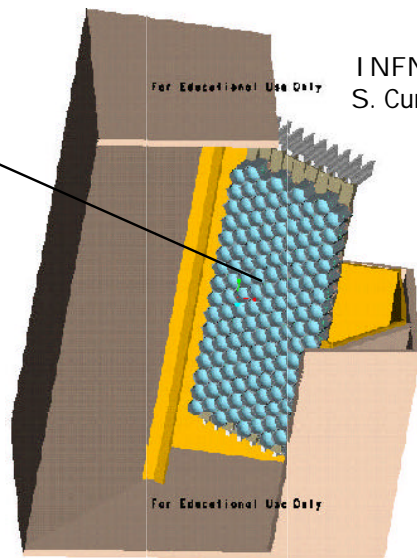
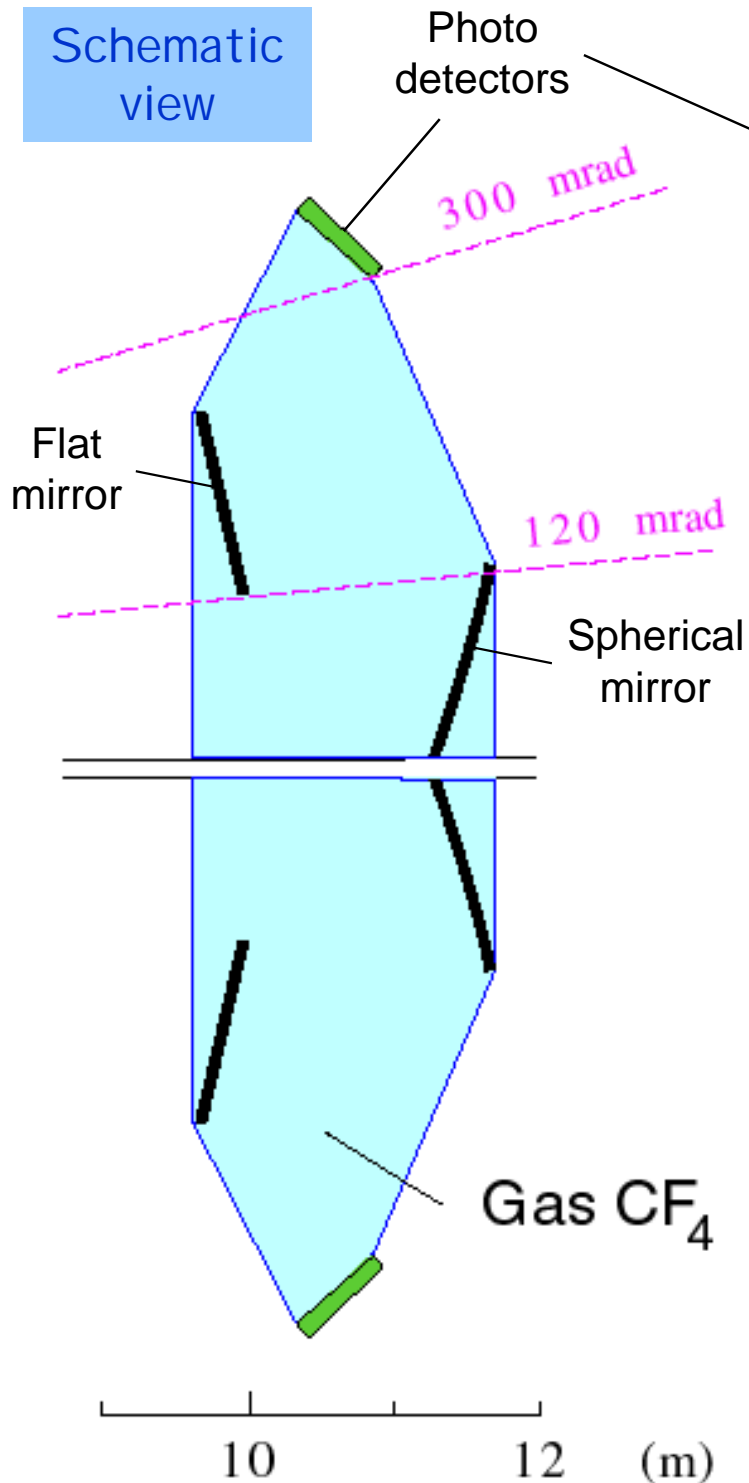

INFN Genova
S. Cuneo et al.

Mechanical design studies

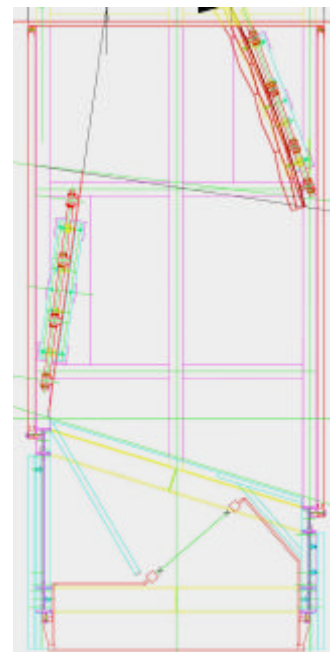

CERN EP-TA2
P. Wicht et al.

http://lhcb.cern.ch/rich/images/rich2_schematic.gif



Overall RICH system requirements



- ◆ Photon detection
 - $\sim 2.9 \text{ m}^2$ total surface
 - Granularity: $2.5 \times 2.5 \text{ mm}^2$
 - Active area coverage $\geq 70 \%$ ($\sim 325'000$ channels)
 - Single-photon sensitivity ($\lambda = 200\text{-}600 \text{ nm}$)

- ◆ Environment
 - Magnetic stray field: $\leq 30 \text{ gauss}$ (RICH1)
 $\leq 100 \text{ gauss}$ (RICH2)
 - Radiation dose: $\leq 3 \text{ kRad/year}$

- ◆ Read-out
 - Maximum occupancy: $\leq 10 \%$
 - BCO identification ($\tau_p \approx 25 \text{ ns}$)
 - High LO-trigger rate (1 MHz)

- ◆ Photo-detectors
 - Pixel-HPDs: baseline solution
cross-focussing geometry
binary pixel readout (this talk)
 - Multi-anode PMTs: backup solution
metal channel dynodes
analogue readout



Pixel-HPD description

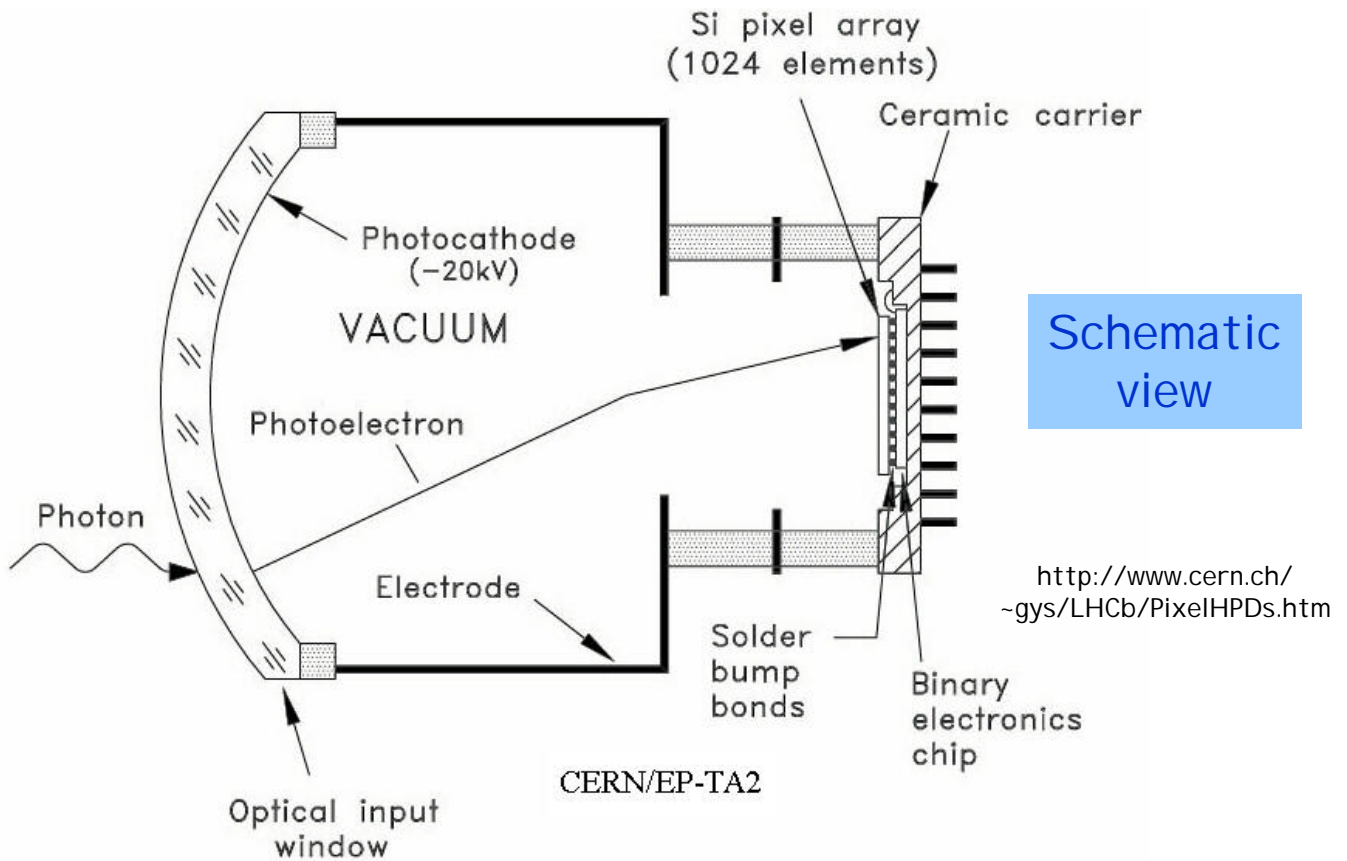

Main features:

Close collaboration with industry

Quartz window with thin S20 pK ($\int QE \cdot dE \approx 0.77 eV$)

Cross-focussing optics (tetrode structure):

- De-magnification by ~ 5
- $50 \mu m$ PSF ($\sim 250 \mu m$ at window level)
- Active diameter $75 mm$ (81.7 % tube coverage)
 $\Rightarrow \sim 450$ tubes for overall RICH system
- $20 kV$ operating voltage ($\sim 5000 e^-$ [eq. Si])

32×32 pixel sensor array ($500 \mu m \times 500 \mu m$ each)

Encapsulated binary electronics readout chip



Full-scale 61-pixel HPD prototypes



Manufactured by *DEP B.V.* (The Netherlands)

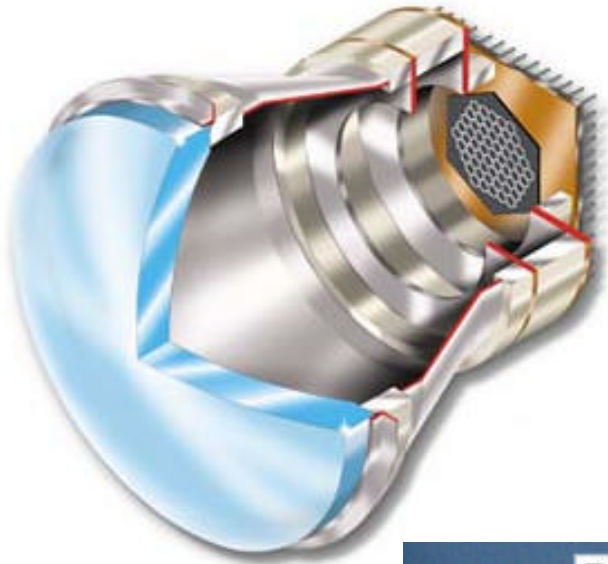

3D schematic
view

<http://www.dep.nl/prodline/a182.jpg>

Actual
prototype

<http://www.cern.ch/~gys/LHCb/PixelHPDs.htm>

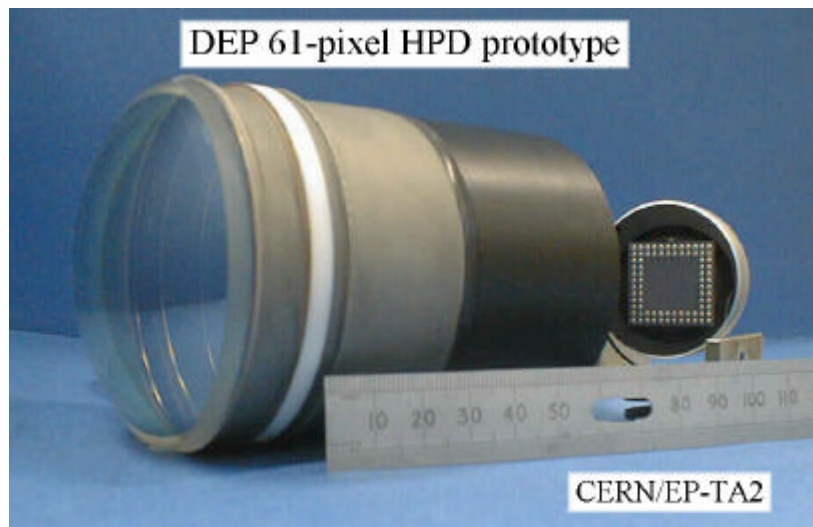

Preliminary tests at the factory were satisfactory:

20 kV high voltage operation

17% QE @ $\lambda = 400$ nm

Si detector leakage current: ≤ 1 nA per pixel



Full-scale 61-pixel HPD prototypes (cont'd)



Laboratory measurements

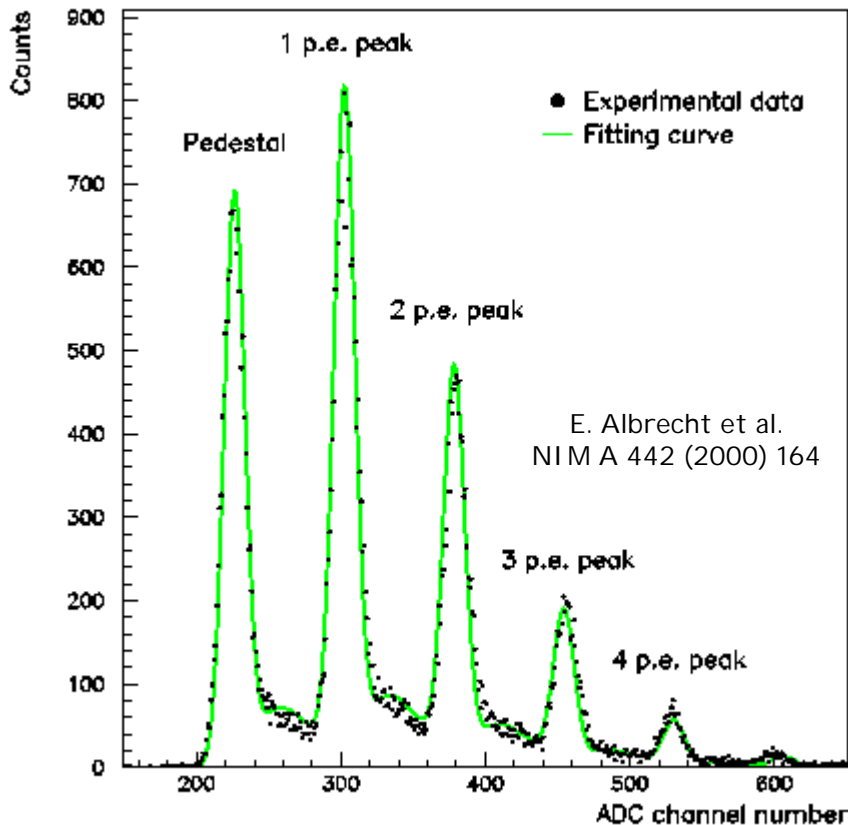

Pulsed LED spectrum

Single photoelectron response:

Signal-to-noise ratio ≈ 11 @ 20 kV

with external analogue VA2 readout ($\tau_p = 1.2 \mu s$)
(E. Albrecht et al., NIM A 411 (1998) 249)

E- optics performance:

Confirmed



Full-scale 61-pixel HPD prototypes (cont'd)



Beam tests

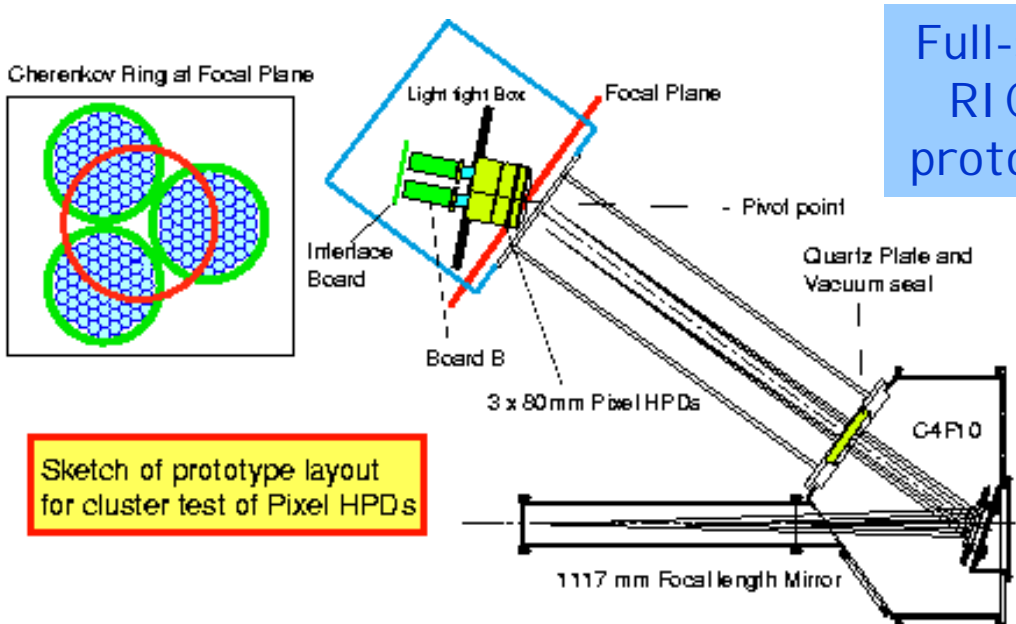

Full-scale RICH1 prototype

Sketch of prototype layout for cluster test of Pixel HPDs

Cherenkov angle is 53 mrad with C4F10 radiator at 1000mbar

http://lhcb.cern.ch/rich/images/RICH_proto_layout_pixel_cluster.gif

E. Albrecht et al.
NIM A 442 (2000) 164

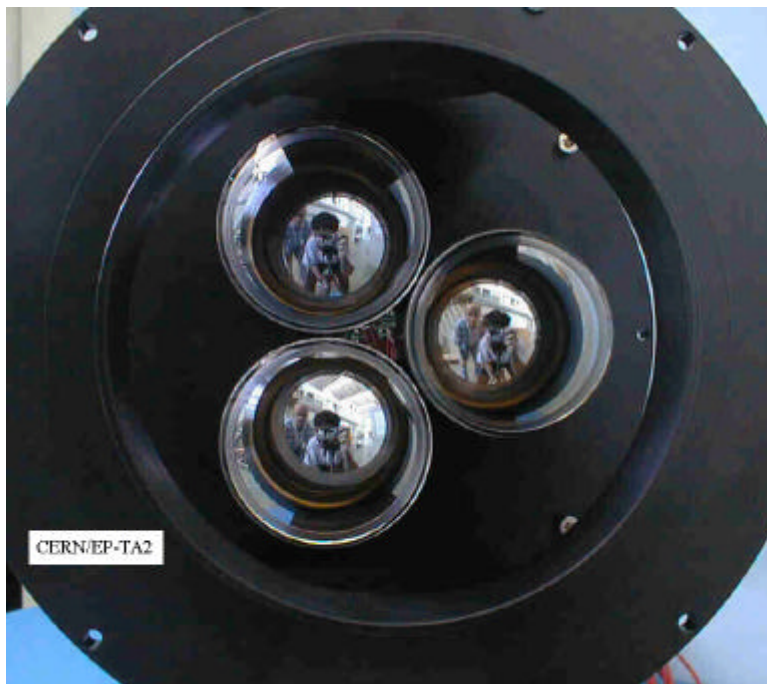

61-pixel HPD cluster

<http://www.cern.ch/~gys/LHCb/PixelHPDs.htm>



Full-scale 61-pixel HPD prototypes (cont'd)



Accumulated Cherenkov rings

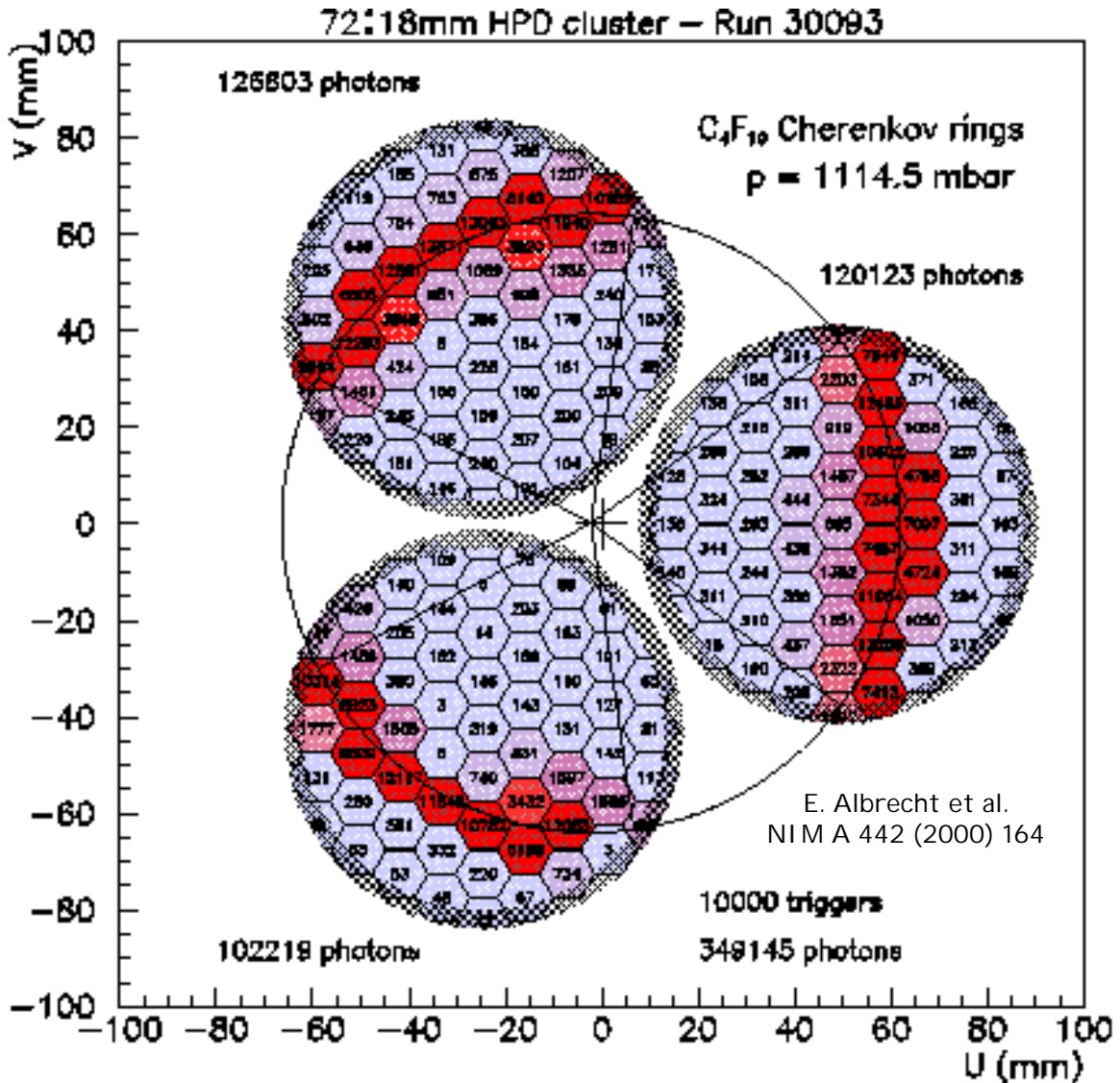

Tube figure of merit:

$$N_0 \approx 225-250 \text{ cm}^{-1}$$



Ceramic carrier designs

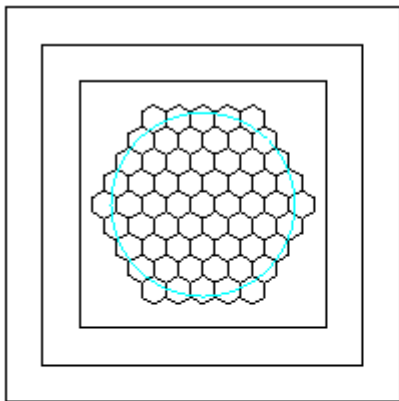

TOP
VIEW

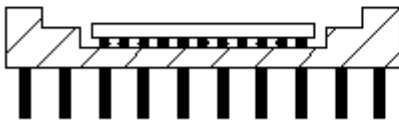

SIDE
VIEW

1st HPD prototype:

Commercial 61-pixel anode
External VA2 readout
($\tau_p = 1.2\mu s$)
~65 feed-throughs

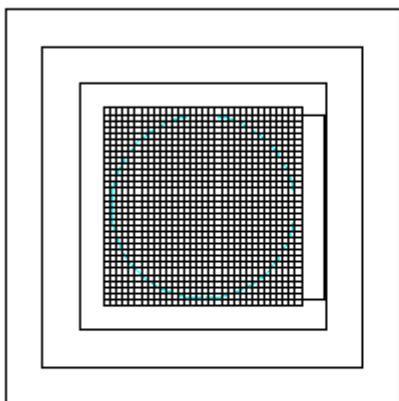

TOP
VIEW

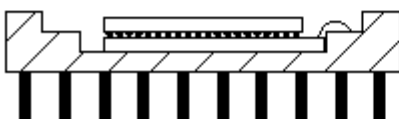

SIDE
VIEW

Final HPD prototype:

Custom 1024-pixel anode
Internal binary readout
($\tau_p = 25ns$)
~100 feed-throughs

+ Bake-out compatibility
(5h @ 350°C)
+ Power dissipation
(≤ 0.5 W for binary
electronics)



Ceramic carrier designs (cont'd)



Manufactured by *Kyocera* (Japan)

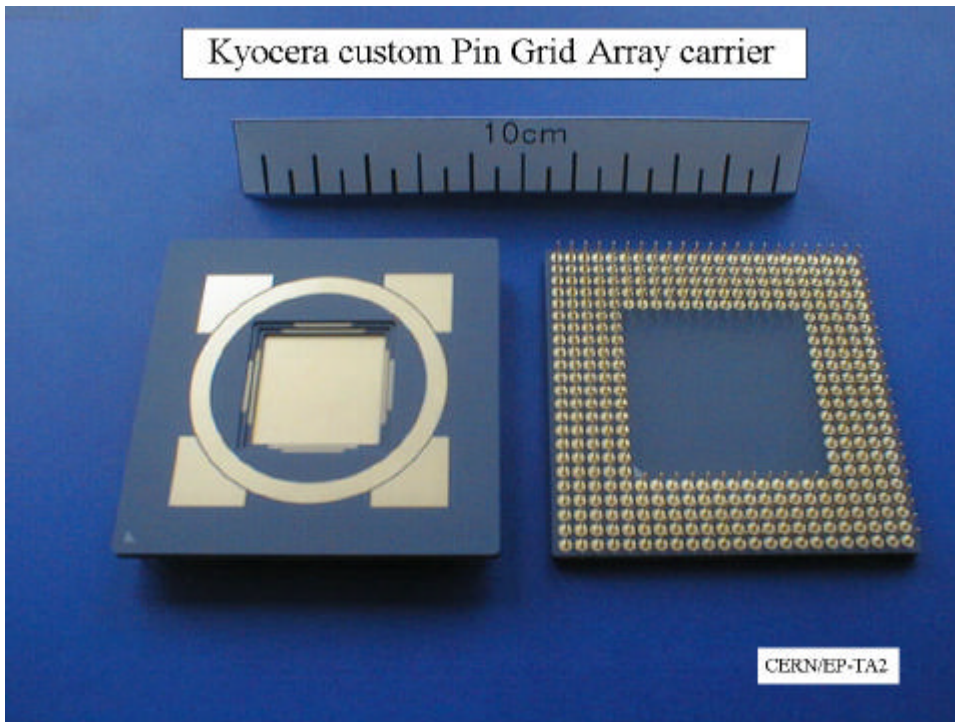

Custom Pin Grid Array carrier for the ALICE-LHCb chip

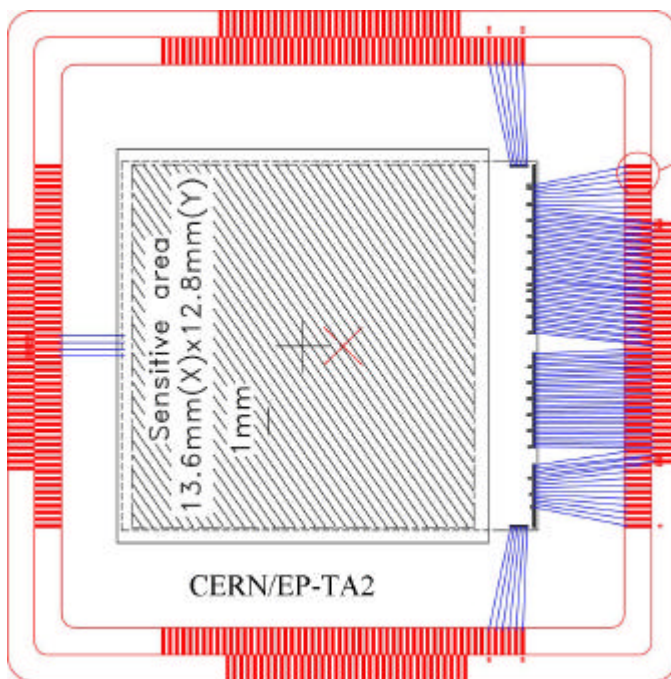

ALICE-LHCb chip within carrier cavity

~100 finger bond pads (out of 360) used



Binary front end electronics (baseline specifications)

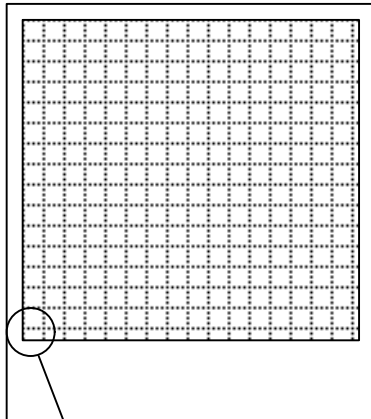

Full readout chip

32 × 32 super-pixel array
16mm × 16mm active area
40MHz readout clock
⇒ ~800ns readout time
complying with LHCb LO
trigger rate (1MHz)

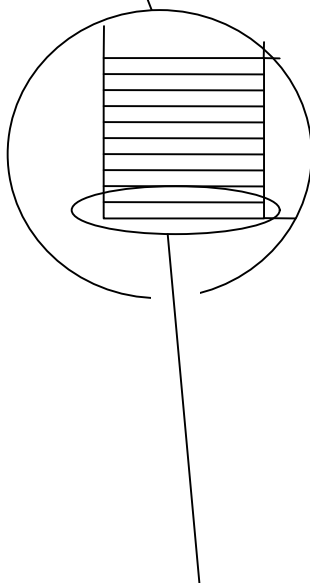

Super-pixel

500µm × 500µm area
10 sub-pixels ORed together
Digital FE electronics:
• 20 delay lines (4µs)
• 16-deep FIFO de-randomizing buffer
⇒ reduced occupancy seen by
analogue FE and lower noise

Sub-pixel

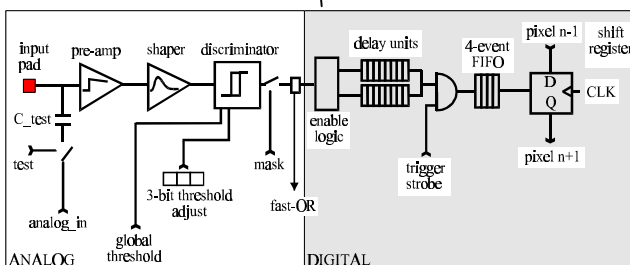

50µm × 500µm area
Analogue FE electronics:
• Differential amplifier (250 e⁻ noise)
• Shaper (25 ns peaking time)
• Discriminator (2000 e⁻ aver.,
30 e⁻ spread with 3-bit adjust)

http://nicewww.cern.ch/~lebworkshop/LEB99_Book/Tracker/Wyllie.pdf
See also contribution of W. Snoeys (this workshop)



Expected detection efficiency



Pedestal Cut Signal

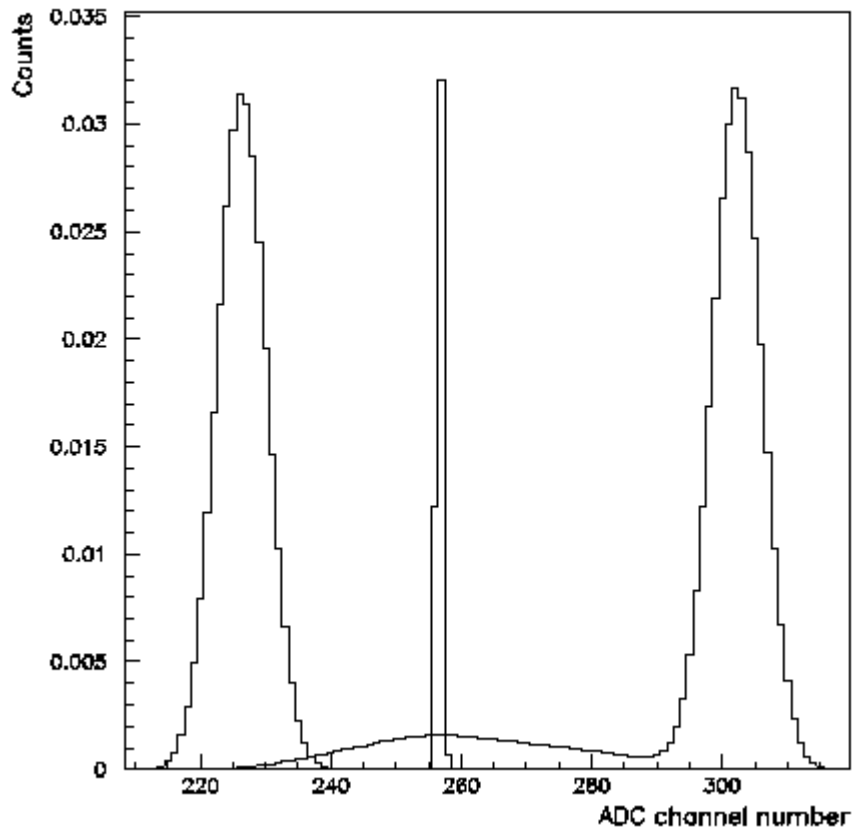

- Pedestal: 250 e^- RMS noise
- Cut: 2000 e^- aver., 30 e^- RMS spread
- Signal: 5000 e^- @ full energy
+ 18 % back-scattering

⇒ ~90 % detection efficiency



Back-scattering and charge sharing effects



Charge sharing

7 μm RMS lateral spread
(300 μm -thickness,
90 V bias)

Not significant if $E_{\text{cut}} < E_0/2$

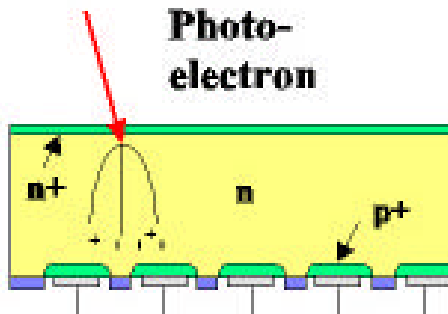

Back-scattering

18% probability

$\langle E \rangle = E_0/2$

Reduced effect if low cut

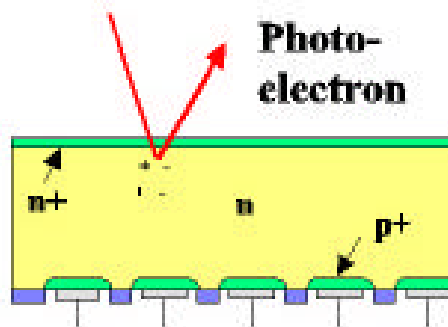



Conclusions and perspectives



◆ Prototype tubes and electronics

■ Close collaboration with industry:

- reliability
- easier transition to production

■ Binary electronics implies:

- lower cost
- simpler readout architecture, data transmission and processing

◆ Successful R&D results

- Electron optics provide large tube active area
- High quantum efficiency photo-cathodes
- Cherenkov air and gas rings successfully detected in various LHCb RICH prototypes
- Test pixel electronics provides optimized detection efficiency, same performance expected with full chip

◆ Current and future R&D work

- HPD prototype with encapsulated ALICE-LHCb chip (milestone winter 2000)
- LHCb-RICH Technical Design Report (submission autumn 2000)
- Final LHCb chip and ceramic carrier design (submission spring 2001)
- Final HPD prototype (completion winter 2001)