

Resonances: Deciphering the signature of QCD

S. Krewald

Forschungszentrum Jülich



Bethe Center for
Theoretical Physics

Athos 2012
June 21, 2012



Not every bump is a resonance and not every resonance is a bump.

Moorhouse 1960ties



How three-body unitarity induces hadron exchange

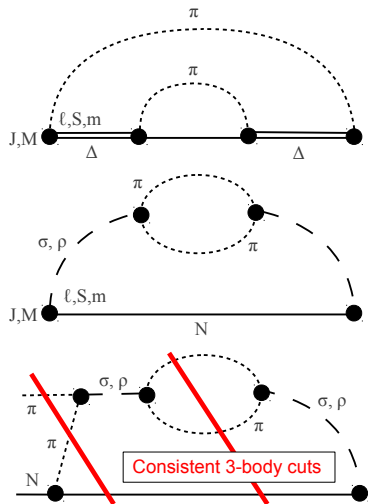

- $\pi\pi/\pi N$ subsystems fit the respective phase shifts.
- Consistent inclusion of 3-body cuts.
- Allows for *a-priori* 3-body unitarity per construction

[Aron, Almodo, Young, PR 174 (1968) 2022].

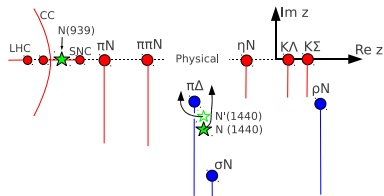

- $N(\pi\pi)_{L=I=0}$ channel important (chiral σ); Roper dynamically generated in Jülich model.
- Roper pole $N(1440) + \pi\Delta$ branch point \rightarrow non-standard resonance shape.
- Sub-threshold cuts from crossing symmetry.

- Where is the $3^* N(1710)$? [S. Ceci, M.D. et al., PRC 84 (2011)]

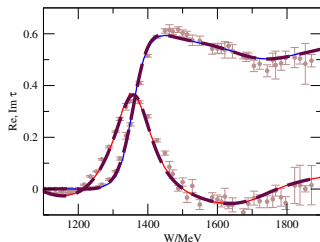

Fit of a model without ρN branch point (CMB type) [solid lines] to the Jülich amplitude [dashed lines]

- CMB fit to JM has pole at $1698 - 130 i$ MeV, simulates missing branch point.
- \rightarrow Inclusion of full analytic structure important to avoid false pole signals.

Crossing symmetry

at the level of the potential (not the amplitude)

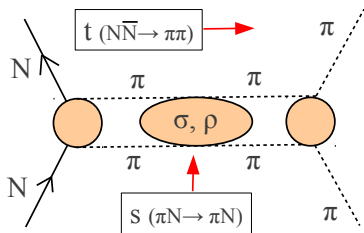

- πN t -channel interaction from $\bar{N}N \rightarrow \pi\pi$ (analytically continued) data, for $\sigma(600)$ and $\rho(770)$ quantum numbers.
- Use of crossing symmetry and dispersion techniques

[Schütz *et al.* PRC 49 (1994) 2671].

Hadron exchange (Jülich approach)

Scattering equation in the JLS basis

$$\langle L' S' k' | T_{\mu\nu}^{IJ} | L S k \rangle = \langle L' S' k' | V_{\mu\nu}^{IJ} | L S k \rangle + \sum_{\gamma, L'' S''} \int_0^{\infty} k''^2 dk'' \langle L' S' k' | V_{\mu\gamma}^{IJ} | L'' S'' k'' \rangle \frac{1}{Z - E_{\gamma}(k'') + i\epsilon} \langle L'' S'' k'' | T_{\gamma\nu}^{IJ} | L S k \rangle$$

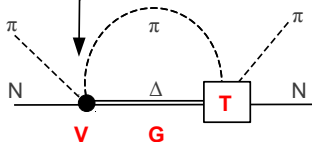
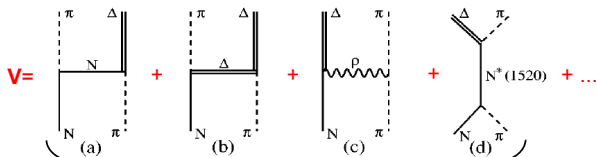

Hadron exchange (Jülich approach)

Scattering equation in the JLS basis

$$\langle L' S' k' | T_{\mu\nu}^{IJ} | L S k \rangle = \langle L' S' k' | V_{\mu\nu}^{IJ} | L S k \rangle + \sum_{\gamma, L'' S''} \int_0^{\infty} k''^2 dk'' \langle L' S' k' | V_{\mu\gamma}^{IJ} | L'' S'' k'' \rangle \frac{1}{Z - E_{\gamma}(k'') + i\epsilon} \langle L'' S'' k'' | T_{\gamma\nu}^{IJ} | L S k \rangle$$

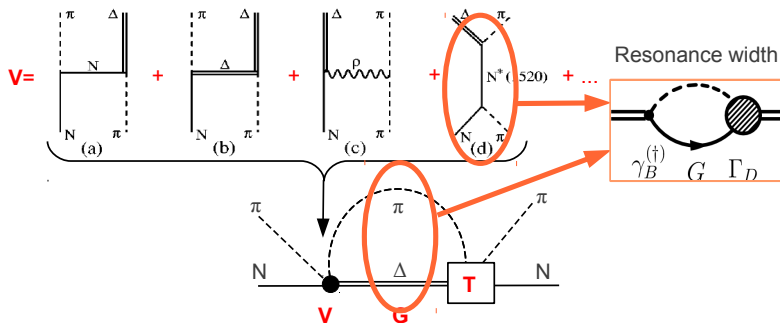

Hadron exchange (Jülich approach)

Scattering equation in the JLS basis

$$\langle L' S' k' | T_{\mu\nu}^{IJ} | L S k \rangle = \langle L' S' k' | V_{\mu\nu}^{IJ} | L S k \rangle + \sum_{\gamma, L'' S''} \int_0^{\infty} k''^2 dk'' \langle L' S' k' | V_{\mu\gamma}^{IJ} | L'' S'' k'' \rangle \frac{1}{Z - E_{\gamma}(k'') + i\epsilon} \langle L'' S'' k'' | T_{\gamma\nu}^{IJ} | L S k \rangle$$

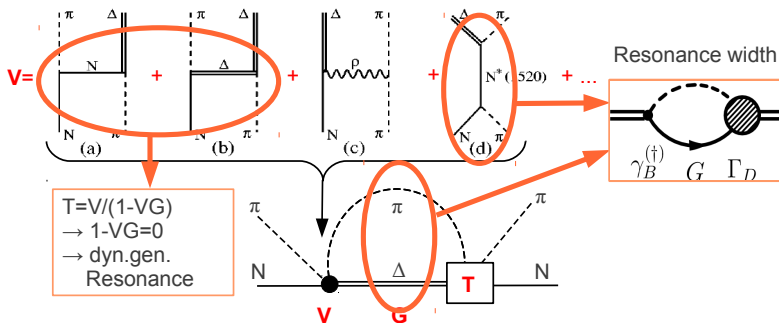

$$\langle L' S' k' | T_{\mu\nu}^{IJ} | L S k \rangle = \langle L' S' k' | V_{\mu\nu}^{IJ} | L S k \rangle + \sum_{\gamma, L'' S''} \int_0^{\infty} k''^2 dk'' \langle L' S' k' | V_{\mu\gamma}^{IJ} | L'' S'' k'' \rangle \frac{1}{Z - E_{\gamma}(k'') + i\epsilon} \langle L'' S'' k'' | T_{\gamma\nu}^{IJ} | L S k \rangle$$

Features

- Coupled channels πN , ηN , $K\Lambda$, $K\Sigma$, $\pi\pi N$ [$\pi\Delta$, σN , ρN].
- Full analyticity (dispersive parts).
- 2-body unitarity, some requirements of 3-body unitarity.
- Chiral Lagrangian of Wess and Zumino [PR163 (1967), Phys.Rept. 161 (1988)].
 - Hadron exchange provides the relevant dynamics.
 - All partial waves are linked (t-, u-channel processes).
 - Channels/reactions linked (SU(3) symmetry in Lagrangian framework).
- Minimal # of explicit resonances (s -channel) needed due to structured background.

