

**Recent results on pi-pi amplitudes
at BES III**

Beijiang LIU

(For BES III collaboration)

Institute of High Energy Physics, China

ATHOS12, Camogli Italy





Linac

Storage ring

Beam energy 1.0-2.3 GeV
Energy spread: 5.16×10^{-4}

Design luminosity
 $1 \times 10^{33}/\text{cm}^2/\text{s}$ @ $\psi(3770)$

BES III

(Beijing Spectrometer)

BSRF

BEPC II

(Beijing Electron-positron collider)

2008: test run

2009 : **106 M $\psi(2S)$** (x4 CLEO-c),
225 M J/ ψ (x4 BESII)

2010 : 900 pb^{-1} $\psi(3770)$

2011 : 1800 pb^{-1} $\psi(3770)$,
470 pb^{-1} @ 4.01 GeV

2012 : **0.4 billion $\psi(2S)$,**
1 billion J/ ψ

Physics Programs @ BESIII

Light hadron physics

• meson & baryon spectroscopy

- multiquark states, glueballs & hybrids

- ◆ Gluon-rich process

- ◆ I, J^{PC} filter

- two-photon physics
- form-factors

Charmonium physics:

- precision spectroscopy
- transitions and decays
- XYZ meson physics:
 - $Y(4260)$: $\pi \pi h c$ decays

The BESIII Detector

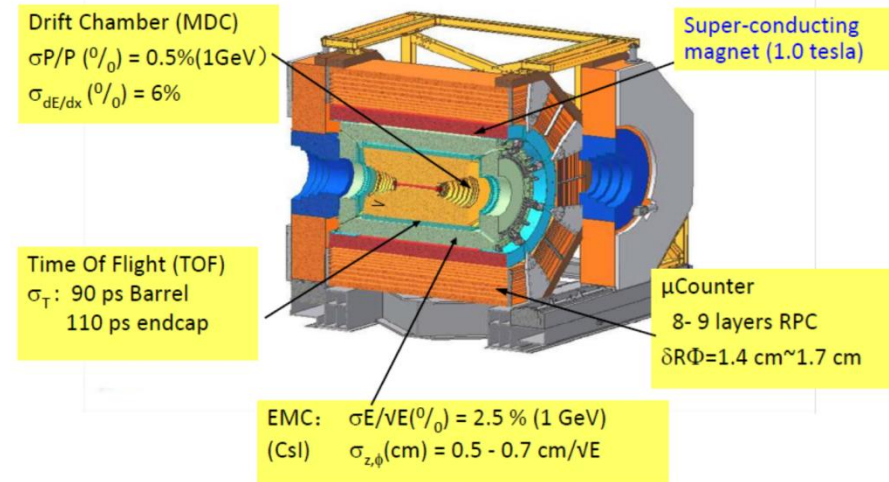

Charm physics:

- (semi-)leptonic form factors
- f_D & f_{D_s} decay constants.
- CKM matrix: V_{cd} , V_{cs}
- D^0 - D^0 bar mixing and CPV
- strong phases

QCD & tau-physics:

- precision R-measurement
- tau mass / tau decays

Precision measurement of the branching fractions of $J/\psi \rightarrow \pi^+\pi^-\pi^0$ and $\psi' \rightarrow \pi^+\pi^-\pi^0$

BES III, Phys.Lett. B710 (2012) 594

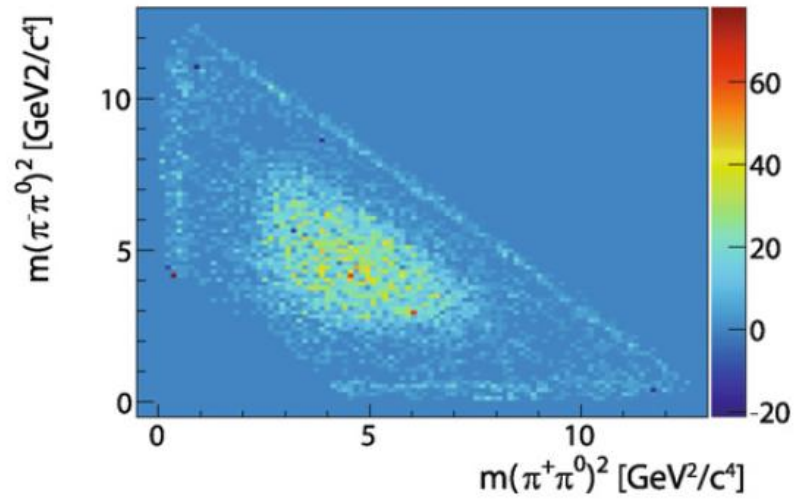
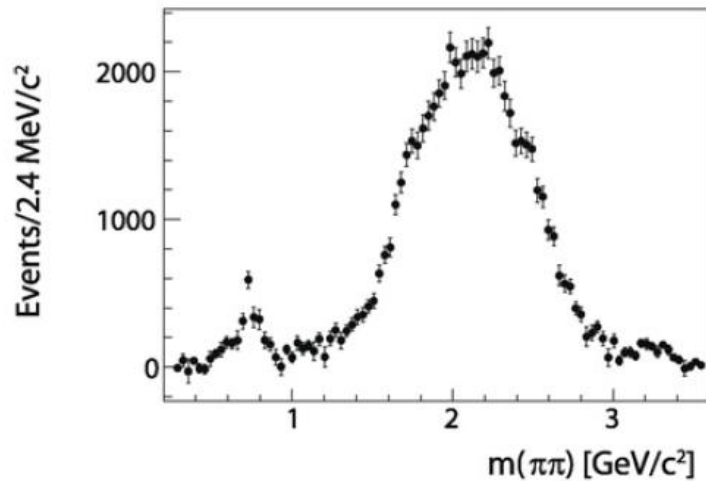
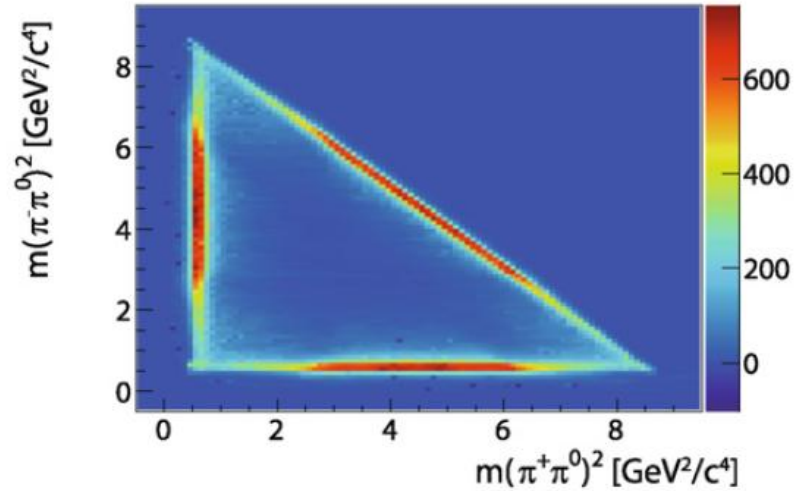
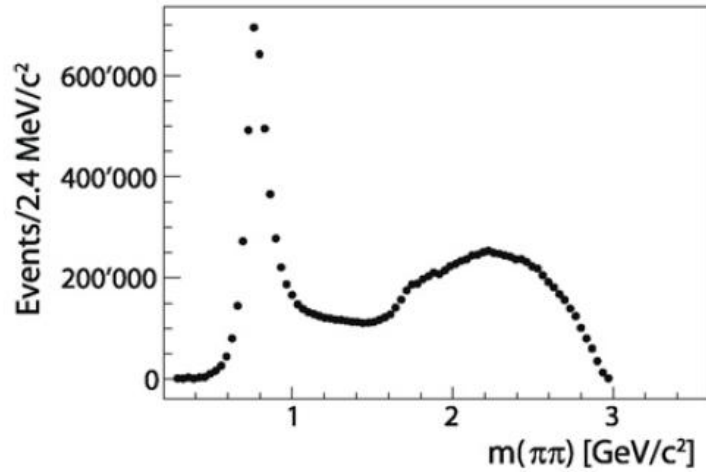

Isospin-violating decay of $J/\psi \rightarrow \gamma\pi\pi\pi$

BES III, Phys. Rev.Lett. 108, (2012) 182001

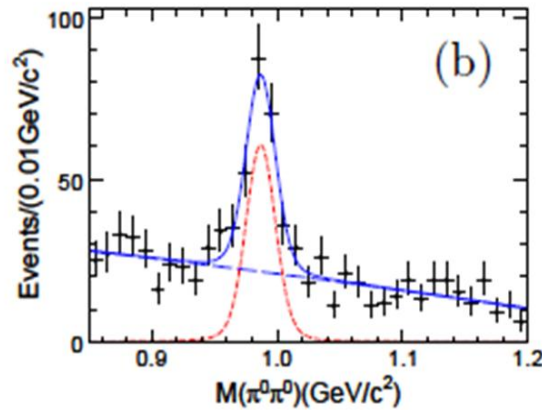
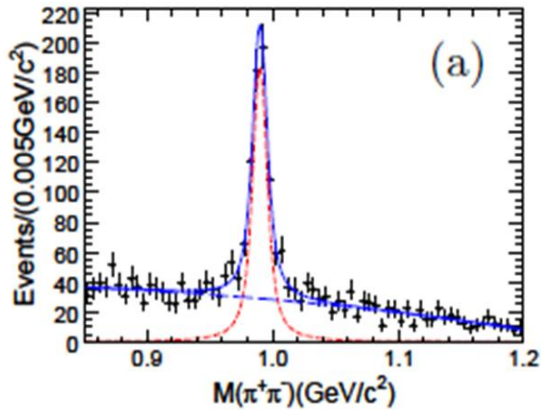
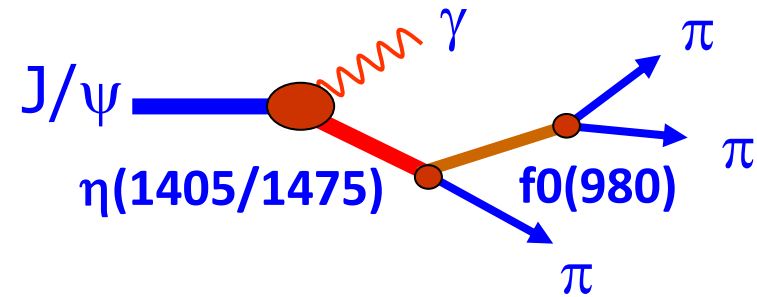
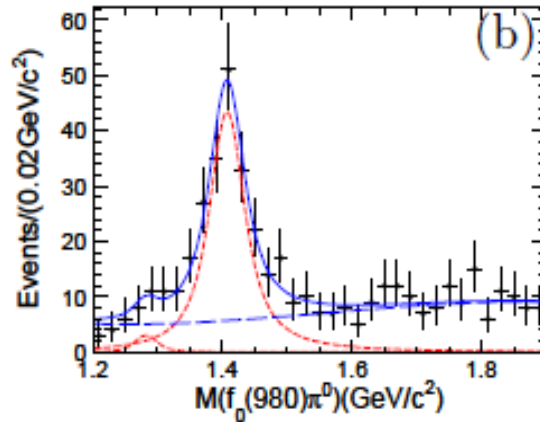
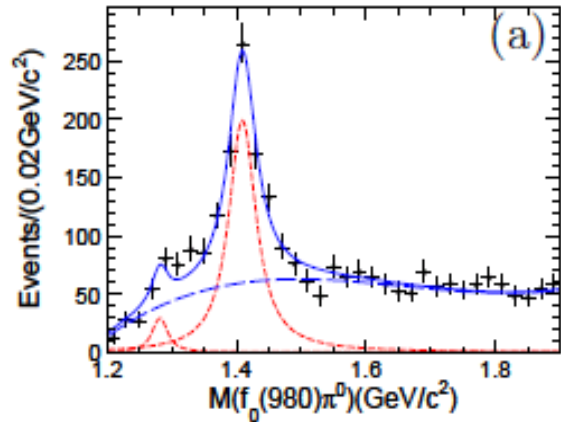

Isospin-violating decay of $J/\psi \rightarrow \gamma\pi\pi\pi$
newly appeared in PDG review 2012

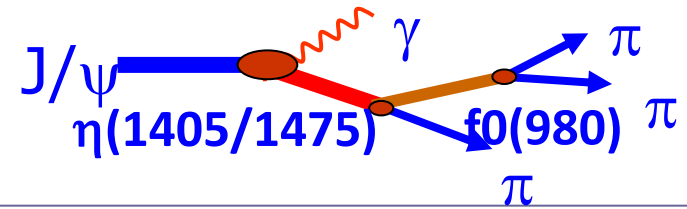

$f_0(980)$ is extremely narrow: $\Gamma \cong 10$ MeV.
PDG: $\Gamma(f_0(980)) \cong 40 \sim 100$ MeV.

Anomalously large isospin violation:

$$\frac{Br(\eta(1405) \rightarrow f_0(980)\pi^0 \rightarrow \pi^+\pi^-\pi^0)}{Br(\eta(1405) \rightarrow a_0^0(980)\pi^0 \rightarrow \eta\pi^0\pi^0)} \cong (17.9 \pm 4.2)\%$$

$$\xi_{af} = \frac{Br(\chi_{c1} \rightarrow f_0(980)\pi^0 \rightarrow \pi^+\pi^-\pi^0)}{Br(\chi_{c1} \rightarrow a_0(980)\pi^0 \rightarrow \eta\pi^0\pi^0)} < 1\% (90\% C.L.)$$

PRD, 83(2100)032003

J.J. Wu, X.H. Liu, Q.Z. and B.S. Zou, PRL(2012)

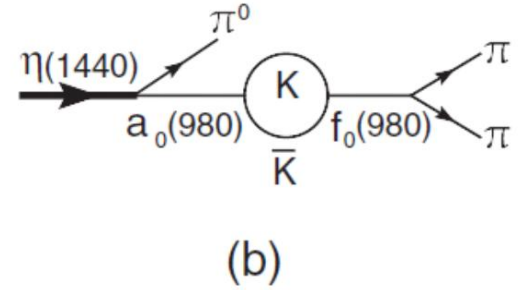
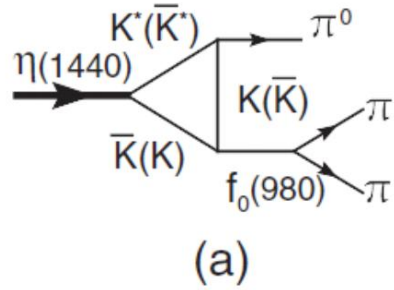

$J/\psi \rightarrow \gamma \pi \pi$ @ BES II, Phys. Lett. B642 (2003) 441

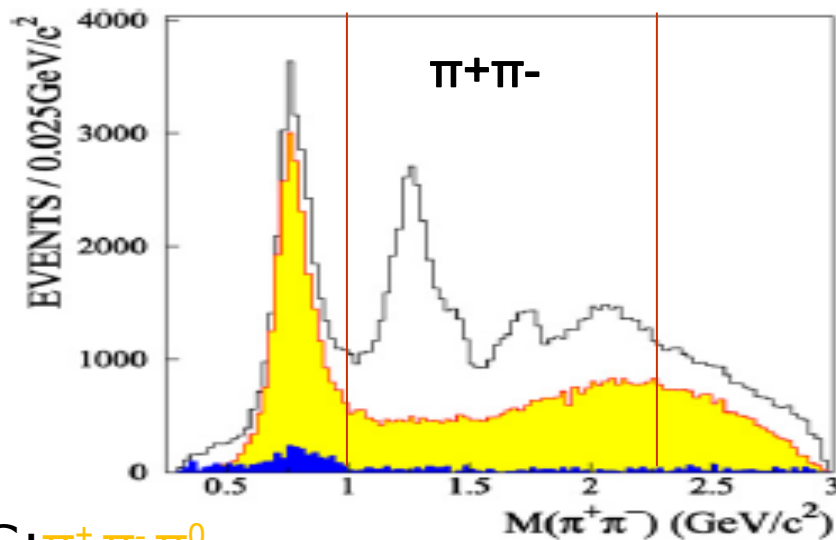

BG: $\pi^+ \pi^- \pi^0$,
 $\gamma \eta$, $K^* K$, etc.

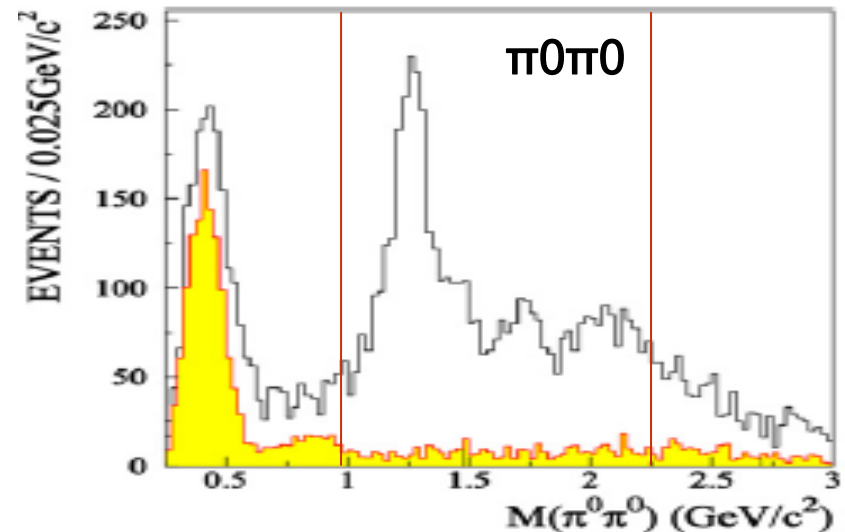

BG: $\gamma \eta$,
 $\omega \pi^0 \pi^0$,
 $\gamma \pi^0 \pi^0$, etc.

	$J/\psi \rightarrow \gamma X, X \rightarrow \pi^+ \pi^-$		
	Mass (MeV/c ²)	Γ (MeV/c ²)	\mathcal{B} ($\times 10^{-4}$)
$f_2(1270)$	$1262^{+1}_{-2} \pm 8$	$175^{+6}_{-4} \pm 10$	$9.14 \pm 0.07 \pm 1.48$
$f_0(1500)$	$1466 \pm 6 \pm 20$	$108^{+14}_{-11} \pm 25$	$0.67 \pm 0.02 \pm 0.30$
$f_0(1710)$	$1765^{+4}_{-3} \pm 13$	$145 \pm 8 \pm 69$	$2.64 \pm 0.04 \pm 0.75$
	$J/\psi \rightarrow \gamma X, X \rightarrow \pi^0 \pi^0$		
	Mass (MeV/c ²)	Γ (MeV/c ²)	\mathcal{B} ($\times 10^{-4}$)
$f_2(1270)$	same as charged channel		$4.00 \pm 0.09 \pm 0.58$
$f_0(1500)$	same as charged channel		$0.34 \pm 0.03 \pm 0.15$
$f_0(1710)$	same as charged channel		$1.33 \pm 0.05 \pm 0.88$

$J/\psi \rightarrow \gamma \pi^0 \pi^0$ @ BES III

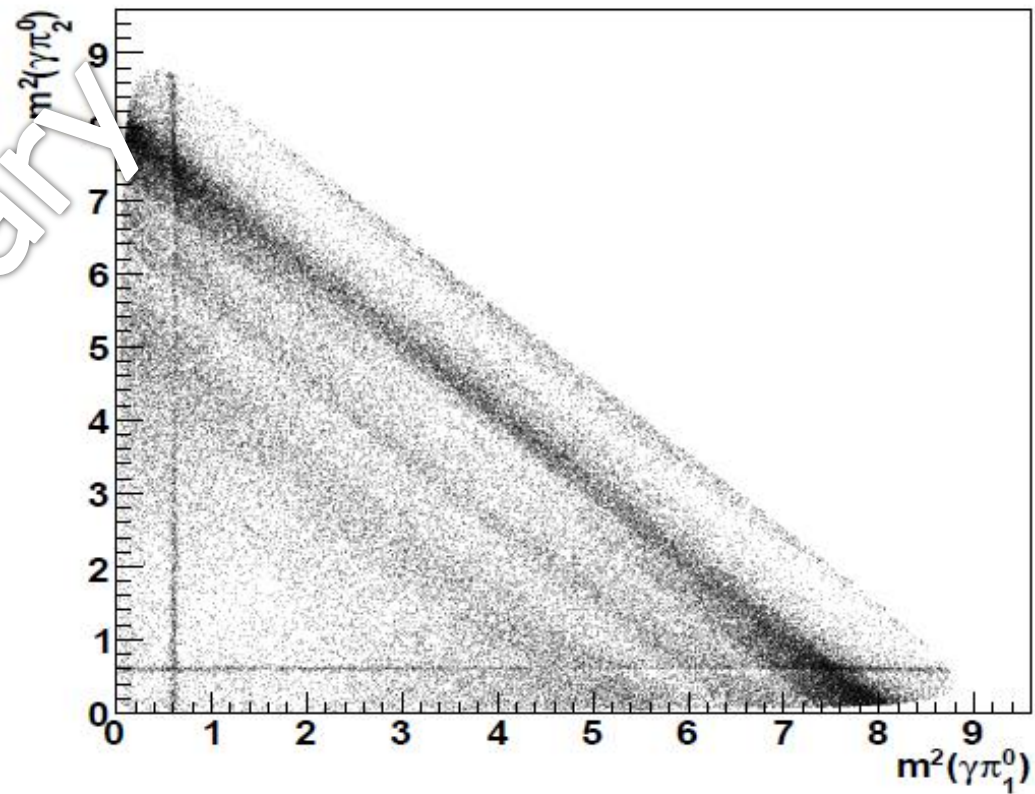
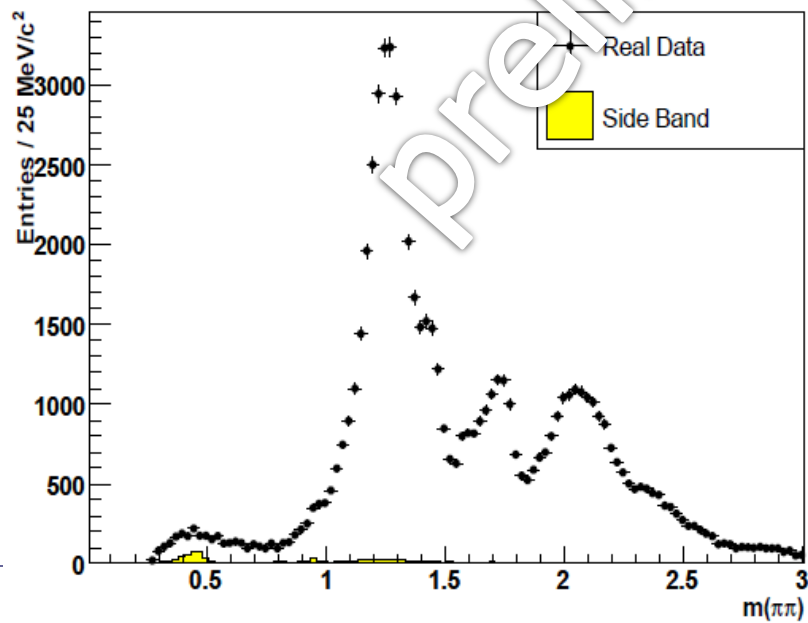
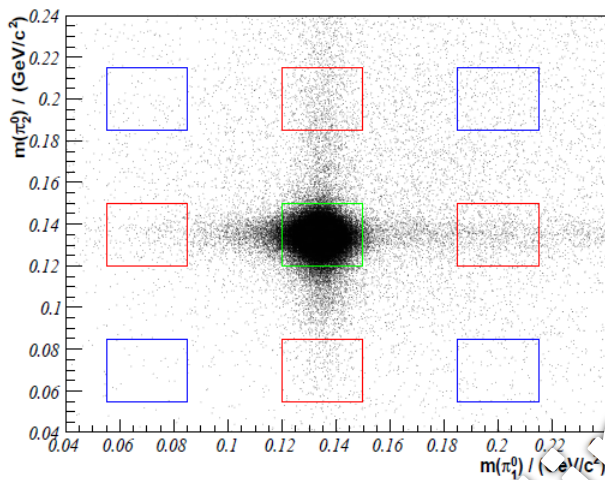

Preliminary PWA results of $J/\psi \rightarrow \gamma \pi^0 \pi^0$

covariant tensor formalism, Zou & Bugg, Eur.Phys.J. A16, 537
event-wise ML fit with isobar model (BW)

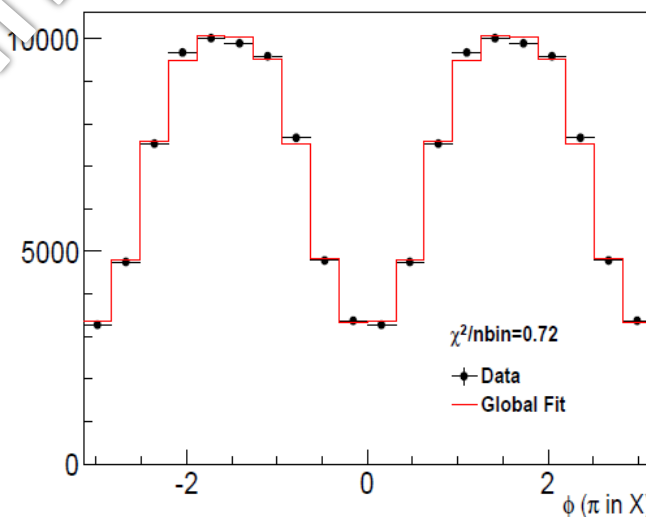
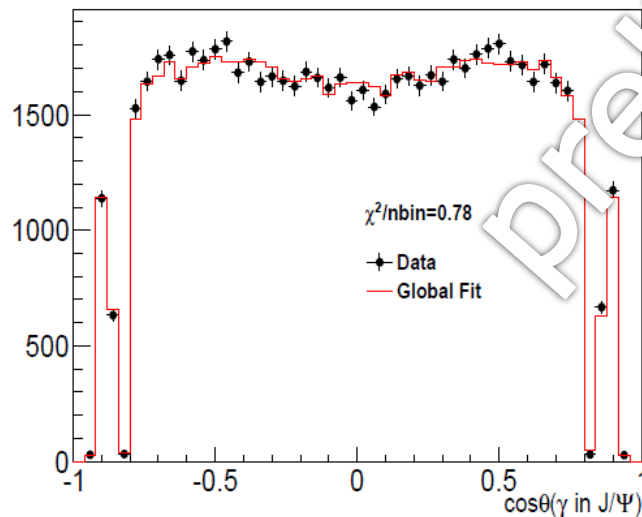
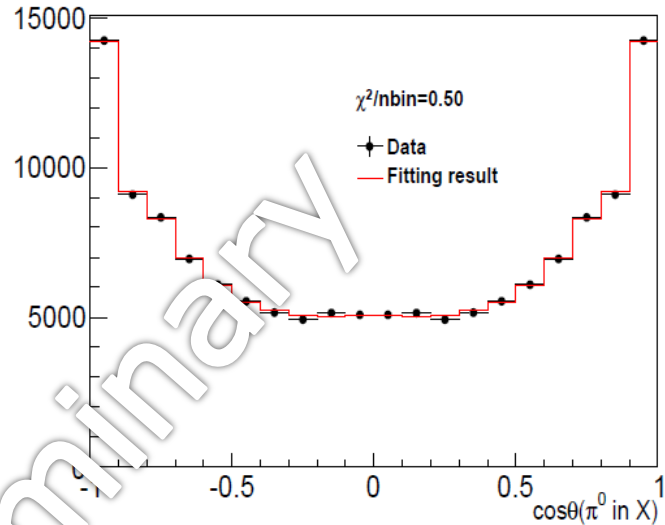
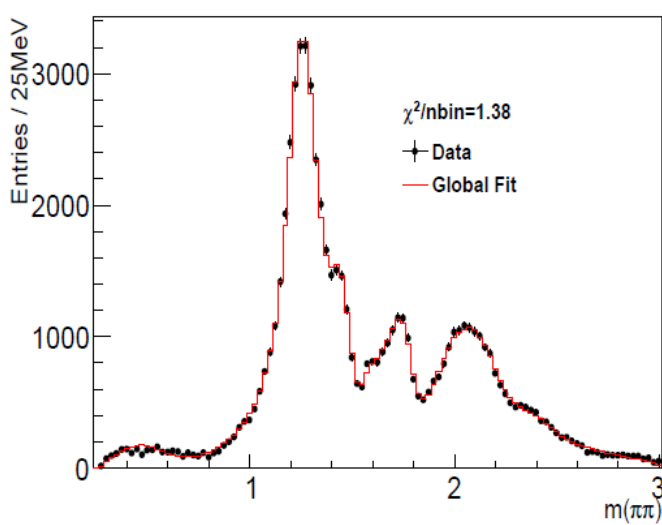

Powered by
GPUPWA
gpupwa.sourceforge.net

Preliminary PWA results of $J/\psi \rightarrow \gamma \pi^0 \pi^0$

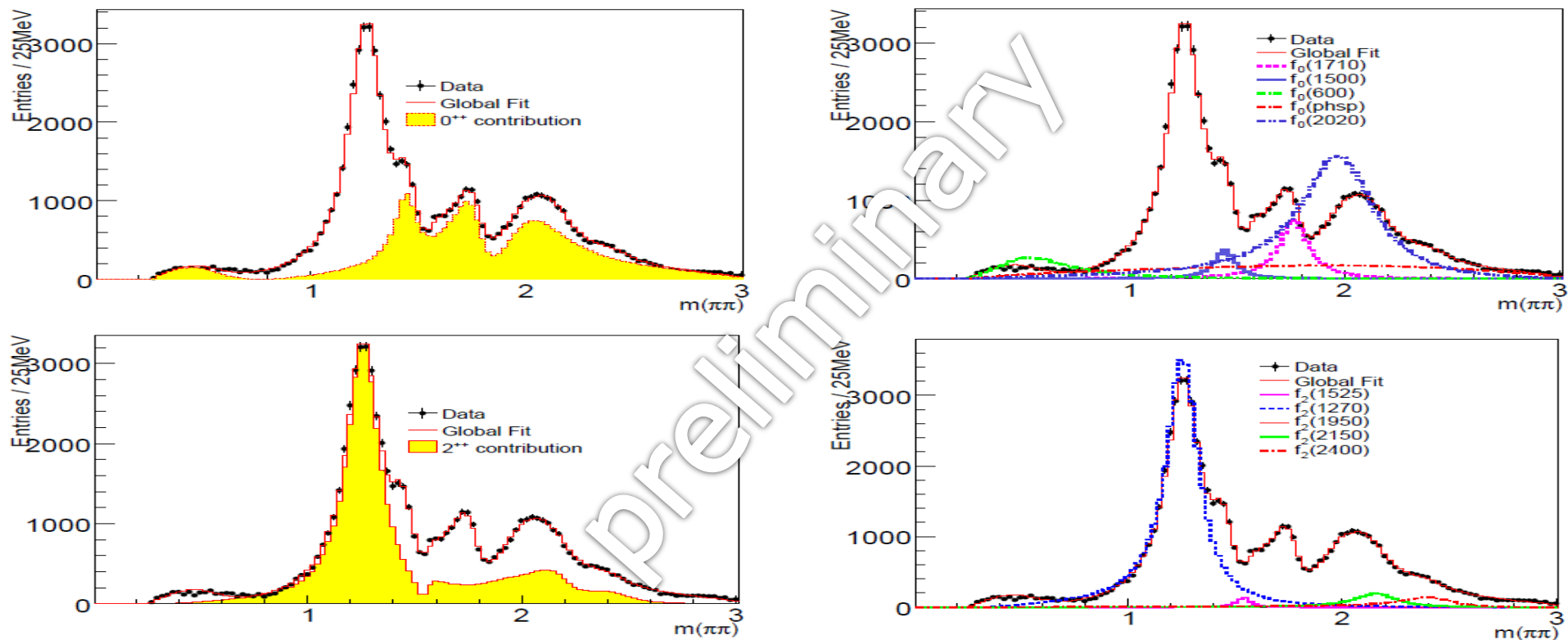

* The parameters of $f_0(600)$ are fixed to "The sigma pole in $J/\psi \rightarrow \omega \pi^+ \pi^-$ " PLB 598 149

** Non resonant component: 0^+ phsp

Preliminary PWA results of $J/\psi \rightarrow \gamma \pi^0 \pi^0$

Resonances	Mass(MeV/c ²)	Width(MeV/c ²)	$\mathcal{B}(J/\psi \rightarrow \gamma X \rightarrow \gamma \pi^0 \pi^0)$	Significance
$f_0(600)$	446	578	$0.91^{+0.02+0.32}_{-0.02-0.17} \times 10^{-4}$	$> 40\sigma$
$f_2(1270)$	1255^{+1+4}_{-1-1}	177^{+2+1}_{-2-6}	$5.77^{+0.03+0.42}_{-0.03-0.34} \times 10^{-4}$	$> 40\sigma$
$f_0(1500)$	1445^{+3+9}_{-3-30}	113^{+6+5}_{-6-11}	$0.44^{+0.01+0.05}_{-0.01-0.08} \times 10^{-4}$	27.6σ
$f_2'(1525)$	1539^{+5+5}_{-6-11}	72^{+10+6}_{-9-6}	$0.09^{+0.01+0.08}_{-0.01-0.01} \times 10^{-4}$	13.5σ
$f_0(1710)$	1765^{+3+3}_{-3-4}	159^{+7-3}_{-1-13}	$1.11^{+0.02+0.10}_{-0.02-0.19} \times 10^{-4}$	$> 40\sigma$
$f_2(1950)$	1901^{+22+51}_{-23-5}	313^{+8+65}_{-13-63}	$0.11^{+0.01+0.06}_{-0.01-0.05} \times 10^{-4}$	11.4σ
$f_0(2020)$	1971^{+6+24}_{-6-4}	409^{+14+9}_{-13-14}	$5.31^{+0.04+0.38}_{-0.04-0.44} \times 10^{-4}$	35.6σ
$f_2(2150)$	2160^{+13+7}_{-13-11}	227^{+22+3}_{-21-31}	$0.32^{+0.02+0.10}_{-0.02-0.08} \times 10^{-4}$	14.2σ
$f_2(2340)$	2419^{+13+7}_{-13-16}	286^{+28+10}_{-26-37}	$0.28^{+0.01+0.04}_{-0.01-0.05} \times 10^{-4}$	17.8σ

* the changes in log likelihood value and in the number of free parameters in the fit with or without a resonance are used as a measure of the significance of the resonance

** the statistical errors are determined by $\Delta \ln L = 0.5$

“Model independent” PWA

1, Bin-by-bin fit:

Decompose the angular distributions in each mass bin

2, MIPWA in Dalitz Plot Analysis:

Using interference to fix the S-wave (parameterize S-wave as a complex spline)

EG1: $J/\psi \rightarrow \gamma 4\pi$ @ BES I,
Phys. Letts. B473 (2000) 207

EG2 : $D \rightarrow K\pi\pi$ @ E791,
Phys. Rev. D73 (2006) 023004

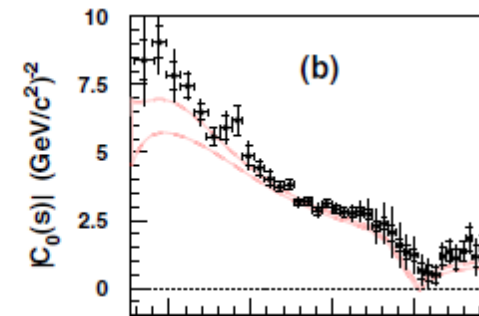
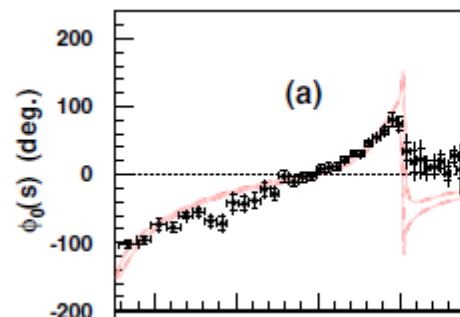
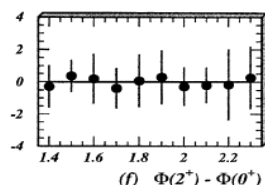
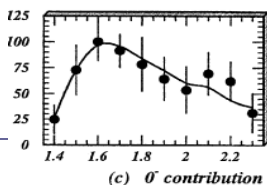
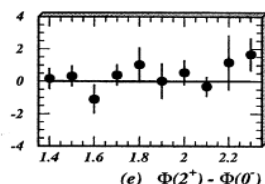
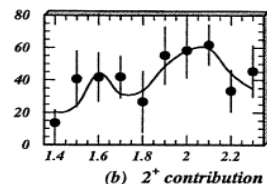
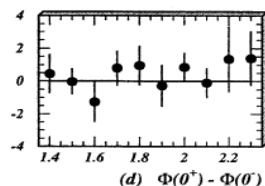
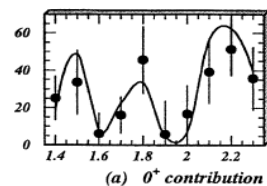

Tests of model independent PWA methods

MC sample: $J/\psi \rightarrow \gamma \pi^0 \pi^0$ ($\sim 5\% \omega_{\gamma \pi^0 \pi^0}$)

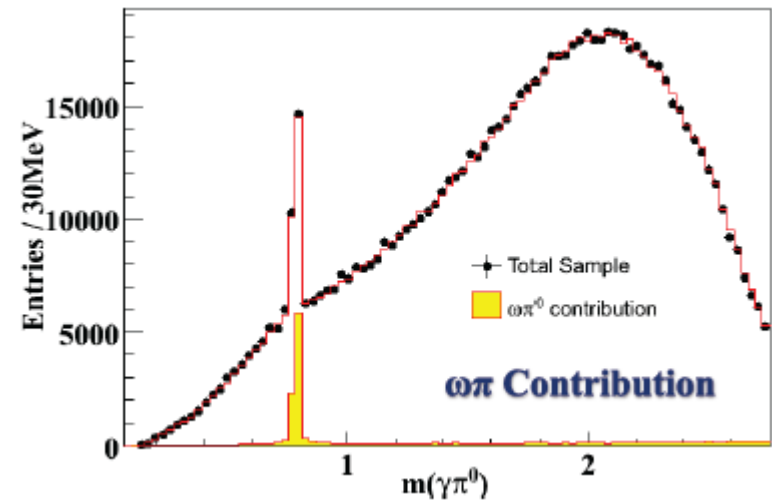
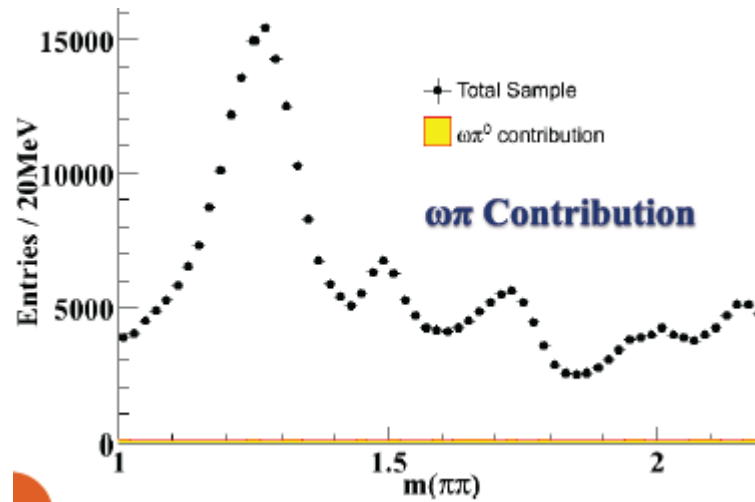
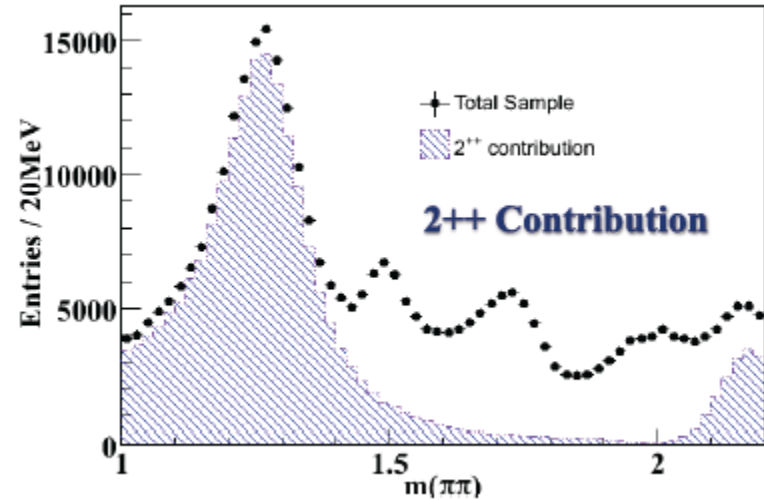
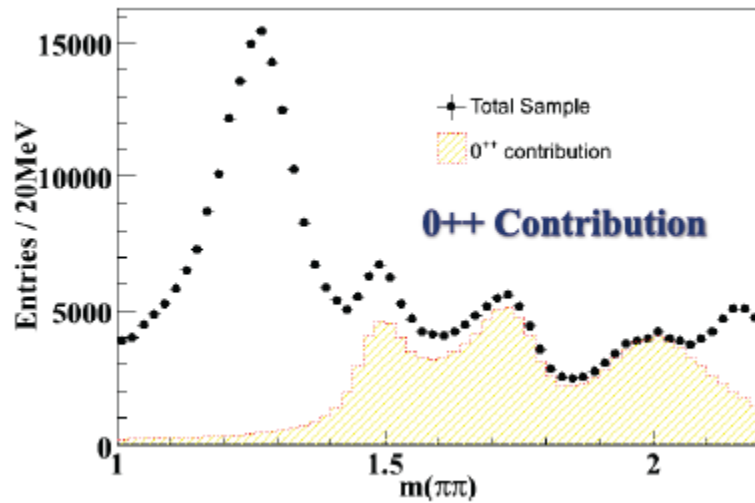

Tests of model independent PWA methods: failed cases: fitting results cannot reproduce inputs

bin-by-bin fit

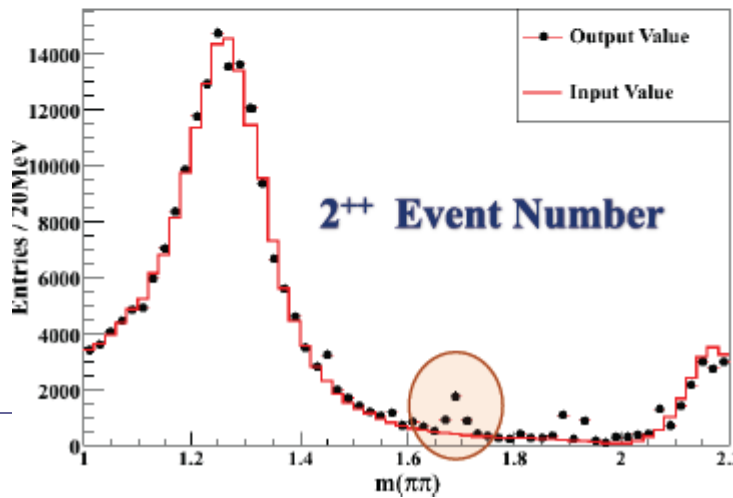
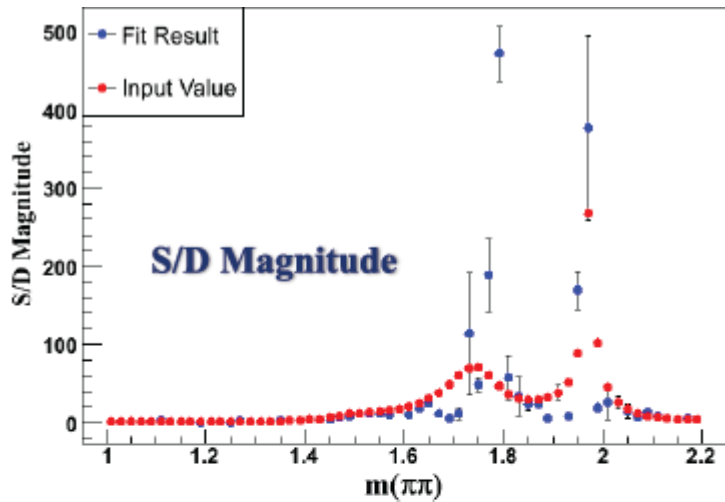

MIPWA fit

0^{++} Event Number

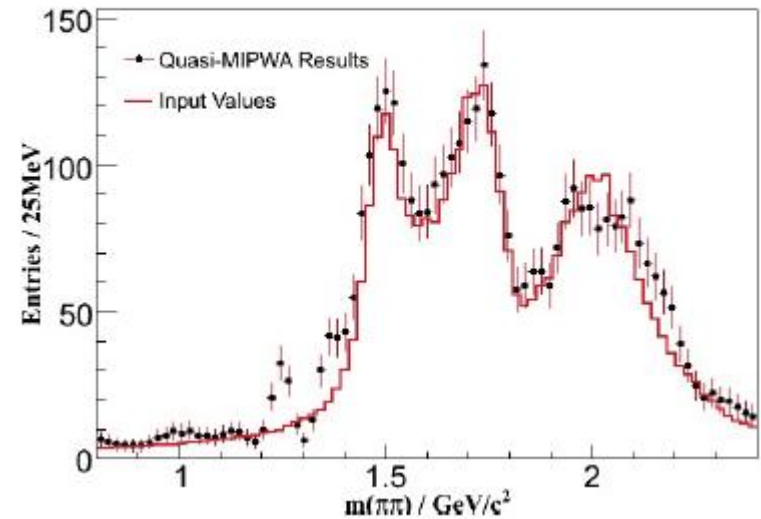

Tests of model independent PWA methods

There're multi solutions

Likelihood profile of one bin in a failed bin-by-bin fit

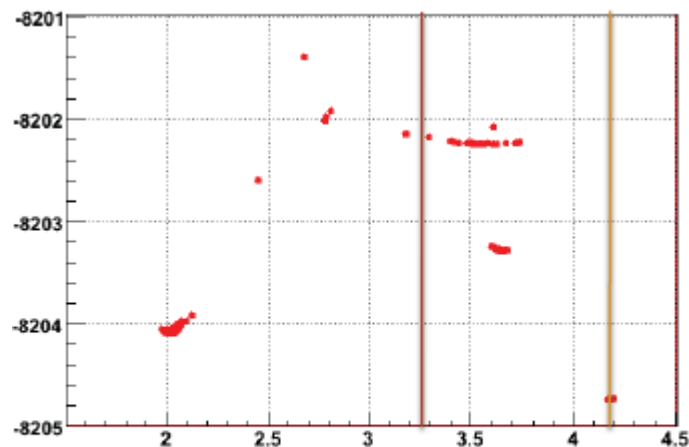

S-D phase @ 1.66~1.68GeV Bin
Input : 3.26 Output : 4.18

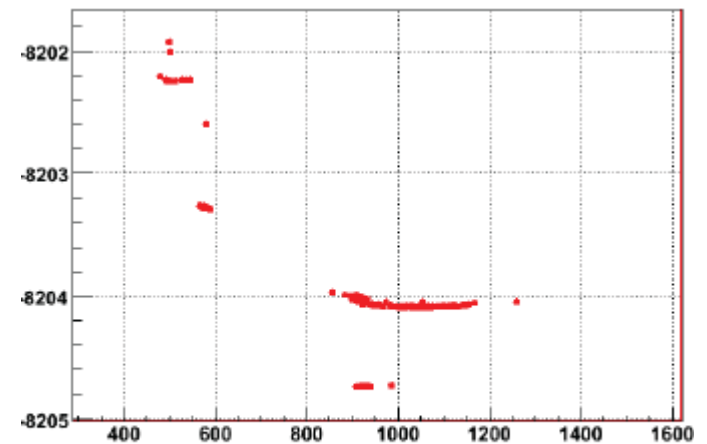

2++ Number @ 1.66~1.68GeV Bin
Input : 417 Output : 929

Some of the solutions provide even better likelihoods than input

Not a summary

Model independent PWA has the attractive advantage.

However, there're "multi solution" problems. (\sim Barrelet zeros in 2-body scattering)

- How to find all the solutions**
- How to choose the right one**

MIPWA might NOT always provide the correct solution. Nevertheless, it can be employed as a good check whether the model is a good fit to data.

To precisely extract the physics, more efforts are needed. (IHEP group and Indiana group are working on this in BES.)

Outlook

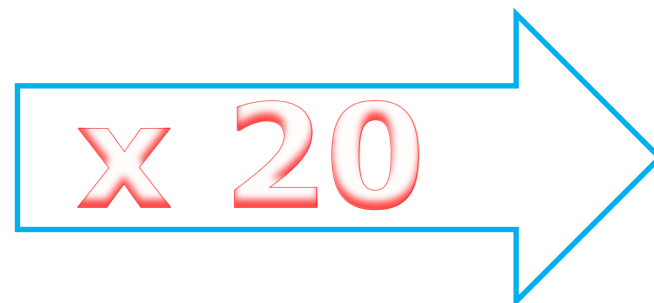
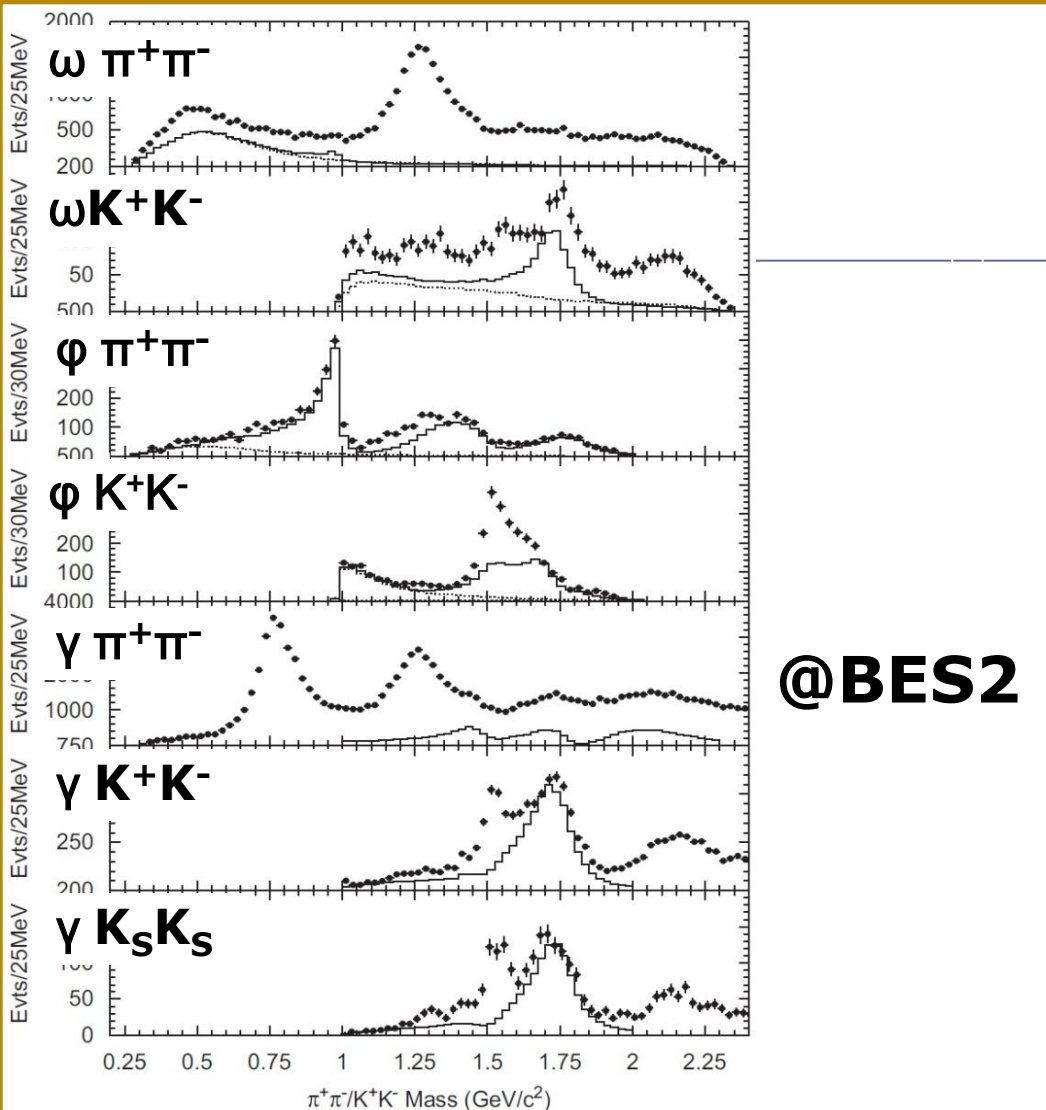

+
 $\eta(\prime)\eta(\prime)$
...

Thank you

Backup

PWA amplitudes

covariant tensor formalism, Zou & Bugg, Eur.Phys.J. A16 537

$$A = \psi_\mu(m_1)e_\nu^*(m_2)A^{\mu\nu} = \psi_\mu(m_1)e_\nu^*(m_2) \sum_i \Lambda_i U_i^{\mu\nu}.$$

$\psi_\mu(m)$ polarization of ψ

$e_\nu(m)$ polarization of γ

Λ coupling strength (complex)

$$\begin{aligned} \frac{d\sigma}{d\Phi_n} &= \frac{1}{2} \sum_{m_1=1}^2 \sum_{m_2=1}^2 \psi_\mu(m_1)e_\nu^*(m_2)A^{\mu\nu}\psi_{\mu'}^*(m_1)e_{\nu'}(m_2)A^{*\mu'\nu'} \\ &= -\frac{1}{2} \sum_{m_1=1}^2 \psi_\mu(m_1)\psi_{\mu'}^*(m_1)g_{\nu\nu'}^{(\perp\perp)}A^{\mu\nu}A^{*\mu'\nu'} \\ &= -\frac{1}{2} \sum_{\mu=1}^2 A_{\mu\nu}g_{\nu\nu'}^{(\perp\perp)}A^{*\mu\nu'} \\ &= -\frac{1}{2} \sum_{i,j} \Lambda_i \Lambda_j^* \sum_{\mu=1}^2 U_i^{\mu\nu} g_{\nu\nu'}^{(\perp\perp)} U_j^{*\mu\nu'} \equiv \sum_{i,j} P_{ij} \cdot F_{ij}, \\ P_{ij} &= P_{ji}^* = \Lambda_i \Lambda_j^*, \\ F_{ij} &= F_{ji}^* = -\frac{1}{2} \sum_{\mu=1}^2 U_i^{\mu\nu} g_{\nu\nu'}^{(\perp\perp)} U_j^{*\mu\nu'}. \end{aligned}$$

Partial wave amplitudes

$$U_{\gamma f_0}^{\mu\nu} = g^{\mu\nu} f(f_0)$$

$$U_{(\gamma f_2)1}^{\mu\nu} = \tilde{t}^{(f_2)\mu\nu} f(f_2),$$

$$U_{(\gamma f_2)2}^{\mu\nu} = g^{\mu\nu} p_\psi^\alpha p_\psi^\beta \tilde{t}_{\alpha\beta}^{(f_2)} B_2(Q_{\Psi\gamma f_2}) f(f_2),$$

$$U_{(\gamma f_2)3}^{\mu\nu} = q^\mu \tilde{t}_\alpha^{(f_2)\nu} p_\psi^\alpha B_2(Q_{\psi\gamma f_2}) f(f_2),$$

$$U_{(\gamma f_4)1}^{\mu\nu} = \tilde{t}_{\alpha\beta}^{(f_4)\mu\nu} p_\psi^\alpha p_\psi^\beta B_2(Q_{\Psi\gamma f_4}) f(f_4),$$

$$U_{(\gamma f_4)2}^{\mu\nu} = g^{\mu\nu} \tilde{t}_{\alpha\beta\gamma\delta}^{(f_4)} p_\psi^\alpha p_\psi^\beta p_\psi^\gamma p_\psi^\delta B_4(Q_{\psi\gamma f_4}) f(f_4),$$

$$U_{(\gamma f_4)3}^{\mu\nu} = q^\mu \tilde{t}_{\alpha\beta\gamma}^{(f_4)\nu} p_\psi^\alpha p_\psi^\beta p_\psi^\gamma B_4(Q_{\Psi\gamma f_4}) f(f_4),$$

t: orbital tensors

B: barrier factors

f: BW

Likelihood calculation

Likelihood, given n data points at Ω_i

$$\mathcal{L} \propto \prod_{i=1}^n \frac{I(\Omega_i)}{\int \eta(\Omega) I(\Omega) d\Omega}$$

Product over data events

Detection efficiency

Normalisation integral over phase space

Log likelihood

$$\log \mathcal{L} \propto \sum_{i=1}^n \log \left(\sum_{\alpha, \alpha'} V_{\alpha} V_{\alpha'}^* \overbrace{A_{\alpha}(\Omega_i) A_{\alpha'}^*(\Omega_i)}^{\text{Independent of fit parameters: precalculate; memory } \mathcal{O}(N_{\text{event}} \times N_{\text{wave}}^2)} \right) - \sum_{\alpha, \alpha'} \log \left(V_{\alpha} V_{\alpha'}^* \overbrace{\left(\frac{1}{N_{\text{MC}}^{\text{gen}}} \sum_{i=1}^{N_{\text{MC}}^{\text{rec}}} A_{\alpha}(\Omega_i) A_{\alpha'}^*(\Omega_i) \right)}^{\text{Independent of fit parameters: precalculate}} \right)$$

Sum over data events

Sum over partial waves

Computationally intensive: $\mathcal{O}(N_{\text{iteration}} \times N_{\text{event}} \times N_{\text{wave}}^2)$

Normalisation integral as a sum over MC events
Summing only reconstructed events takes into account detection efficiency

GPUPWA

N. Berger, B.J. Liu and J.K. Wang, J.Phys.Conf.Ser., 219, 042031



OpenCL

