

## AGENDA

- |   |                             |
|---|-----------------------------|
| <b>1) General Status of DISCORAP activities</b>                     | <i>P.Fabbricatore</i>       |
| <b>2) Cold mass 2D and 3D drawings and ASG activities</b>           | <i>P.Fabbricatore</i>       |
| <b>3) 2D Cross section- Mechanics and magnetics problematic</b>     | <i>S.Farinon</i>            |
| <b>4) End coil- Field and losses.</b>                               | <i>M.Sorbi</i>              |
| <b>5) Conductor Development status</b>                              | <i>G.Volpini</i>            |
| <b>6) Limits of INFN procurement.</b>                               | <i>P.Fabbricatore</i>       |
| <b>7) Magnetic measurements of collared coil.</b>                   |                             |
| <b>8) Magnet cooling and recooling</b>                              | <b>M.Kuaschke, Y.Xiang</b>  |
| <b>9) R&amp;D topics (heat transfer, MQE, Quenchpropagation,..)</b> | <b>J.Kaugerts, E. Floch</b> |

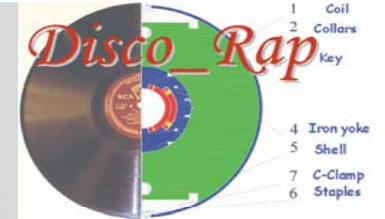

## GENERAL STATUS OF DISCORAP ACTIVITIES

P.Fabbricatore

- 1) General planning
- 2) Model construction
- 3) Design and Engineering
- 4) Next step: the construction of prototype cold mass

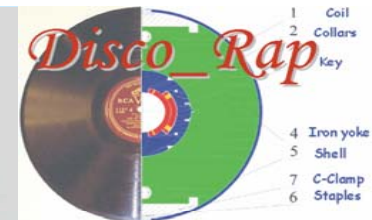

## MASTER PLAN OF THE ACTIVITIES

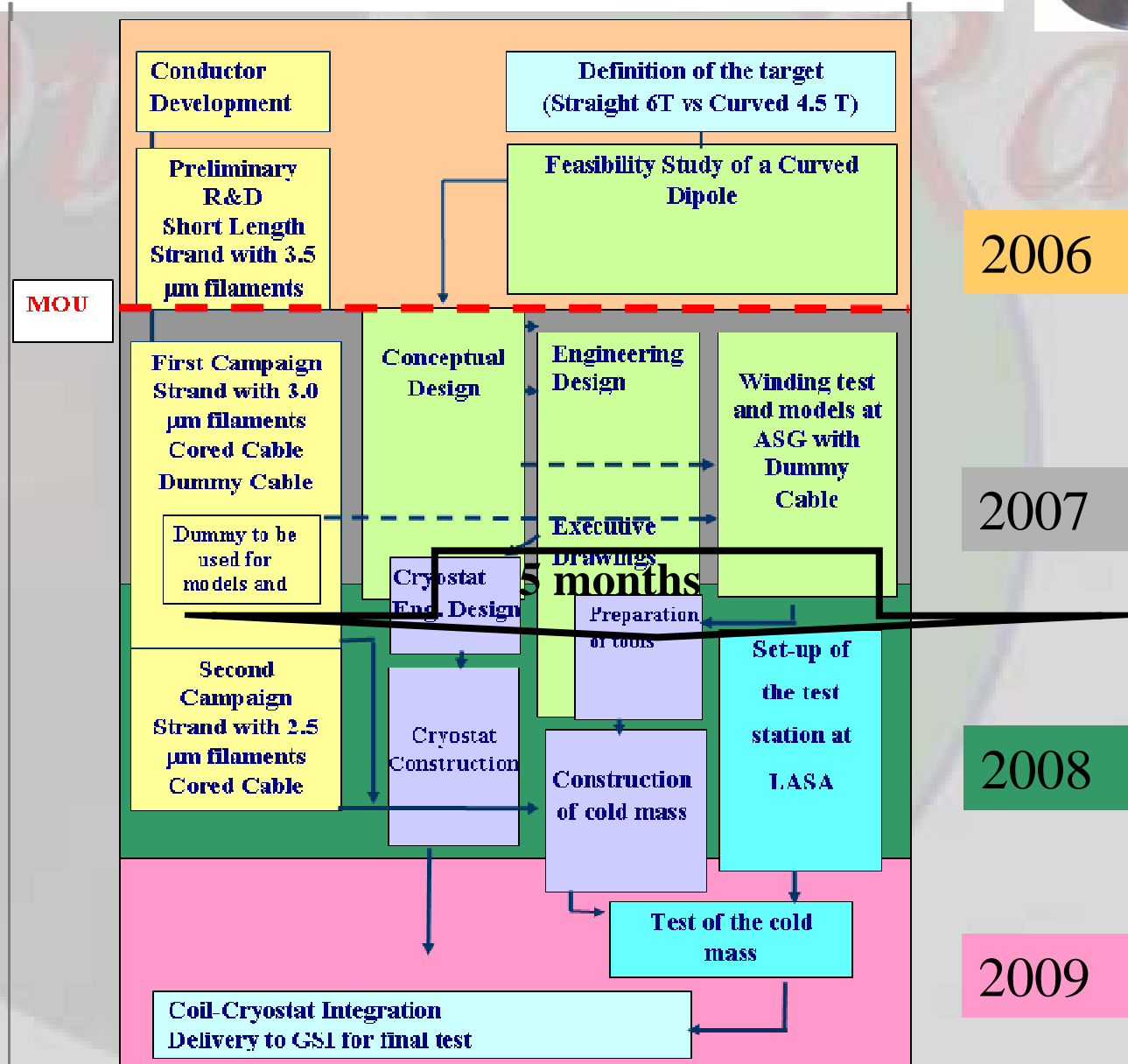

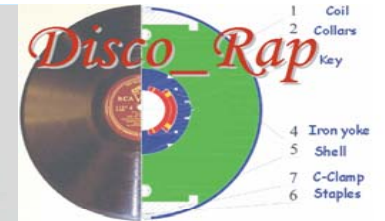

## Construction of the winding models – Revised schedule

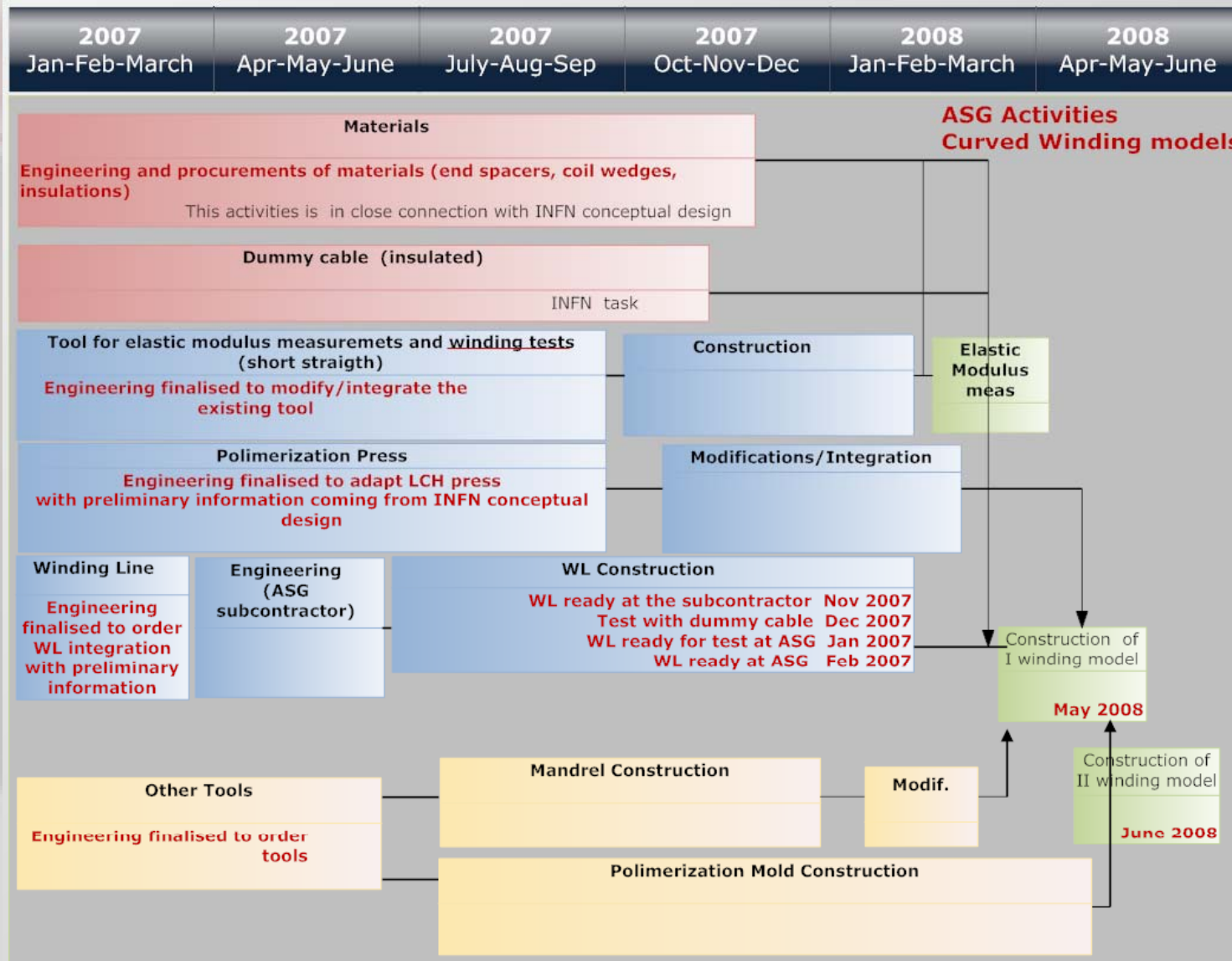

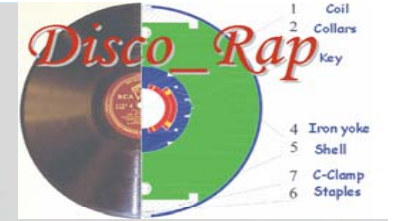

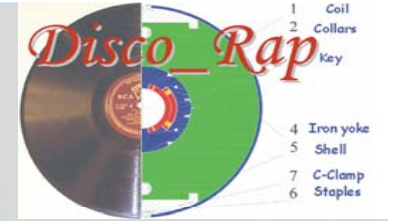

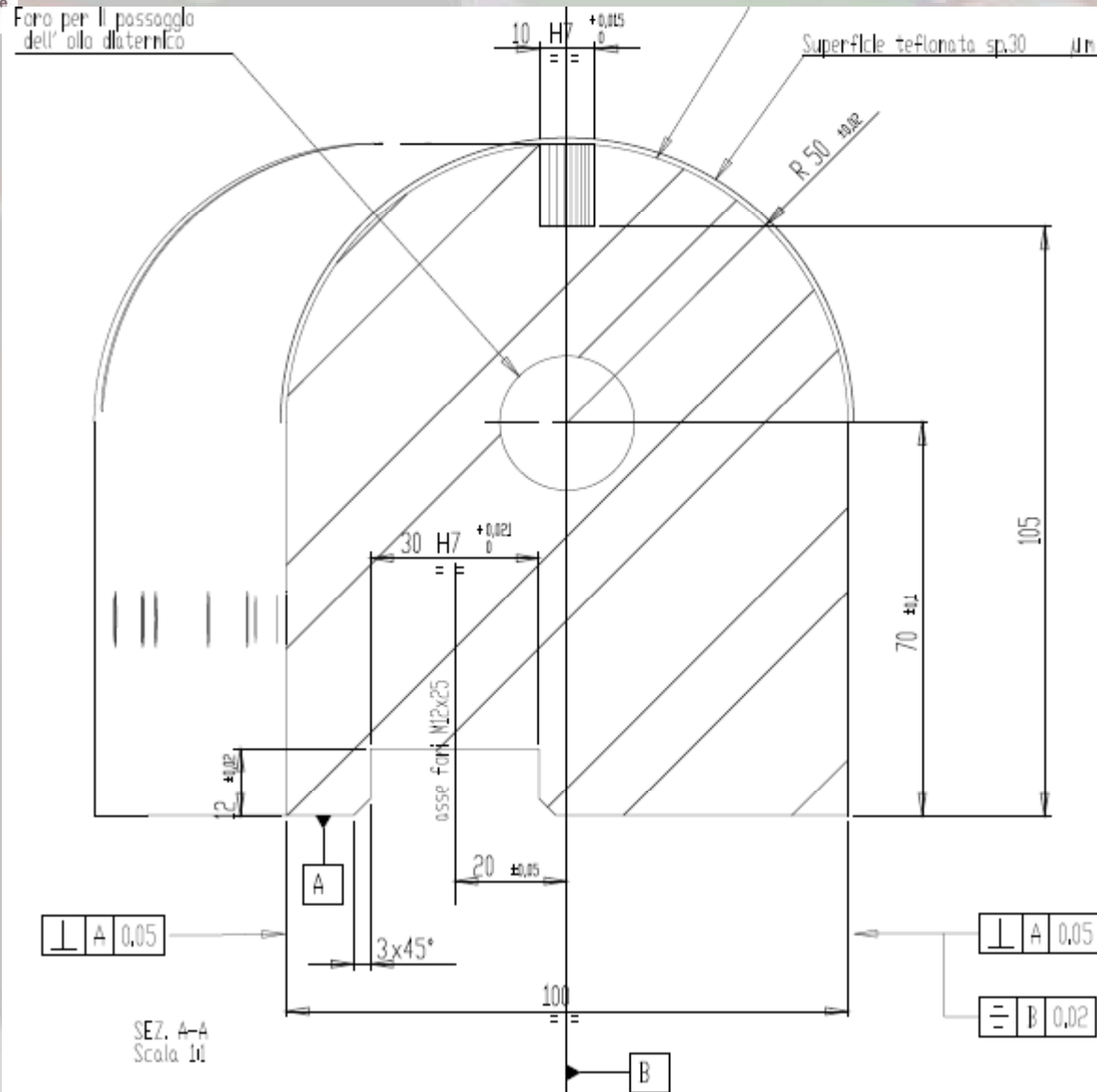
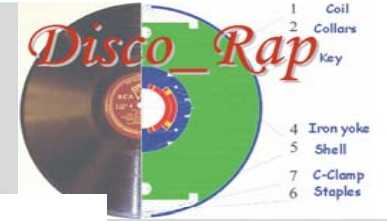

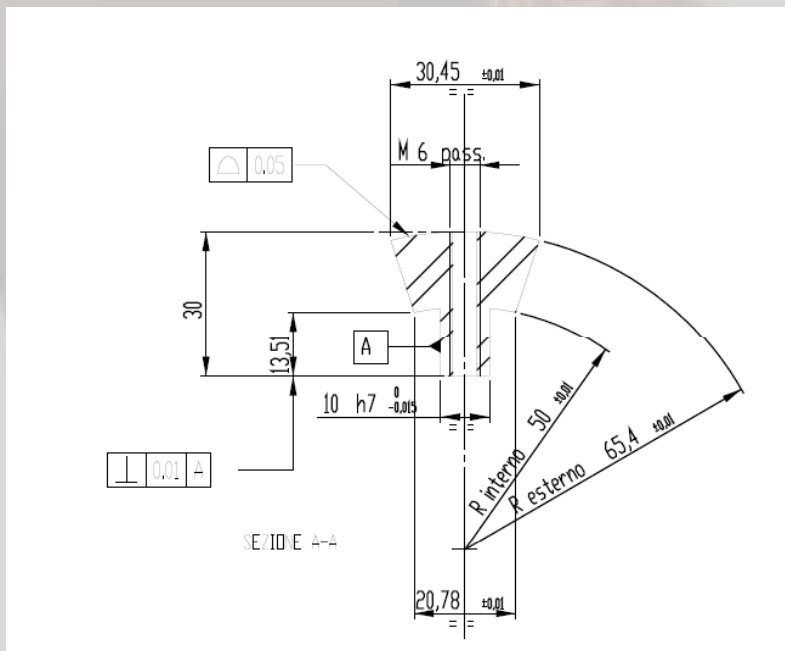
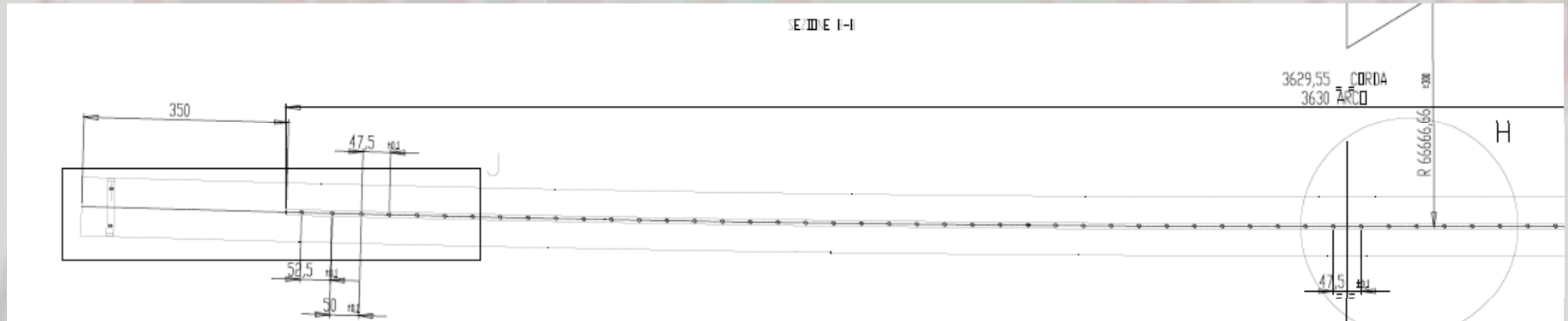
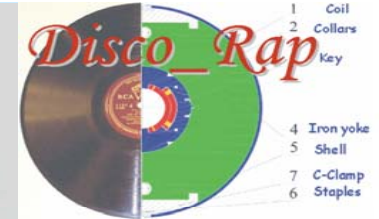

Some problems were met by ASG sub-provider for fulfilling the required tolerances of the curved mandrel, done through wire spark erosion + machining



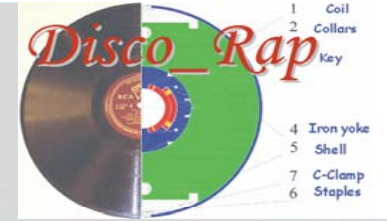

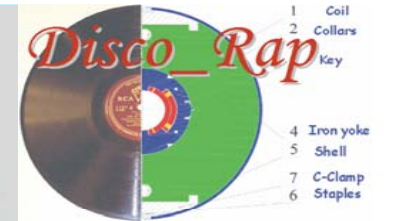

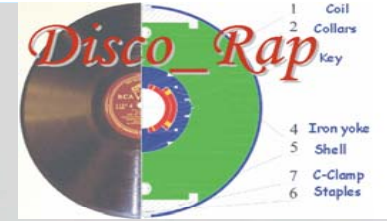

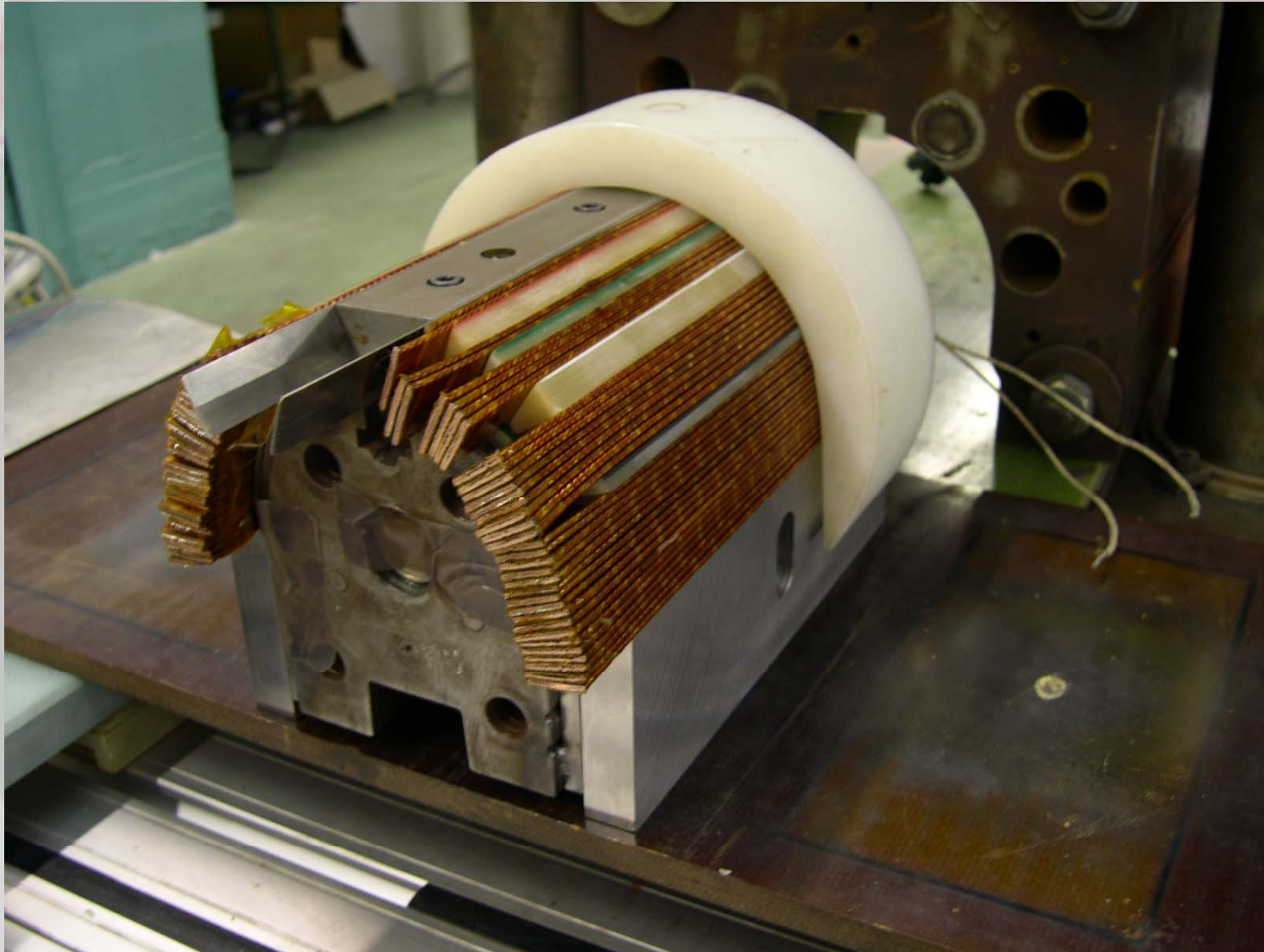
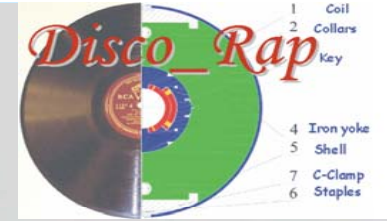

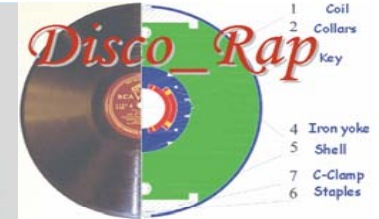

# Conceptual Design and Engineering

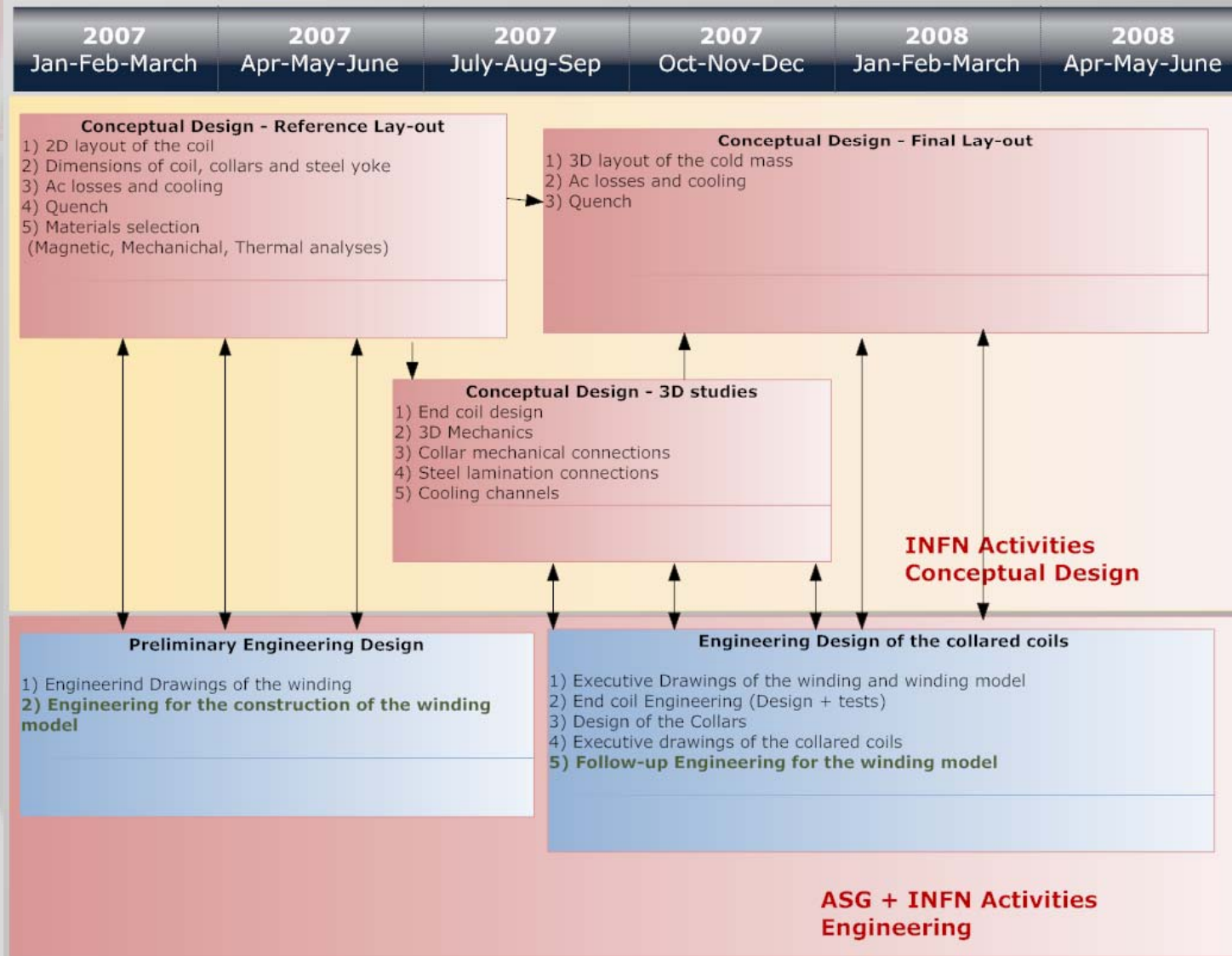

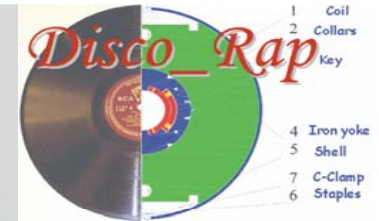

## Next contract for cold mass construction

Time (months)	Milestones
T0	Contract award date.
T0+1	End of engineering design of general equipments for the construction of the prototype
T0+1	End of engineering design of specific tooling for the construction of the prototype
T0+1	End of engineering design of the prototype . Start of material procurement
T0+6	Materials and tooling for winding and curing ready. Winding tests with dummy conductor
T0+7	Conductor ready. Start of winding
T0+8	End of winding
T0+8.5	End of curing
T0+9	Materials and tooling for cold mass completion
T0+10	End of collaring
T0+11	End of integration in the iron lamination
T0+12	End of the integration in the cryogenic vessel.

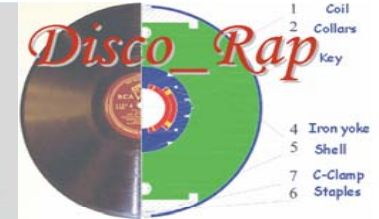

## Cold mass 2D and 3D drawings and ASG activities

P.Fabbricatore

### Warning:

The following drawings reflect the ideas of a in-progress design. The cross section is not yet frozen!  
Important freezing the cooling hole in the iron lamination. However many solutions will be retained for the final design

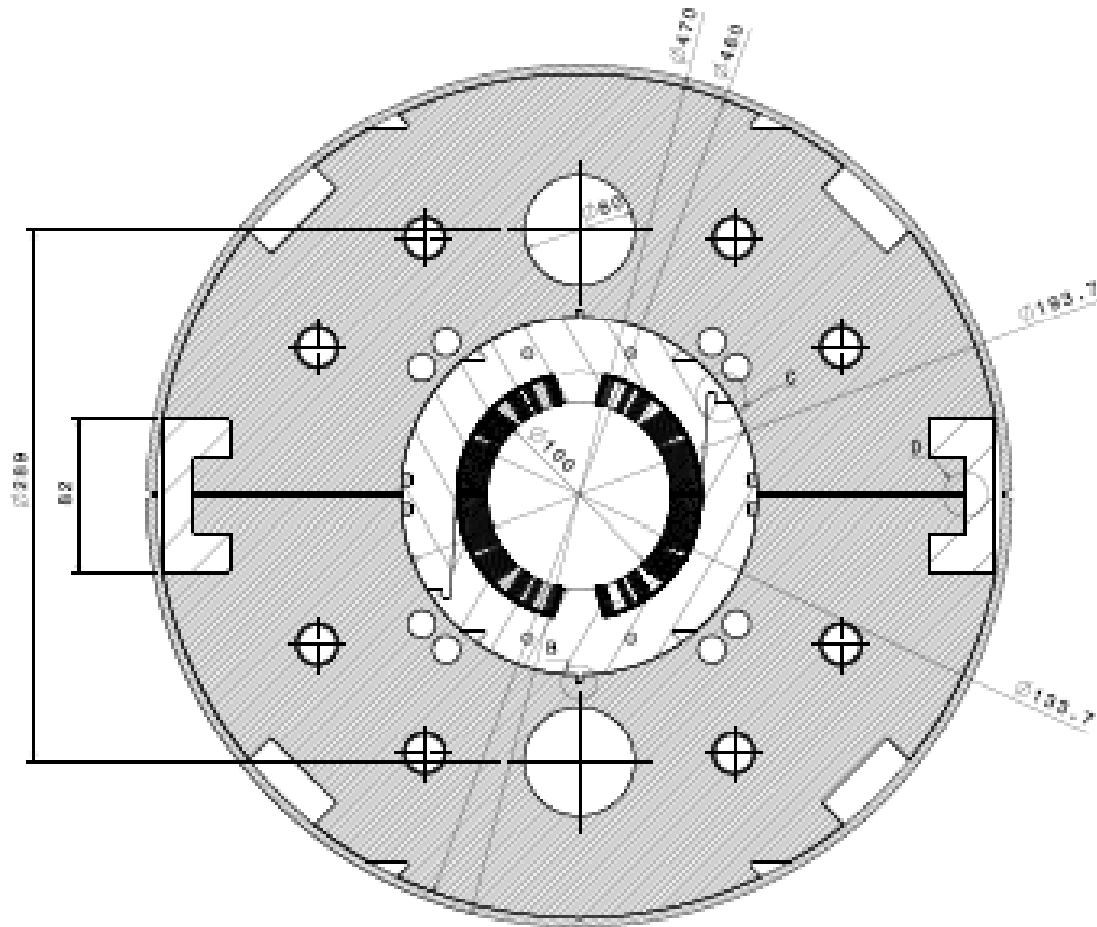
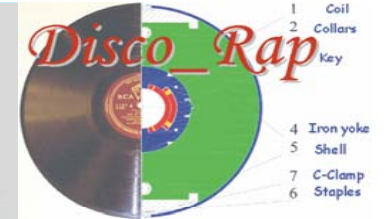

Scale: 1:2



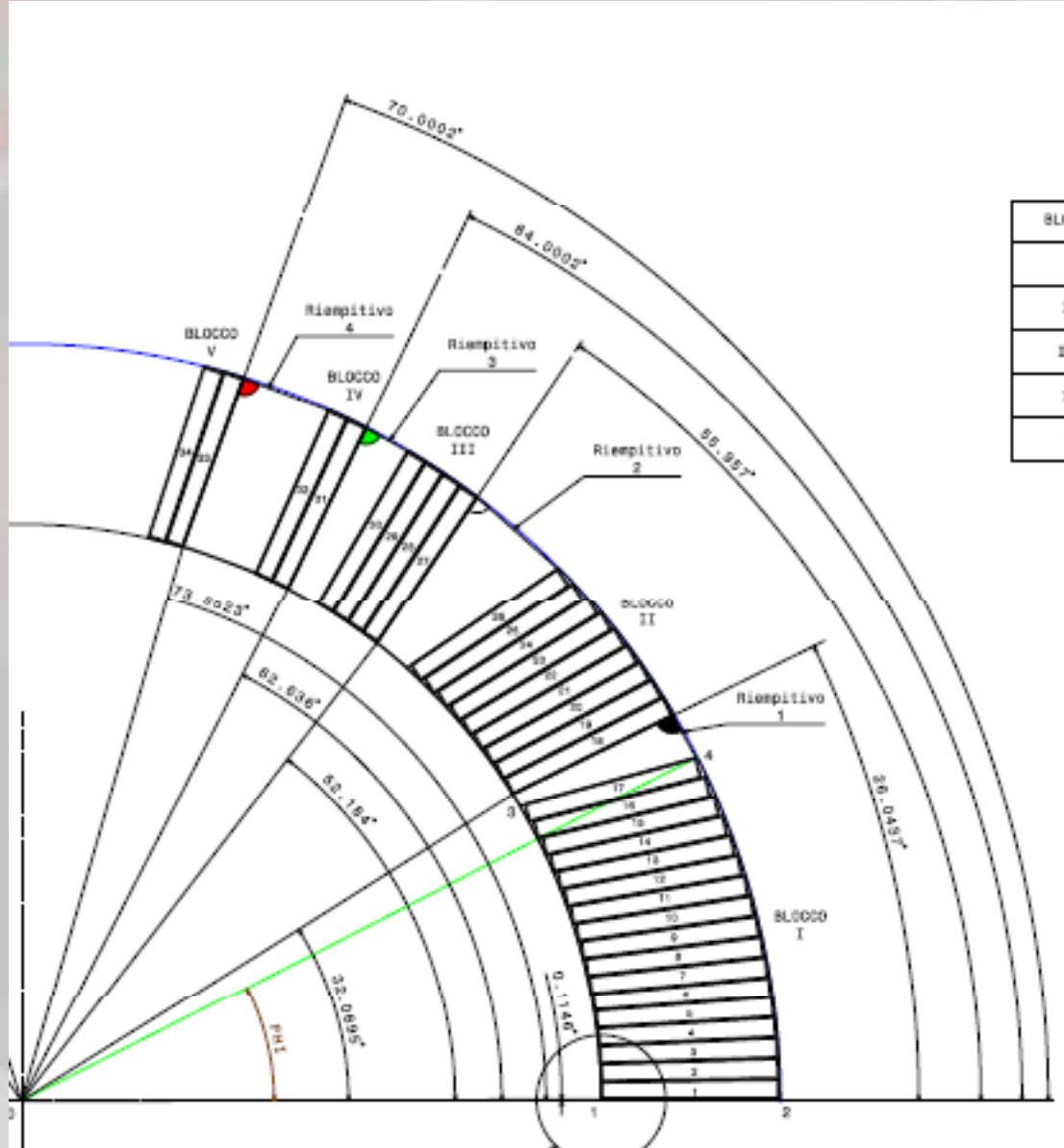
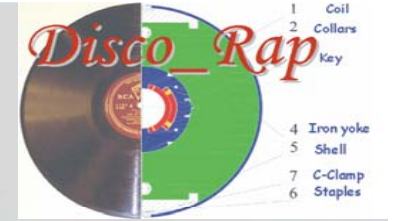

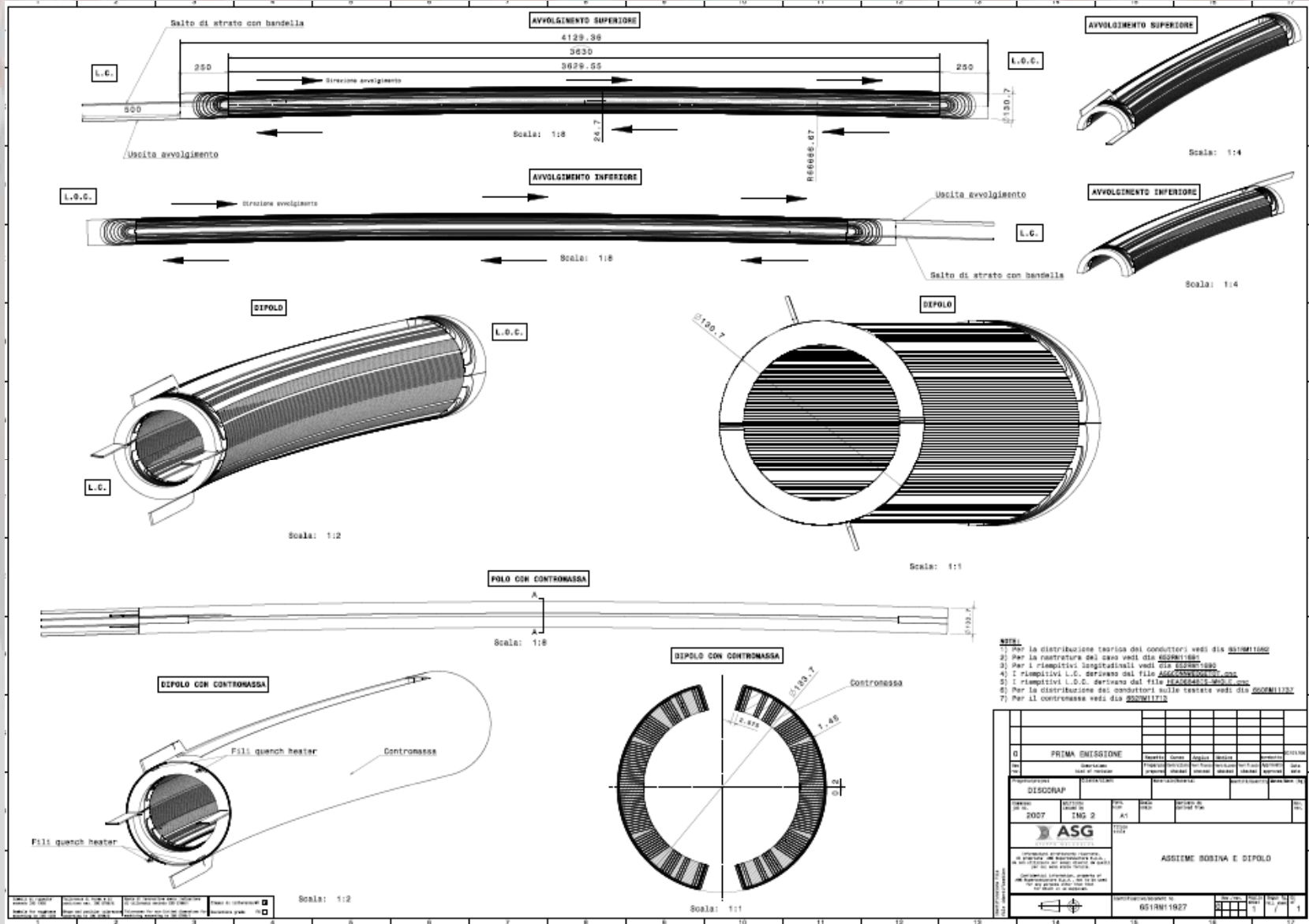
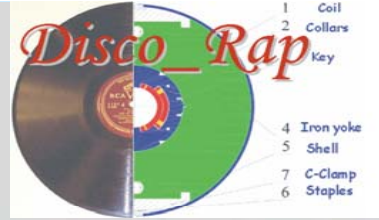

<b>PRIMA EMISSIONE</b>											
DISCORAP											
ASG											
ASSEMBLATO DA: G. B. G. M. G.											
VERIFICATO DA: G. B. G. M. G.											
CONTRAMASSA											
6514M1927											

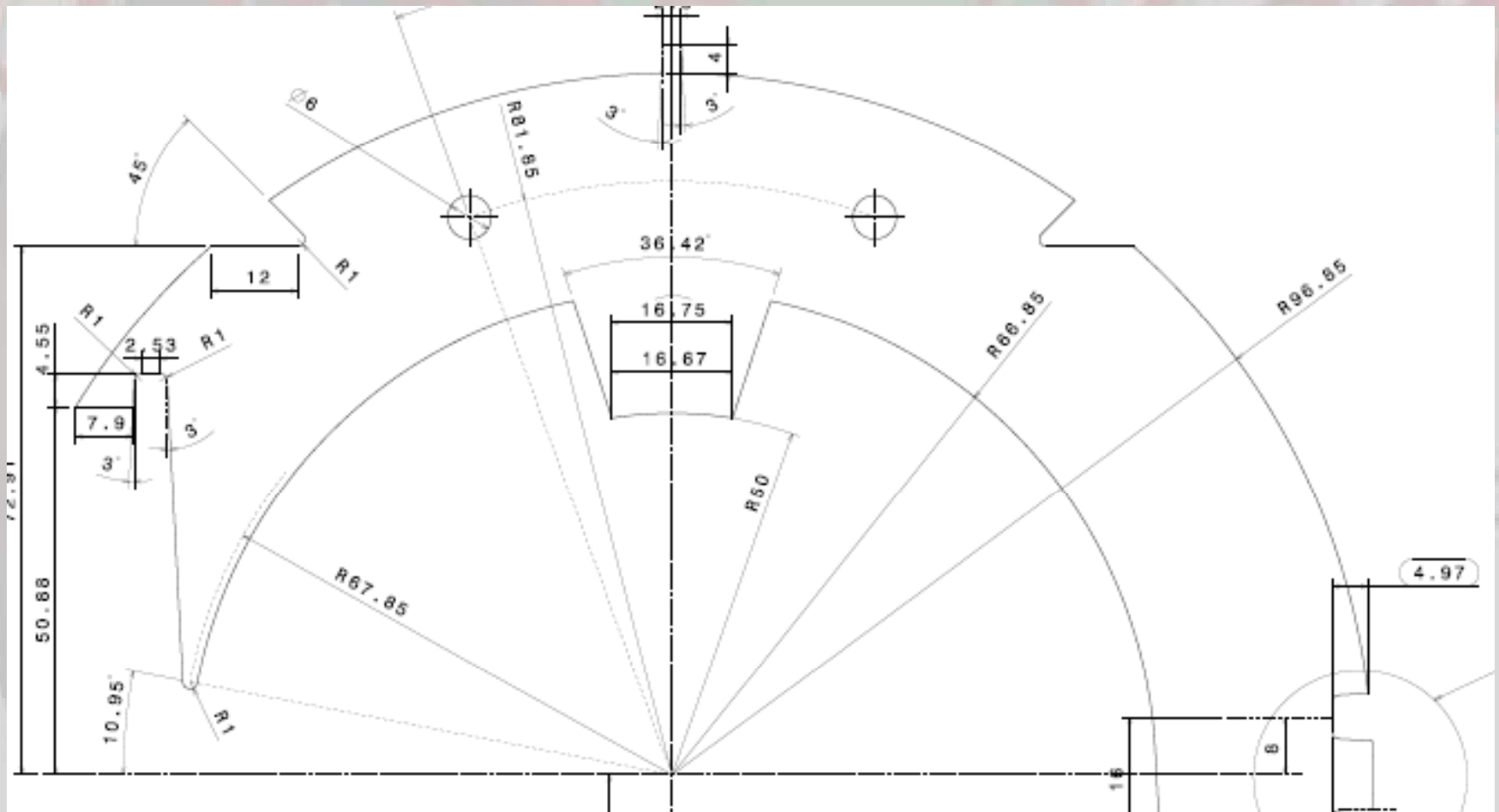
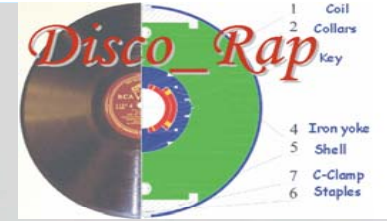

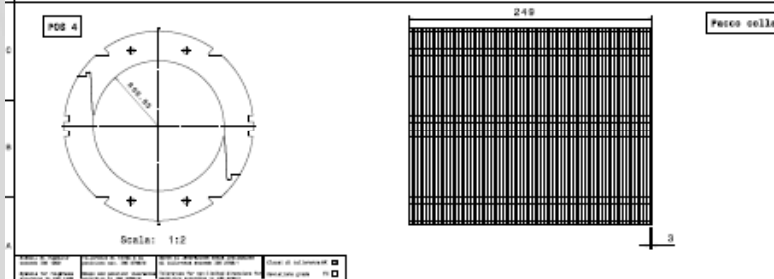
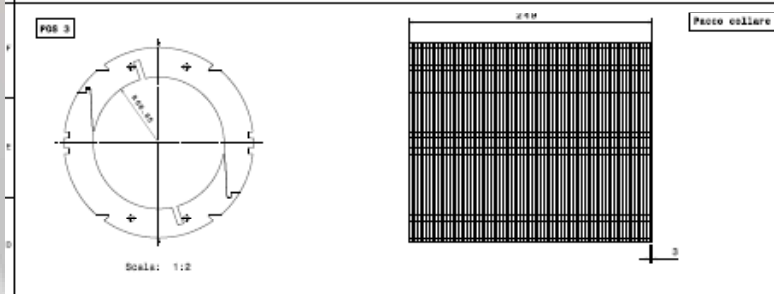
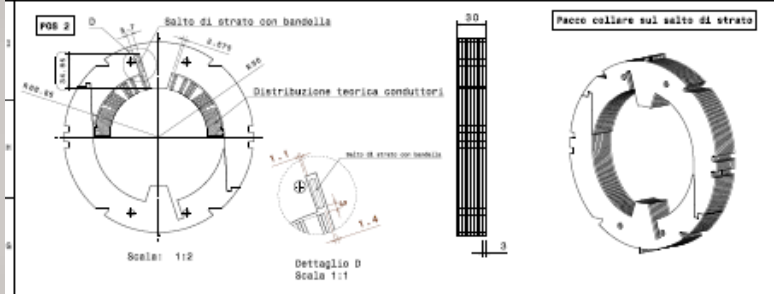
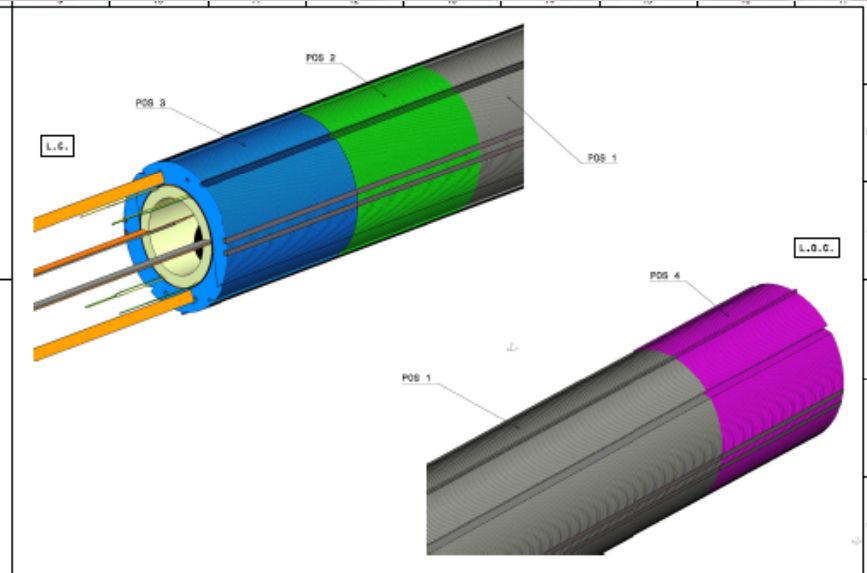
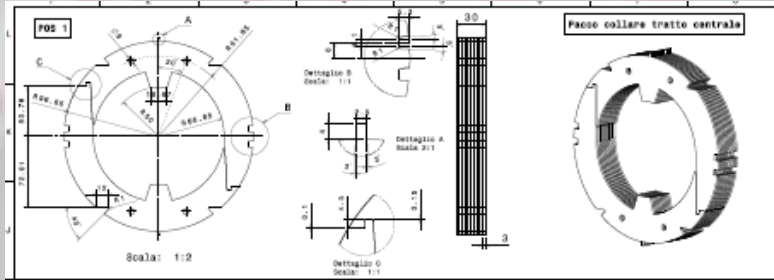
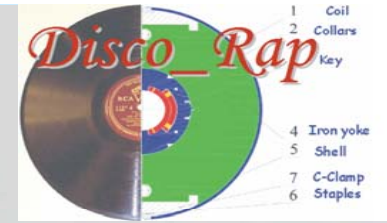

QTY	DESCRIPTION	REFERENCE	REVISION	DATE
1	PRIMA EMISSIONE			2007

DISCORAP	NOTIFICAZIONE	1	507
----------	---------------	---	-----

  

ASG	ASG	ASG
-----	-----	-----

  

6718M1926			
-----------	--	--	--

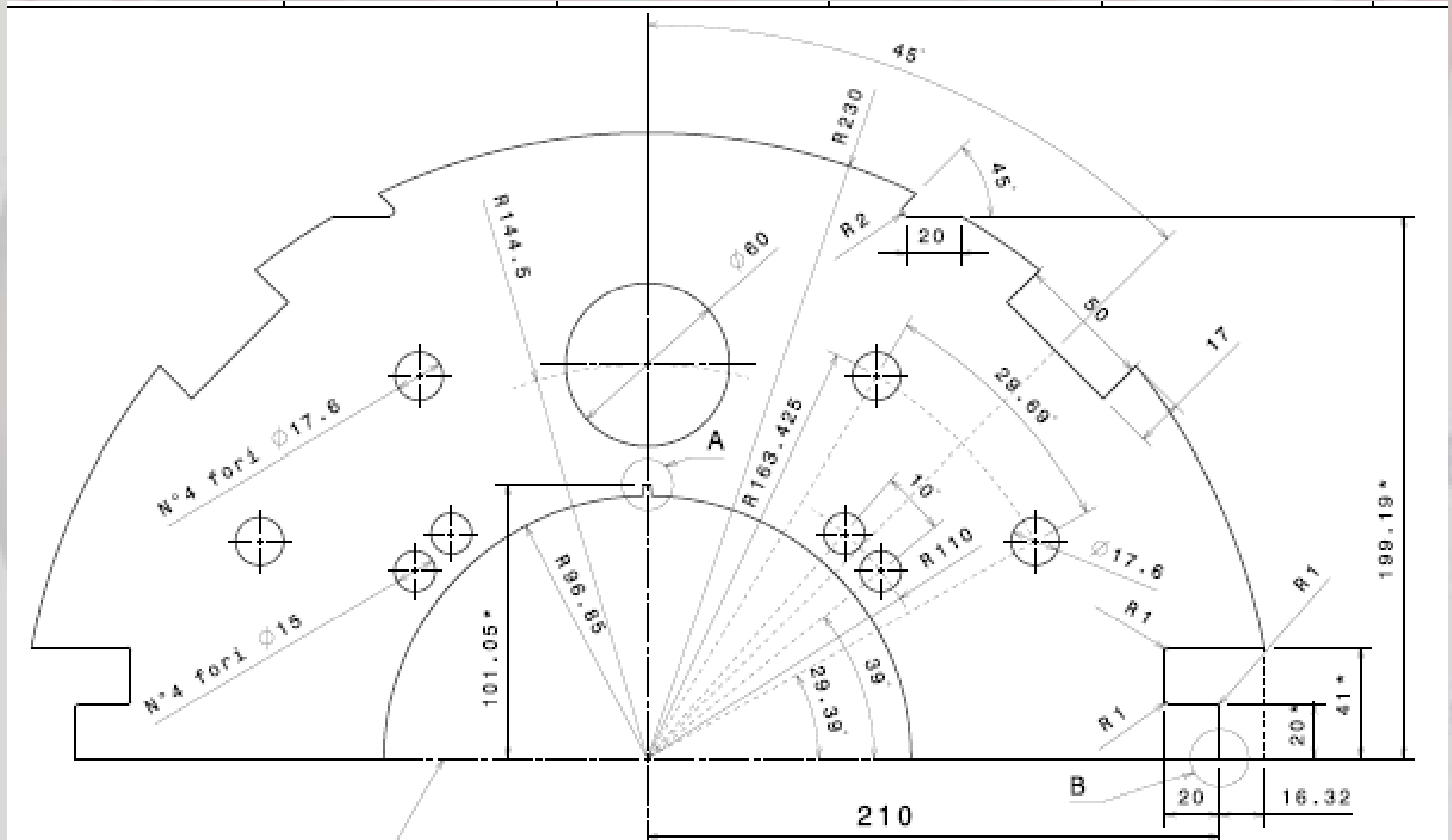
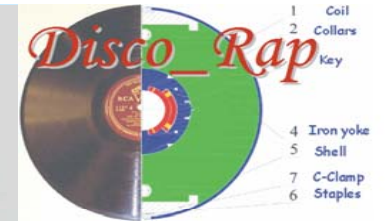

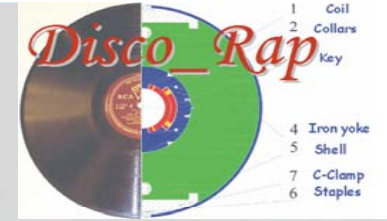

Pacco avvolgige curvato formato da lamierini ap 1 mm ad eccezione dei lamierini di testa ap 5-6 mm per permettere la avanzatura del tubo

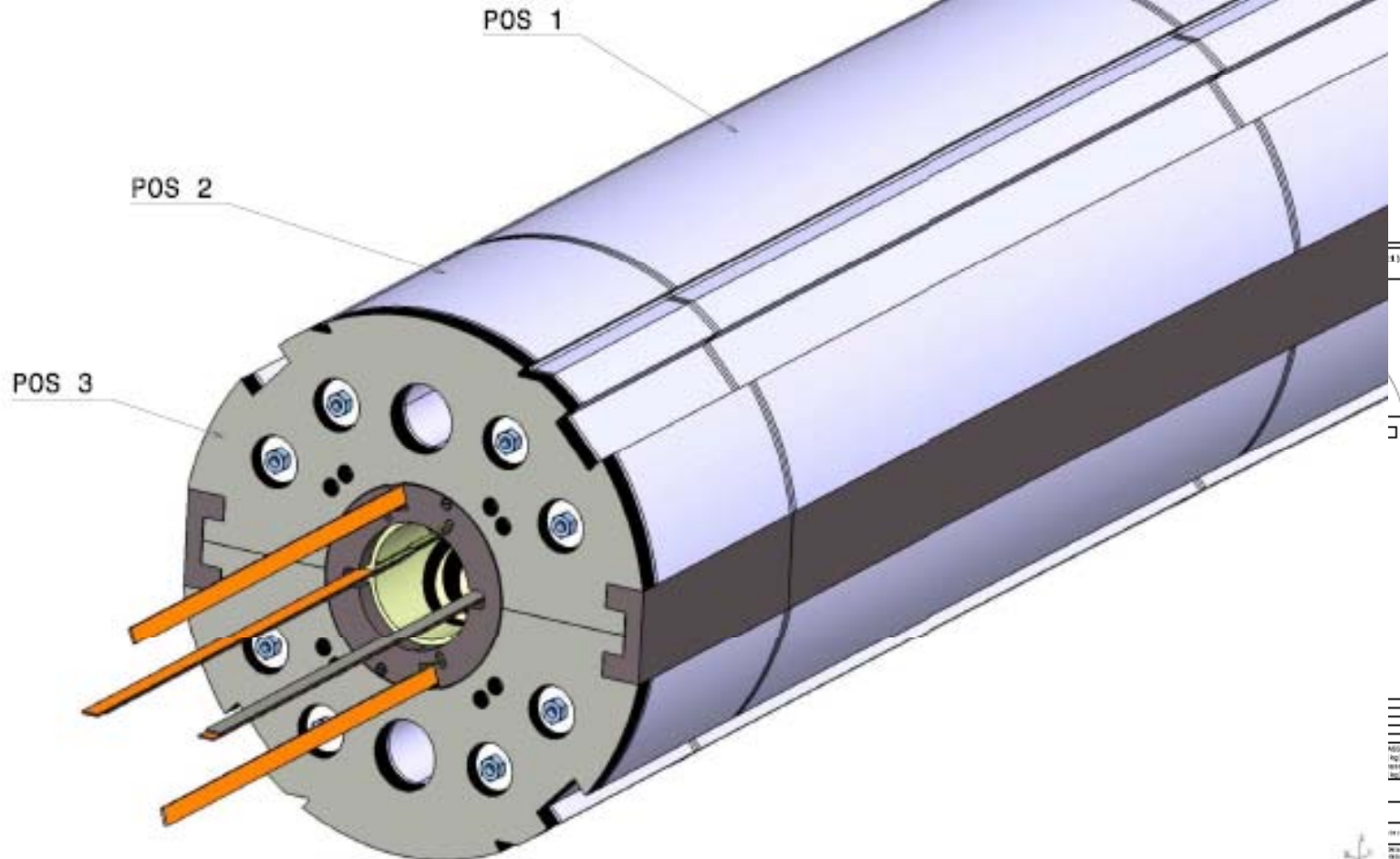

Disco Rap		ASG		ASG		ASG		ASG	
2007	ING 2	AI	AI	AI	AI	AI	AI	AI	AI
ASG		ASG		ASG		ASG		ASG	

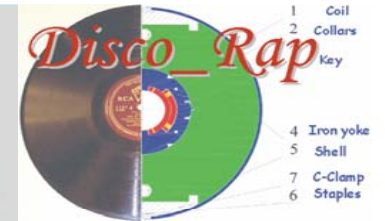

## Limits of INFN procurement

P.Fabbricatore

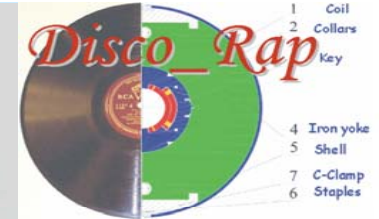

## FAIR-INFN MoU

4.2 Rutherford cable. As far as the Rutherford cable is concerned, the strategy is to perform the low losses superconductor development in two main stages, with decreasing filament diameters, keeping good electric transport and stability. Crucial role can play the development of winding models to test mechanical and structural aspects of the superconductive cable.

**Annex 4** shows the structure of the R&D programme for conductor development.

4.3 Construction and test of the cold mass. It is performed in collaboration with industry. An effective and fast way to construct the prototype is to re-utilize, after modifications, the LHC tools, which are available. INFN will set up a cold mass test station at the LASA Laboratory, where cold mass cryogenic and electrical tests, using a vertical cryostat, will be performed.

4.4 Design and construction of the horizontal cryostat. The integration between the cold mass and the horizontal cryostat will be performed at the LASA Laboratory, to be then sent to GSI for a test in real operating conditions.



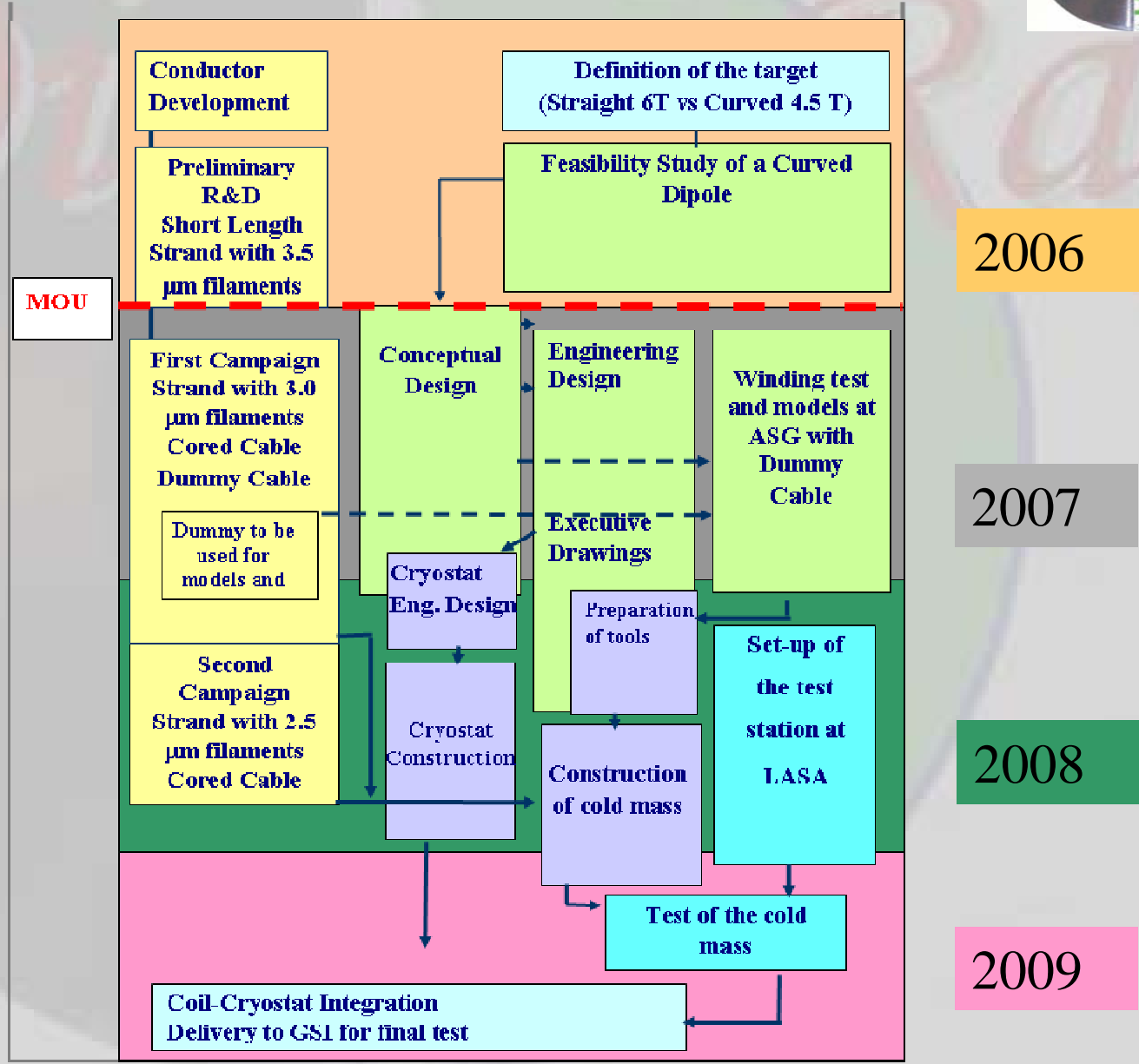
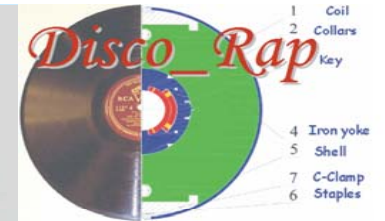

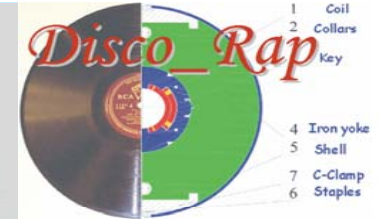

The spirit of the R&D was to:

- 1) Develop a robust design for the SIS300 cold mass supported by the construction of a real magnet
- 2) Develop a low loss conductor and the winding technologies
- 3) Develop the constructing technologies

We have to solve serious problems related to:

- 1) Winding technique of a curved cost dipole
- 2) The conductor
- 3) Fatigue in material and components

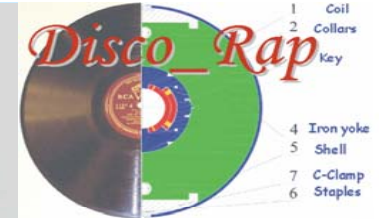

The main objective was to test the cold mass in field, temperature and heat exchange in conditions as real as possible for assessing the design choices.

According to us the horizontal cryostat should be strictly functional to this scope.

We were informed that there are ideas to use this magnet in a string. This implies that the magnet and cryostat shall be equipped with more complex ancillaries.

Apart that we are doubtful about the use in a string for this very first curved fast cycled magnet, we have no human and economical resources for procuring a cryostat different from the initial minimal hypothesis.

Some conflicts with the test in the vertical cryostat

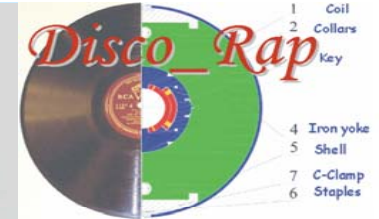

## Points with no or minor problems

vessel materials and technologies for cooling/shielding – outer vessel material, shield material, MLI insulation type and position

The pipe for the outer vessel shall be of dimensions and material available at the market.

Cryostat vessel material: Low carbon steel with improved low temperature properties (see LHC standards).

Thermal Shield: Al with proper RRR for the application.

MLI blankets (3 x 10 Layers) with fabric interlayer and punched foil for optimized degassing.

cryo line interfaces (@ 4.5K and shield temp) - kind of matching between cryostat and GSI cryo plant

The 4.5 K He supply at the GSI test bench is combined with bus bars coming from the current leads. For a proper connection of the cold mass to the test bench the He flow needs to be splitted by using a Y – tube.

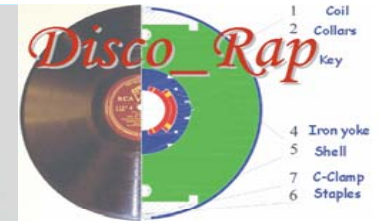

diagnostic line, vacuum ports – ports and feed through required for diagnostic and measurements

Definition of general interfaces, instrumentation and flange interfaces shall be defined as soon as possible by GSI. This concerns cryostat

- 1) main flanges
- 2) additional vacuum pumping port
- 3) vacuum measurement port
- 4) instrumentation interfaces

Cryostat end cap is included in the model magnet cryostat and shall already adapt the magnetic measurement to the cryostat (See test bench drawing).

Cryostat end cap: The Cryostat needs an end cap housing several equipment, e.g. cold mass terminator with short cut and an end cap shield. Adaptation between cold mass and adjacent devices need to be realised adjacent to the cold mass end caps.

The dimensional structure for the cold mass end cap interfaces shall be derived from information taken from B. Scokzen reports. Named reports will be transferred to INFN

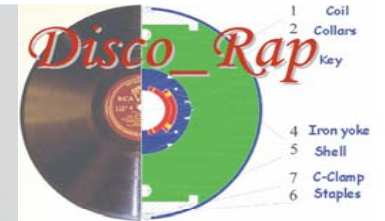

## Vacuum Vessel Topics:

Based on the actual design status the flanges of the cryostat vessel need to be tilted. The most probable solution is a straight cryostat with tilted flanges.

Additional pumping flange and cable feed through (1 or 2) for instrumentation are required. Feed through flanges will be equipped with LV and HV feed through connectors.

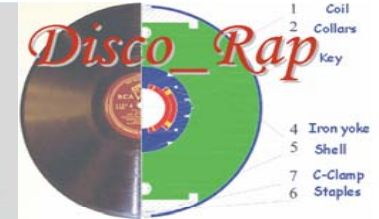

### Magnet support concept (LHC – type)

G11 supports (LHC Type , Rhic Type) is the intended concept for supporting the cold mass.

The model magnet should be equipped with one fixed (maybe rotatable) post and one sliding post (maybe guided sliding). The behaviour of such systems must be investigated and discussed carefully. This shall take place in close cooperation with GSI. FEM simulation and according analysis should be done by INFN.

A first CAD based concept of the cryostat shall be delivered by GSI. A first version of a cryostat specification will be developed by GSI during the running development process. One aim of the whole development process shall be a basic specification for the final ring type. Such specification must not exceed the INFN budget for the development. Thus the developed specification will finally not describe the model type but a basic ring type.

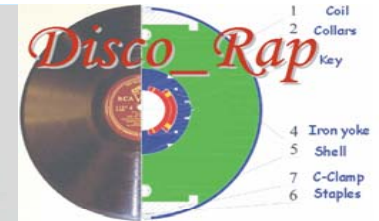

## Points with problems

perspectives and requirements for final cryostats - fiducials, tolerances, supports, available room in the tunnel, etc.

End cap is included in the model magnet cryostat and shall already adapt the magnetic measurement to the cryostat (See test bench drawing).

**High voltage feed throughs shall withstand a voltage 3 kV.**

Definition of the fiducials, tolerances, supports, available room in the tunnel, etc. was given in the introductory presentation.

Recooling has to be integrated in upper He line in the yoke. Thus the diameter will be increased.



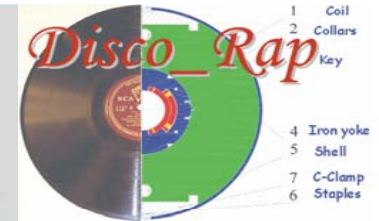

P. Schnizer needs to know the inner diameter of the bore tube.  
Available standard materials should be used for the bore tube.

Dear Umberto, First, IHEP will not install a beam tube in the magnet since they will test it in a vertical liquid helium dewar. This is something GSI will need to do, for testing the magnet in supercritical helium at GSI. We were also not able to find seamless 316 LN tubes on the market. Both RHIC and LHC used such beam tubes, but they ordered them in large quantities, so these were special orders, I presume. Hence, we thought that we should combine our order with yours, or maybe you could put our order on yours since we need only a short beam tube and it does not have to be curved. The engineer at GSI working on the adaptation of the 6T dipole model has found fabricators who could make such a beam tube in Germany , so I assume the same hold true for Italy. 304 N is not as stable as 316LN and shows ferromagnetic traces upon cyclic cooling, i.e. the magnetization increases with the number of cooling cycles. We may not want that. I sent you the name of a reference on ferromagnetic traces in austenitic stainless steels at 4.2 K a long time ago. Regards,  
Juris

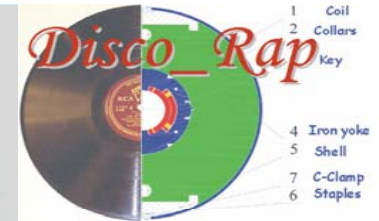

## Points large problems

room inside the cryostat for protection - cold diode

The diode box shall be designed by INFN. The Diode stack is a topic for the next session. One important aiming for the cold diodes is on the diode cooling.

Cold mass end cap is equipped with three bus bar feed throughs for the magnet in the ring. This scheme should ensure the possibility for reuse of the model dipole in a string test.

The model magnet shall be designed as close as possible aiming to the ring magnet design so that it can be reused in the string test.