

Choice of the electrical steel for DISCORAP dipole

- 1) Commercial electrical steel
- 2) Simple method for separating hysteretic, eddy currents and anomalous losses
- 3) Choice of a commercial steel lamination

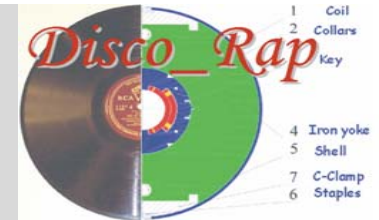

IEC 404-8-4 (1986)	EN 10106 (1995)	AISI	ASTM A677 (1989)	JIS 2552 (1986)	GOST 21427 0-75
-	M235-50A	-	-	-	-
250-35-A5	M250-35A	M 15	36F145	35A250	2413
270-35-A5	M270-35A	M 19	36F158	35A270	2412
300-35-A5	M300-35A	M 22	36F168	35A300	2411
330-35-A5	M330-35A	M 36	36F190	-	-
-	M250-50A	-	-	-	-
270-50-A5	M270-50A	-	-	50A270	-

M235-50A means that it is a magnetic steel (letter M), dissipating 2.35 W/kg at 50 Hz and B oscillating between - 1.5 T and + 1.5 T, the thickness is 0.5 mm

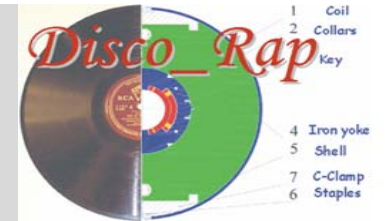

Category	Standard No.	Variety	Designation
Silicon Steel	Q/BQB 480-1999	Cold Rolled non-oriented silicon steel sheet in coil	B35A440, B35A550, B50A470, B50A540, B50A600, B50A700, B50A800, B50A1000, B50A1300, B65A600, B65A700, B65A800, B65A1000, B65A1300, B65A1600

Class	Nominal thickness mm	Theoretical density kg/dm ³	Core loss value P15/50 W/kg
B35A440	0.35	7.70	<=4.40
B35A550		7.75	<=5.50
B50A470	0.50	7.70	<=4.70
B50A540		7.70	<=5.40
B50A600		7.75	<=6.00
B50A700		7.80	<=7.00
B50A800		7.80	<=8.00
B50A1000		7.85	<=10.00
B50A1300		7.85	<=13.00
B65A600	0.65	7.75	<=6.00
B65A700		7.75	<=7.00
B65A800		7.80	<=8.00
B65A1000		7.80	<=10.00
B65A1300		7.85	<=13.00
B65A1600		7.85	<=16.00

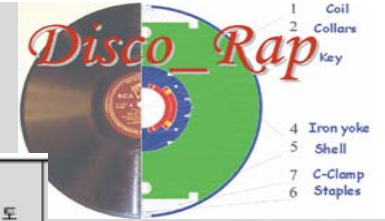

구 분 번호	구분	종 별		두께 (mm)	Maximum specific total loss(W/Kg) at 50 Hz		Minimum magnetic polarization(T) for each magnetic field strength(A/m)				Minimum stacking factor	최 대 철손이량성 (%)	최 소 공힌수	밀 도 (Kg/dm ³)		
		EN 10027-1	EN 10027-2		1.5T	1.7T	800	2500	5000	10000						
DIN EN 10107 (1995)	방향성 전기 장판	M080-23N	1.0860	0.23	0.80	1.27	1.75				0.945					
		M089-27N	1.0865	0.27	0.89	1.40	1.75				0.950					
		M097-30N	1.0861	0.30	0.97	1.50	1.75				0.955					
		M111-35N	1.0858	0.35	1.11	1.65	1.75				0.960					
		M120-23S	1.0864	0.23	0.77	1.20	1.78				0.945					
		M130-27S	1.0866	0.27	0.85	1.30	1.78				0.950					
		M140-30S	1.0862	0.30	0.92	1.40	1.78	-	-	-	0.955	-	1	7.65		
		M150-35S	1.0867	0.35	1.05	1.50	1.78				0.960					
		M100-23P	1.0879	0.23	-	1.00	1.85				0.945					
		M103-27P	1.0880	0.27	-	1.03	1.88				0.950					
		M105-30P	1.0886	0.30	-	1.05	1.88				0.955					
		M111-30P	1.0881	0.30	-	1.11	1.88				0.955					
		M117-30P	1.0882	0.30	-	1.17	1.85				0.955					
DIN EN 10106 (1995)	무 방 향 성 전 기 장 판	M235-35A	1.0890	0.35	2.35						0.95	±17	2	7.60		
		M250-35A	1.0800		2.50								2	7.60		
		M270-35A	1.0801		2.70	-	-	1.49	1.60	1.70				2	7.65	
		M300-35A	1.0803		3.00									3	7.65	
		M330-35A	1.0804		3.30									3	7.65	
		M250-50A	1.0891	0.50	2.50							0.97	±17	2	7.60	
		M270-50A	1.0806		2.70									±17	2	7.60
		M290-50A	1.0807		2.90			1.49	1.60	1.70				±17	2	7.60
		M310-50A	1.0808		3.10									±14	2	7.65
		M330-50A	1.0809		3.30									±14	3	7.65
		M350-50A	1.0810		3.50			1.50	1.60	1.70				±12	3	7.65
		M400-50A	1.0811		4.00	-	-	1.53	1.63	1.73				±12	5	7.70
		M470-50A	1.0812		4.70			1.54	1.64	1.74				±10	5	7.70
		M530-50A	1.0813		5.30			1.56	1.65	1.75				±10	10	7.70
		M600-50A	1.0814		6.00			1.57	1.66	1.76				±10	10	7.75
		M700-50A	1.0815	7.00			1.60	1.69	1.77			±10	10	7.80		
		M800-50A	1.0816	8.00			1.60	1.70	1.78			±10	10	7.80		
		M940-50A	1.0817	9.40			1.62	1.72	1.81			±8	10	7.85		
		M310-65A	1.0892	3.10								±15	2	7.60		
		M330-65A	1.0819	3.30	-	-	1.49	1.60	1.70			±15	2	7.60		
		M350-65A	1.0820	3.50								±14	2	7.60		
		M400-65A	1.0821	4.00			1.52	1.62	1.72			±14	2	7.65		
		M470-65A	1.0823	4.70			1.53	1.63	1.73			±12	5	7.65		
		M530-65A	1.0824	5.30			1.54	1.64	1.74			±12	5	7.70		
		M600-65A	1.0825	6.00	-	-	1.56	1.66	1.76			±10	10	7.75		
		M700-65A	1.0826	7.00			1.57	1.67	1.76			±10	10	7.75		
		M800-65A	1.0827	8.00			1.60	1.70	1.78			±10	10	7.80		
		M1000-65A	1.0829	10.00			1.61	1.71	1.80			±10	10	7.80		
		M600-100A	1.0893	6.00			1.53	1.63	1.72			±10	2	7.60		
		M700-100A	1.0894	7.00			1.54	1.64	1.73			±8	3	7.65		
M800-100A	1.0895	8.00	-	-	1.56	1.66	1.75			±6	5	7.70				
M1000-100A	1.0896	10.00			1.58	1.68	1.76			±6	10	7.80				
M1300-100A	1.0897	13.00			1.60	1.70	1.78			±6	10	7.80				

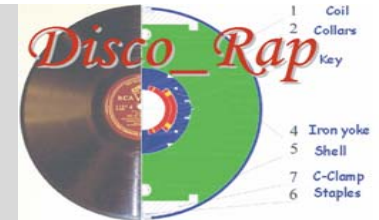

The Si content has been used as main parameters for evaluating electrical and magnetic properties

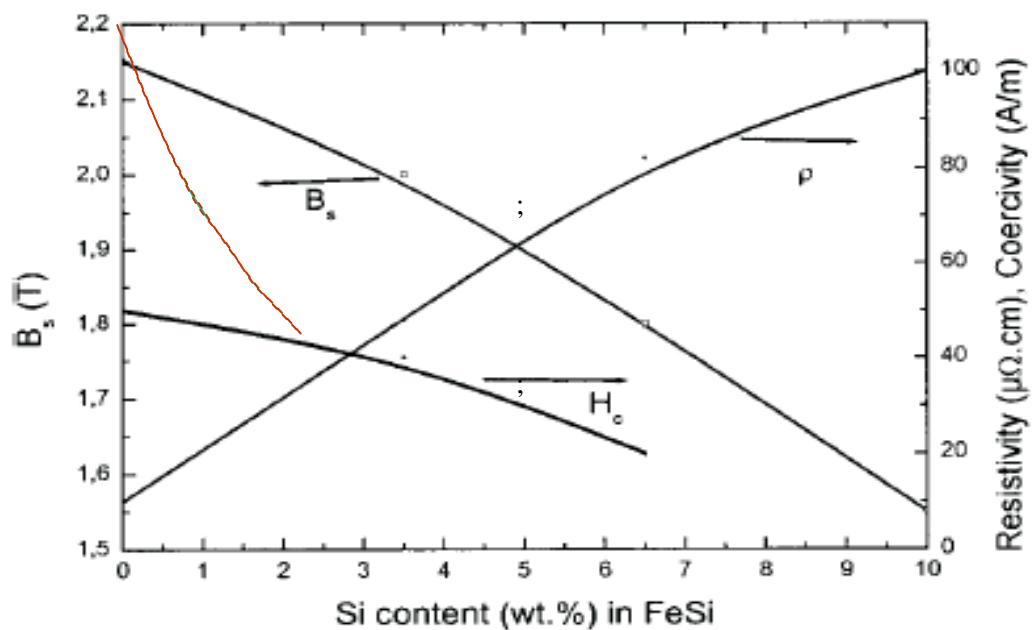

Figure 1. Evolution of intrinsic features as a function of Si content in Fe-Si.

$$H_c(x) \left[\frac{A}{m} \right] = 110 * e^{\left(-\frac{x}{3.7} \right)}$$

$$\rho(x) [\Omega m] = 1.3 \cdot 10^{-7} + 8.7 \cdot 10^{-8} x$$

$$B_{sat}(x) [T] = 2.16 - 0.028x - 0.004x^2$$

x = Si content (wt.%)

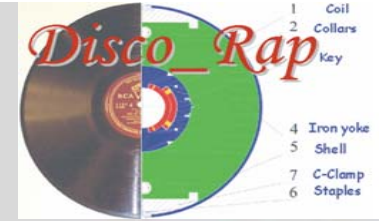

Calibration using known properties of a steel lamination, using a FE calculation applied to a plate of 1 kg

Steel	Hysteretic at 50 Hz and \pm 1.5T (W/kg)	Eddy Currents at 50 Hz and \pm 1.5 T (W/kg)	Anomalous at 50 Hz and \pm 1.5T (W/kg)	Hysteretic at 0.056 Hz and $\pm B_{sat}$. (mW/kg)	Eddy Currents at 0.056 Hz and $\pm B_{sat}$. (mW/kg)	Anomalous at 0.056 Hz and $\pm B_{sat}$. (mW/kg)
11200-100A	2.62	5.44	3.94	5.013	0.014	0.024

$$E_H [J / m^3] = \eta B_{max}^\alpha$$

$$E_E [J / m^3 cycle] = \frac{d^2}{12\rho} \omega B_{max}^2 \pi$$

$$E_A [J / m^3 cycle] = 8.73 \sqrt{\frac{GV_0 S}{\rho}} f^{0.5} B_{max}^{1.5}$$

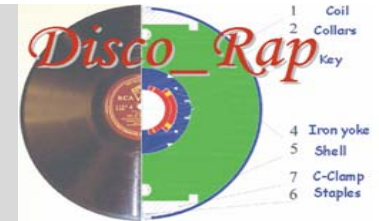

Steel	Hysteretic at 50 Hz and $\pm 1.5T$ (W/kg)	Eddy Currents at 50 Hz and $\pm 1.5 T$ (W/kg)	Anomalous at 50 Hz and $\pm 1.5T$ (W/kg)	Hysteretic at 0.056 Hz and $\pm B_{sat}$ (mW/kg)	Eddy Currents at 0.056 Hz and $\pm B_{sat}$ (mW/kg)	Anomalous at 0.056 Hz and $\pm B_{sat}$ (mW/kg)
M235-35A	1.7	0.4	0.25	3.10	0.000	0.016
M300-35A	2.0	0.6	0.4			
M250-50A	1.4	0.7	0.4	2.54	0.0016	0.023
M350-50A	1.9	0.9	0.7			
M350-65A	1.6	1.2	0.7			
M600-100A	1.4	2.7	1.9	2.54	0.006	0.11

M250-50A and M600-100A seem the most suitable steel lamination. Our preference is for M600-100A, because the larger thickness allows to handle less number of plates

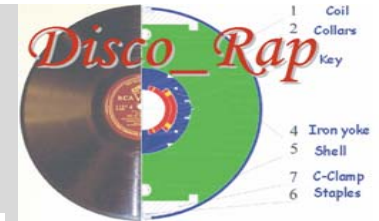

Materials and lay-out for collars of **DISCORAP dipole**

- 1) Function of the collar in DISCORAP dipole
- 2) Review of existing dipole collars
- 3) Towards a possible lay-out
- 4) Choice of material

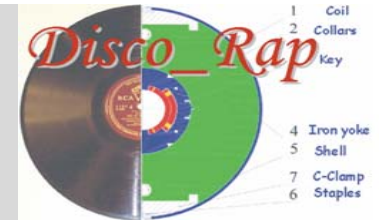

Since the beginning of our R&D activities we did the choice to have the coil mechanically supported only by the collars.

This choice was mainly determined to limit the difficulties coming from the need to couple a curved collared coil with a curved yoke.

This approach can be considered of **HERA-type**, with the difference that we will use stainless steel collars.

We agreed with GSI that a relevant parameters was the coil deformation during the field variation from 1.5 T to 4.5 T. The maximum allowed deformation was fixed to about **50 μm** . As a consequence a collar of **30 mm** thickness was necessary, according the FE mechanical computations.

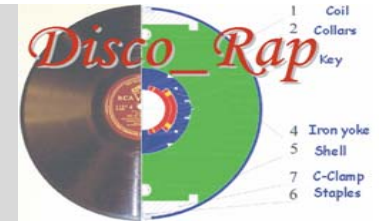

To set a maximum deformation is clearly related to different issues:

- 1) Minimization of harmonics variation during the field ramp
- 2) Minimization of heat releases due to the friction or local heat releases
- 3) Minimization of strain/stress variations in a frame of fatigue problematic (peculiarity of SIS300)

Recent developments of the conceptual design clearly show that deformations larger than the agreed one are not necessarily worsening the field quality (See SF presentation). This would open the way to a reduction of the collar thickness, which has positive effects on temperature (and then stability) margin. I am now presenting a comparison between DISCORAP/SIS300 with other magnets to be followed, later, by a discussion about the basic reasons leading to limit the coil deformation to a given value.

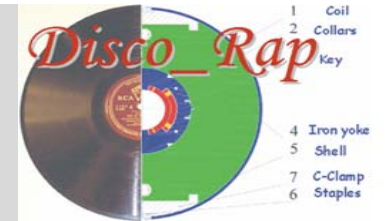

Magnet →		GSI001	
B (T)	Φ_{int} (mm)	Collar thickness (mm)	Self-support
4	80	19 (?)	(?)

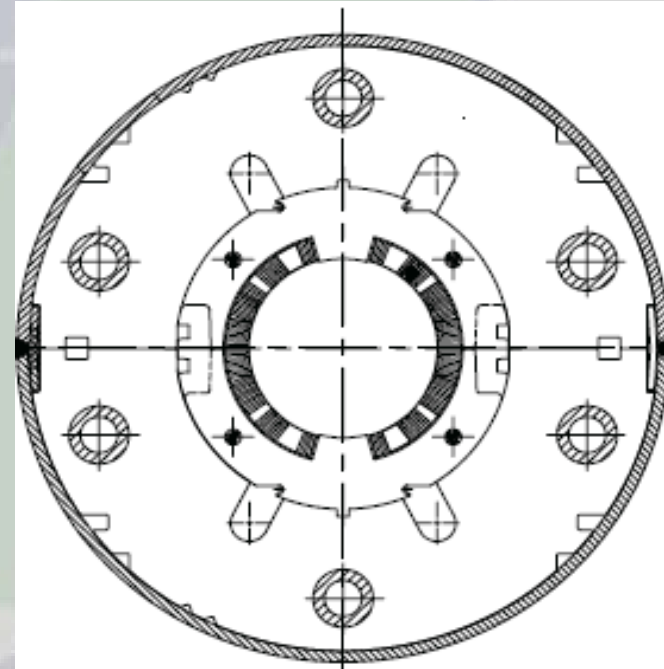
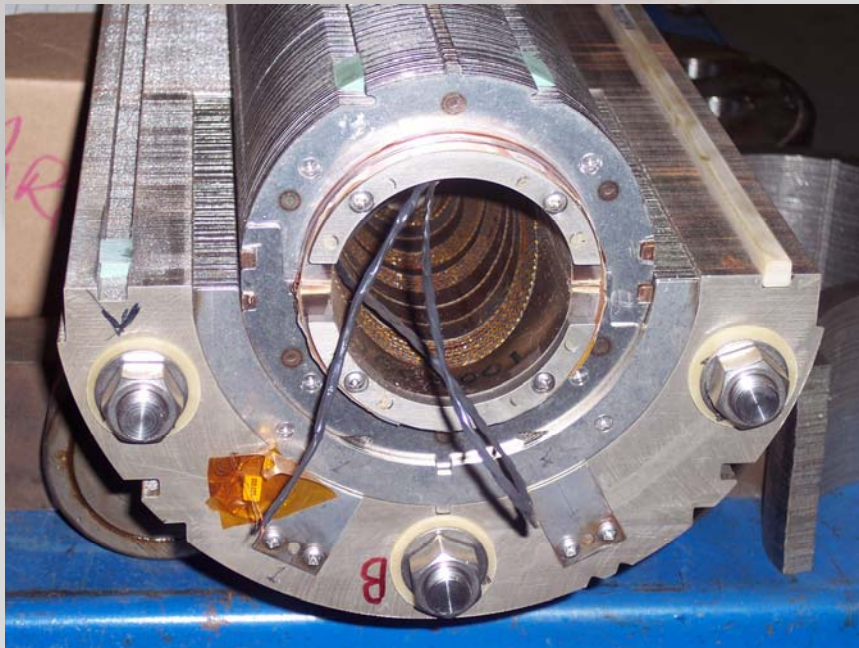

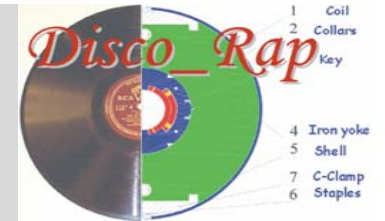

Magnet →	Tevatron		
B (T)	Φ_{int} (mm)	Collar thickness (mm)	Self-support
4.2-4.4	~ 76	~ 11-13	Yes

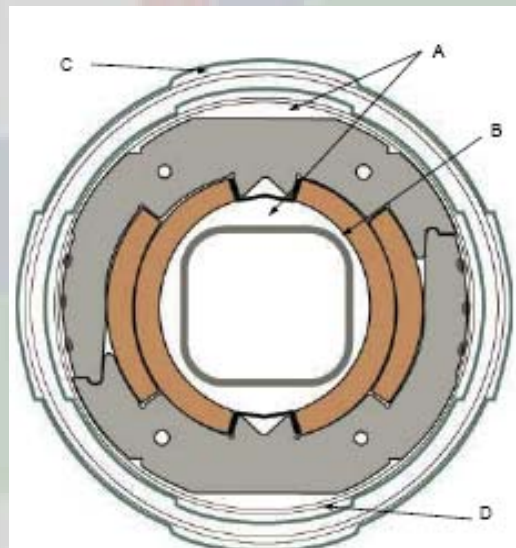

The cold mass is assembled in a compact cryostat which contains a liquid helium cooled shield and a liquid nitrogen cooled shield.
 A-Single phase (supercritical) helium
 B-Beam tube
 C-Liquid nitrogen shield
 D-Liquid helium shield (two-phase)

Warm iron

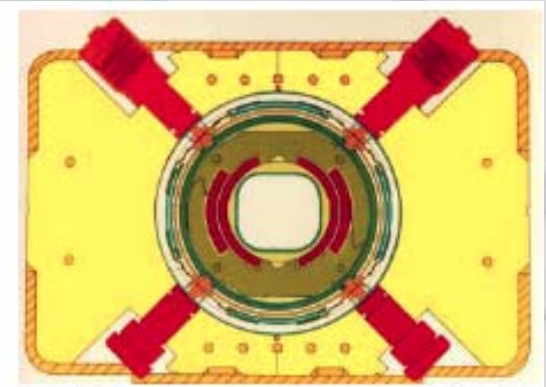

Tevatron dipole. This magnet has a warm iron yoke and a collared coil assembly in a close-fitting cryostat.

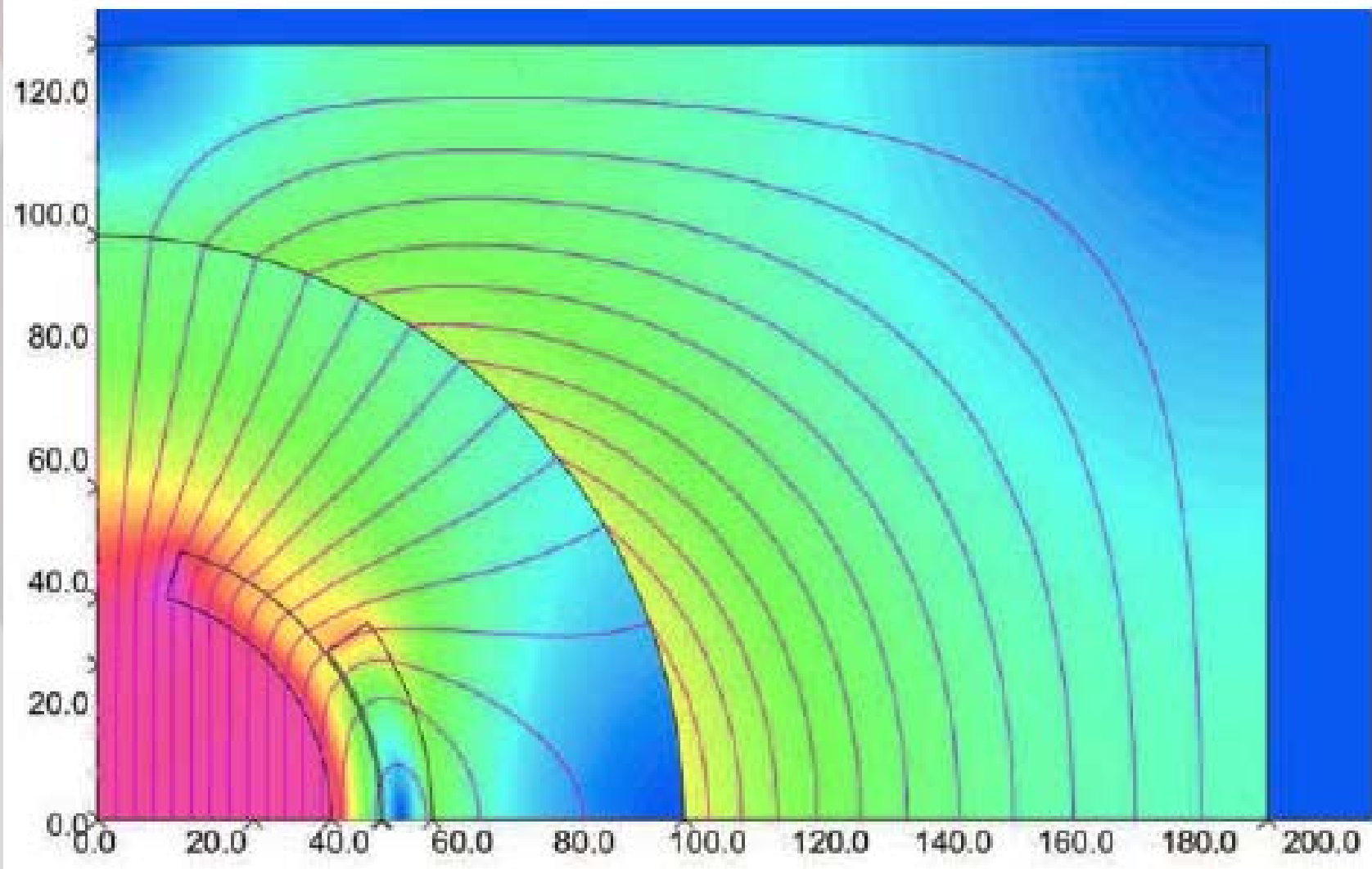
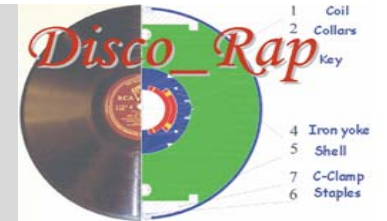

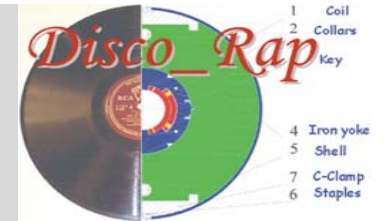

Magnet →	SSC		
B (T)	Φ_{int} (mm)	Collar thickness (mm)	Self-support
6.6	~ 50	~ 17	(?)

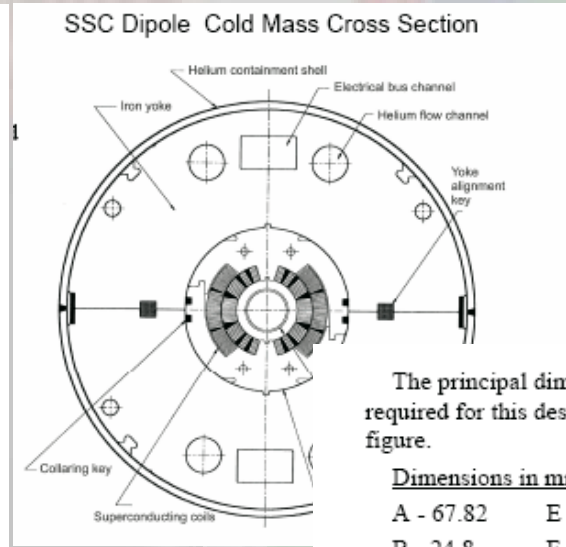
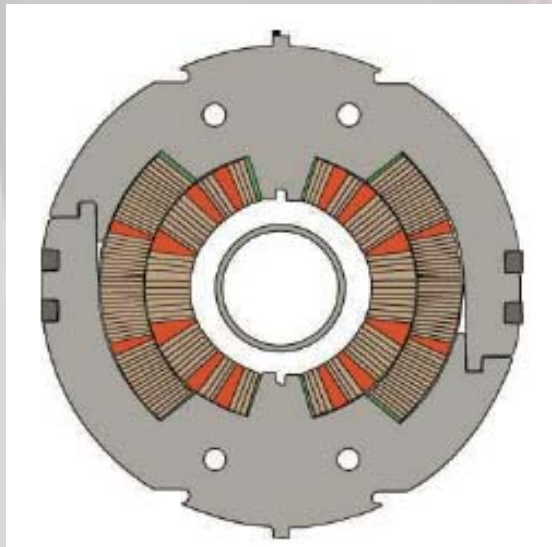

The principal dimensions of the collar required for this design are shown in the figure.

Dimensions in mm:

- A - 67.82 E - 102.68 deg.
- B - 24.8 F - 35.86 deg.
- C - 37.92
- D - 50.83

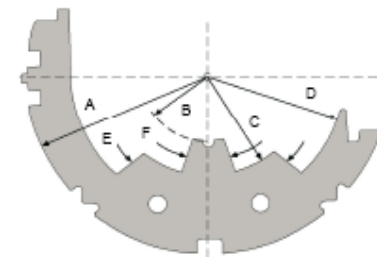

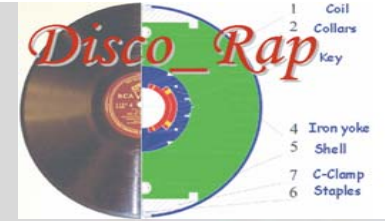

Magnet →	HERA		
B (T)	Φ_{int} (mm)	Collar thickness (mm) Al-alloy	Self-support
5.2	~ 75	28.6	Yes

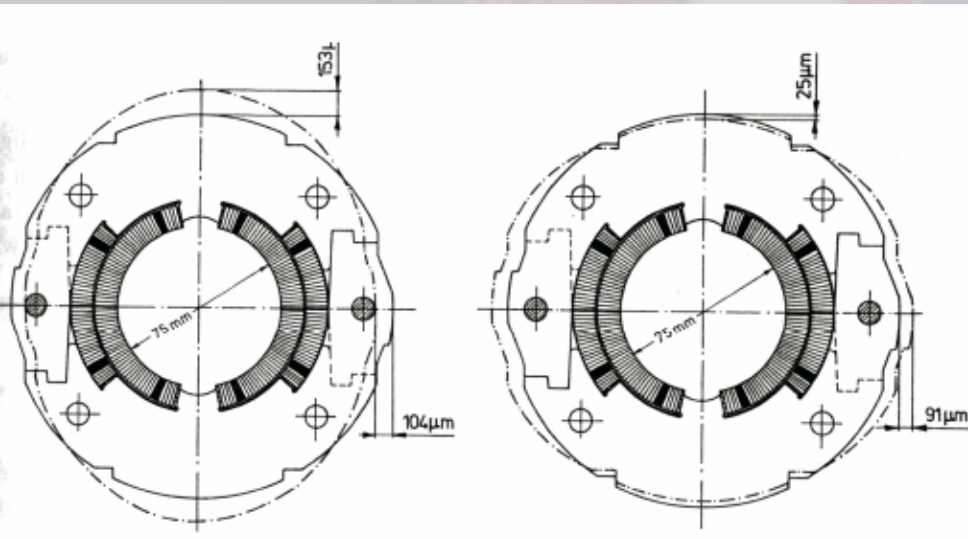

A - Nominal fit of HERA collar in yoke.

B - Calculated deflection (dotted lines) of prestressed coils in collar. Room temperature coil is on the left and operating condition coil with Lorentz force is on the right. From K.-H. Mess, P. Schmuser and S. Wolff, "Superconducting Accelerator Magnets", World Scientific Publishing Co., Singapore

B

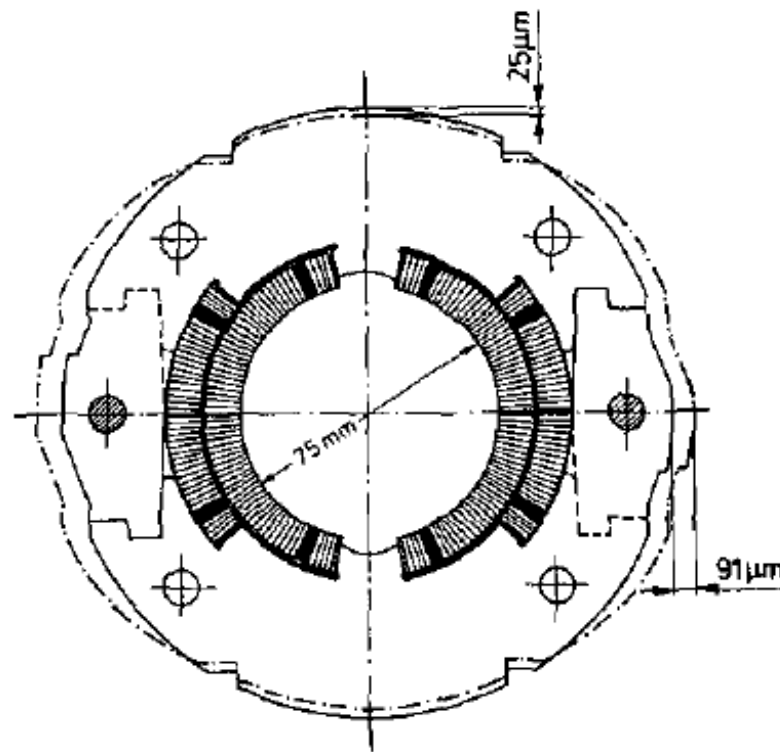
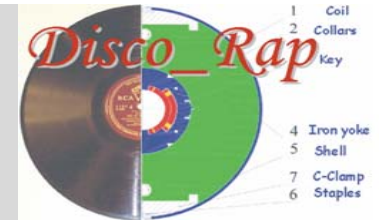
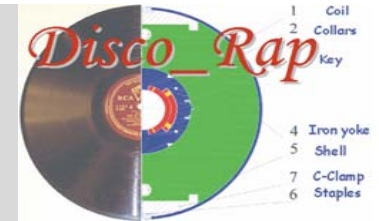

Figure 3.7. Calculated deformation of the collared HERA coil at 6 T. The collar material is aluminium AlMg4.5Mn(G35) with a value of $\sigma_{02} \approx 270$ MPa and a yield strength of 350 MPa. The maximum calculated stress in the collar is 150 MPa. The calculation was performed by G Meyer of DESY. In a test set-up with a mechanical load applied to a short stack of collar laminations the measured and computed deflections agreed to within 5%.



In order to compare the different configurations we should know the magnetic deformations. In fact the deformations are quite complex and not known. I propose a figure of merit, which could be defined as a sort of equivalent deformation defined as :

$$\varepsilon = \left(\frac{B_0^2}{2\mu_0} \right) \frac{R_{\text{int collar}}}{\Delta R_{\text{collar}}} \frac{1}{Y}$$

Magnet	ε
GSI001	$9.00 \cdot 10^{-5}$
Tevatron	$1.62 \cdot 10^{-4}$
SSC	$2.55 \cdot 10^{-4}$
HERA	$2.95 \cdot 10^{-4}$
DISCORAP	$9.21 \cdot 10^{-5}$

One can see that DISCORAP would be much more conservative if its ε is compared to existing magnets (considered here self supported as surely true for HERA and TEVATRON)

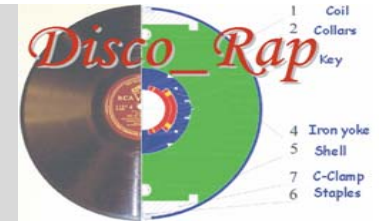

Structure of the collars

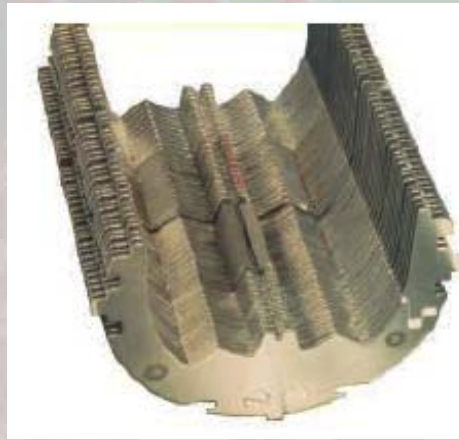
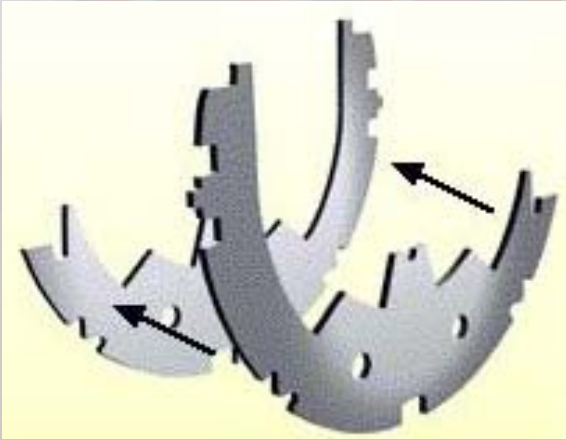

All showed magnets have a collar structure composed by two elements composing a cylindrical containment (4 elements are needed for guaranteeing the circular continuity).

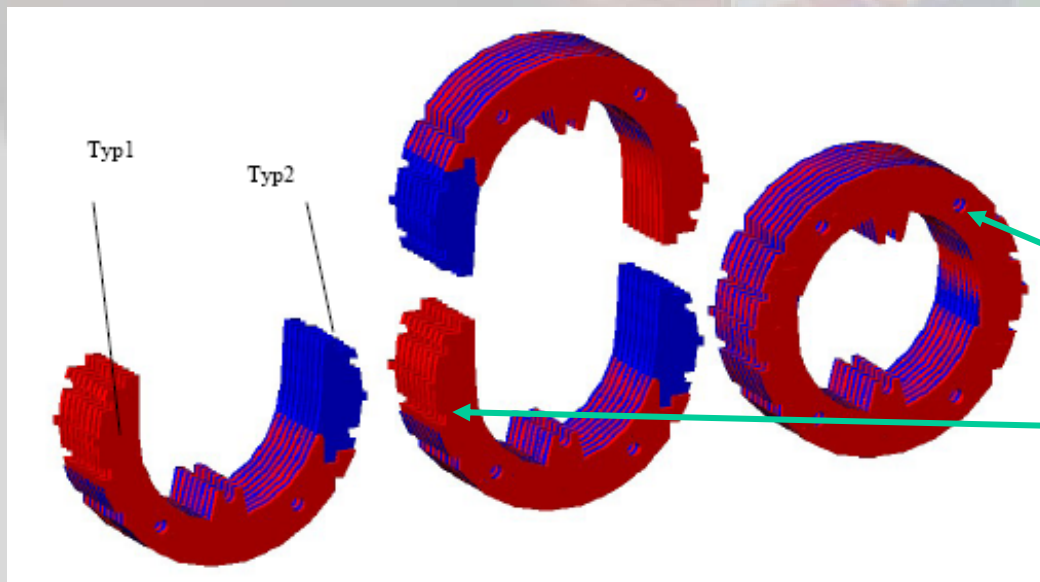

The 2D mechanical analyses were done using an homogeneous material. More refined 3D analyses are required for calculating peak stress around pins and keys.

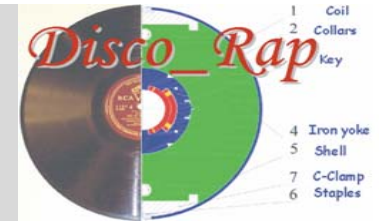

A different collar

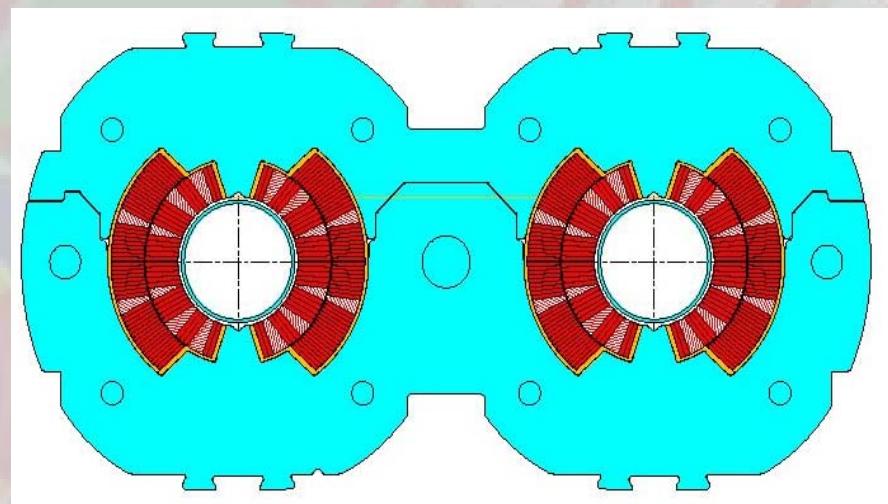
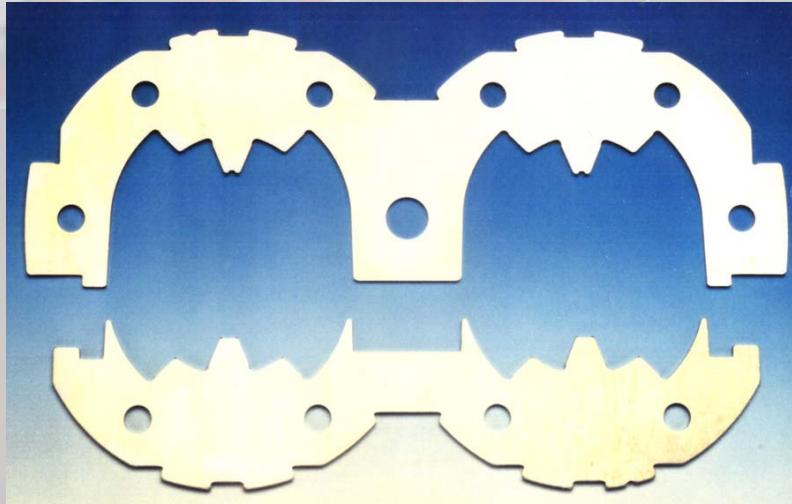

LHC dipoles (due to their peculiarity to being two-in-one), used a different collar. In fact only one part of the collar has a mechanical function, the other being a sort of filler/closure. When assembling these collars in the usual way, the radial rigidity is strongly reduced (down to $\frac{1}{2}$). Not having yet defined the precise collar lay-out, mechanical simulations were also done using an artificial Young modulus lower than the one of the material. In these case the **deformations are larger and the peak stresses too.**

Personally I think that this design shall be avoided in our case

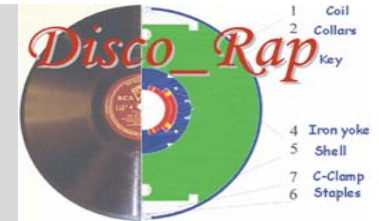

Material to be used in collars

The magnetic analyses showed that only a very low value of magnetic permeability is allowed (1.003) leading to a choice of high strength austenitic steel

Table 1 Properties of non-magnetic steel (KHMN) (plus AISI 316LN) (1.5 mm cold rolled)

Items		Target (SSC)		KHMN		316LN(Ref.)	
		RT	4K	RT	4K	RT	4K
Magnetic permeability	Absolute value, μ	≤ 1.002		1.0009	1.0010	1.008	1.017
	Deviation, $\Delta \mu$	≤ 0.0005		± 0.0002	± 0.0002	± 0.002	± 0.005
Thermal contraction	Coefficient (80 ~ 300K, K^{-1})	equal to or less than those of iron		7.5×10^{-6}		7.5×10^{-6}	
	Displacement (4 ~ 300K, mils/in)			1.7		3.1	
0.2% proof strength		≥ 630	≥ 1200	690	1500	580	1420
Tensile strength				830	1720	850	2250
Total elongation		(as large as possible)		33	29	40	34
Charpy impact absorption energy (J)				274	135	290	120

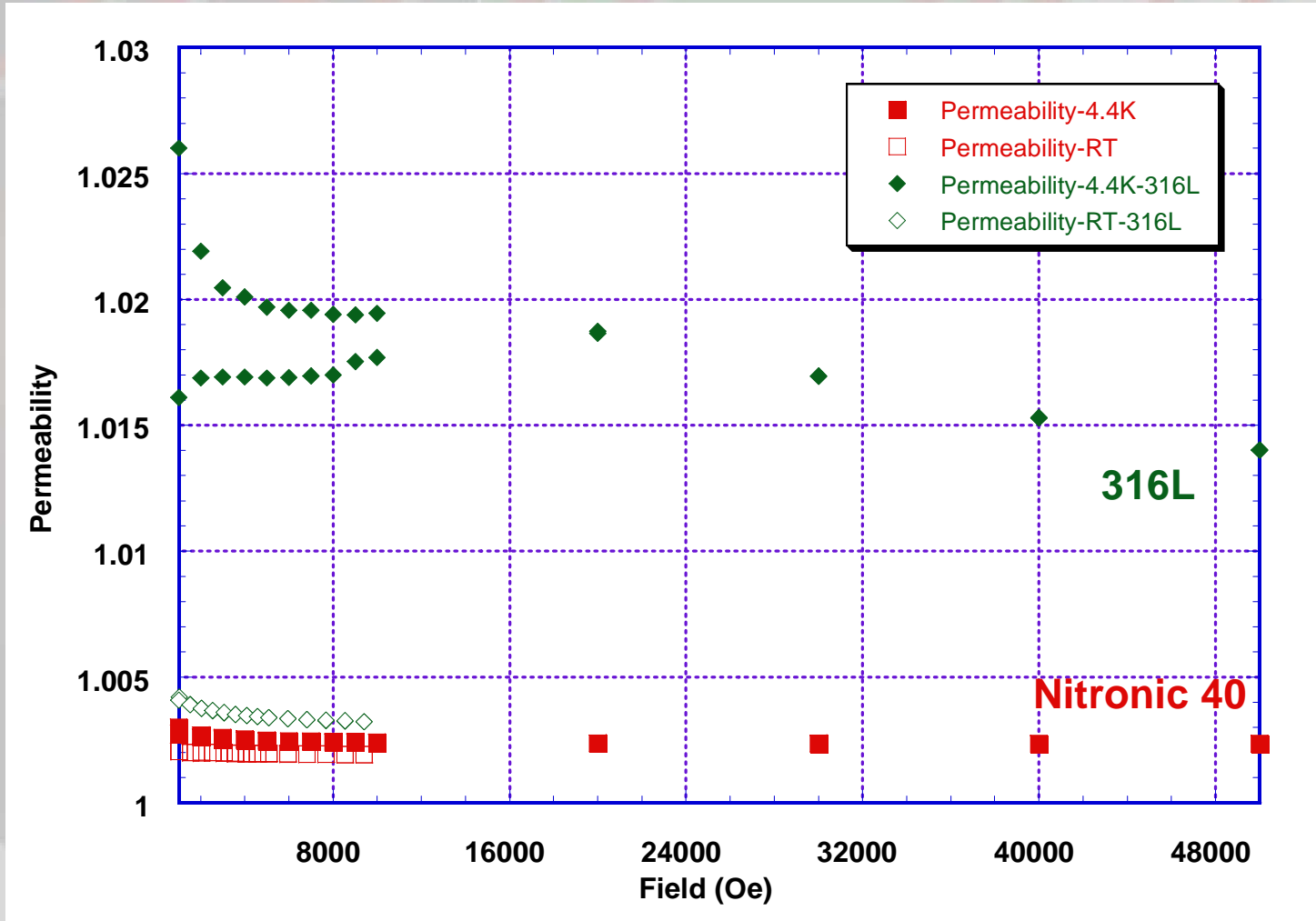
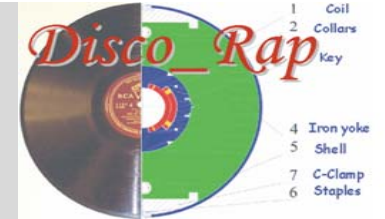

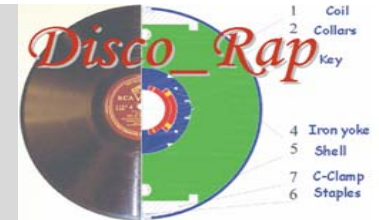

	Nitronic 40		Hi Mn steel	
Temp (K)	295	4	295	4
Y. S. (MPa)	682.51	1427.06	675.61	1482.21
T. S. (MPa)	889.33	1813.12	813.49	1695.92
Elongation	29%	23	33%	29%
μ	1.0019	1.0021	1.0009	1.001
E (GPa)	192		188	
Note	4		5	

3.1 METALS AND ALLOYS (293K TO 4.2K)

MATERIAL	$\epsilon = \Delta L / L_0$	COMMENT
Nitronic 40, SSC collar material	0.00241	High strength stainless steel used for collars
HiMn, collar material (KH Mn30L)	0.00157	High strength stainless steel used for collars

TYPE	C MAX.	Mn MAX.	P MAX.	S MAX.	Si MAX.	Cr	Ni	Mo MAX.	OTHER ELEMENTS
18-9LW	0.10	2.00	.045	.030	1.00	17.00-19.00	8.00-10.00	—	Ba C Mm
Nitronic 32	0.15	11.00-14.00	.060	.030	1.00	16.50-19.00	.5- 2.50	—	Cu3.0-40
Nitronic33	0.08	1150-1450	.060	.030	1.00	17.00-19.00	2.25-3.75	—	N .20-45
Nitronic 40	0.08	8.00-10.00	.060	.030	1.00	19.00-21.00	5.50- 7.50	—	N.20.40
Nitronicso	.03-06	4.00- 6.00	.040	.030	1.00	20.50-23.50	11.50-13.50	1.50-3.00	N .15-40 N .20-40

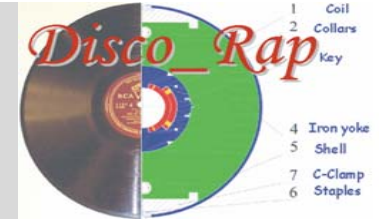

The LHC experience

TABLE I
GRADES TESTED

Grade	Producer
13RM19®	Sandvik
20-7 MN®	Ugine
YUS 130 S®	Nippon
Hyform 200 mod.®	Avesta Sheffield
KHMN®	Kawasaki

TABLE IV
THERMAL CONTRACTION ($\Delta L/L$) BETWEEN ROOM TEMPERATURE AND 1.9 K

Grade	Thermal contraction $\Delta L/L$
13RM19	$2.7 \cdot 10^{-3}$
20-7 MN	$2.7 \cdot 10^{-3}$
YUS 130 S	$2.6 \cdot 10^{-3}$
Hyform 200 mod.	$2.7 \cdot 10^{-3}$
KHMN	$1.8 \cdot 10^{-3}$

TABLE II
NOMINAL CHEMICAL COMPOSITION (% OF TOTAL WEIGHT)

Grade	C	Si	Mn	P	S	Cr	Mo	Ni	N
13RM19	0.11	0.85	6.4	0.01	0.01	16.8	0.38	7.2	0.26
20-7 MN	0.03	0.22	9.12	0.02	0.002	29	0.032	8.86	0.4
YUS 130 S	0.09	0.4	10.7	0.022	0.004	18	0.1	8.6	0.32
Hyform 200 mod.	0.1	0.35	6.8	0.023	0.001	16.4	0.14	7.9	0.26
KHMN	0.1	0.6	28	0.022	0.004	6.7	<0.1	0.82	0.1

TABLE VII
MECHANICAL PROPERTIES AT 77 K

Grade	$\sigma_{0.2}$ (MPa)	σ_R (MPa)	A_5
13RM19	1113	1634	66%
20-7 MN	1136	1660	46%
YUS 130 S	1023	1595	48%
Hyform 200 mod.	936	1533	65%
KHMN	1050	1600	50%

We should avoid high Mn steel (too low thermal contraction, requiring more pre-stress). As a summary of these materials, Nitronic 40 seems the most suitable one for DISCORAP/SIS300

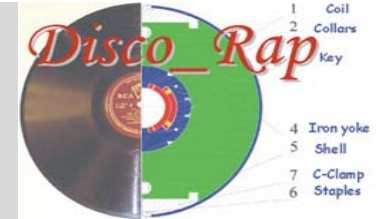

Conclusions

- 1) There are arguments leading to reduce the actual collar thickness (30 mm)
- 2) The collar lay-out could be HERA or SSC type
- 3) The material envisaged material is Nitronic 40
- 4) The thickness shall be decided. However, on the basis of FE analyses it could be about 2mm (Heat dissipation about 3 mW/m)