

The Engineering Design of the Cold Mass

Reported by R. Marabotto

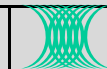

CONDUCTOR INSULATION

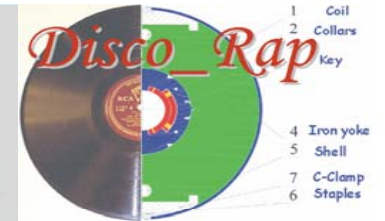

Kapton Tape : 0.025 x 20 mm

Adhesive Kapton Tape: 0.0686 x 9 mm

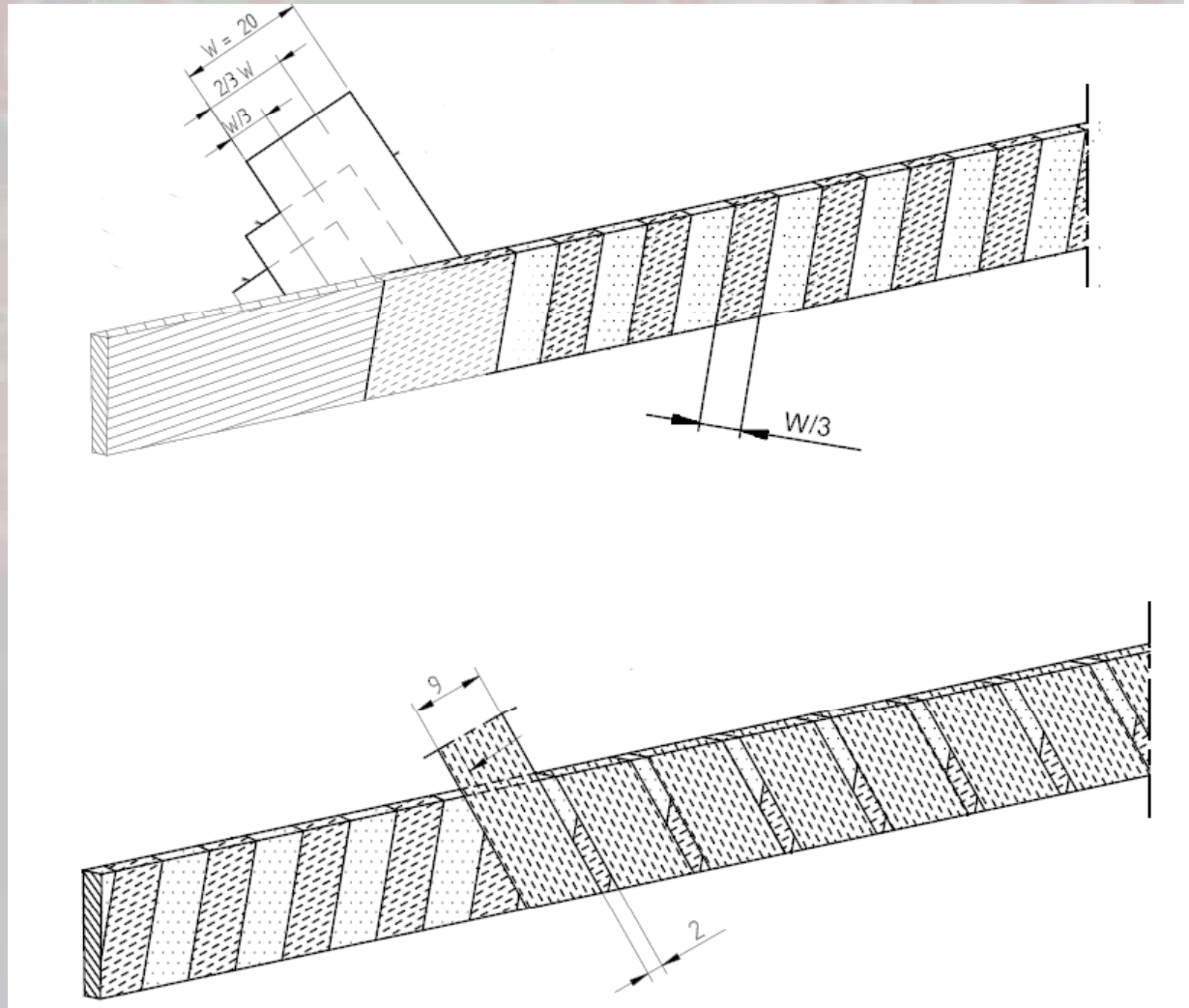
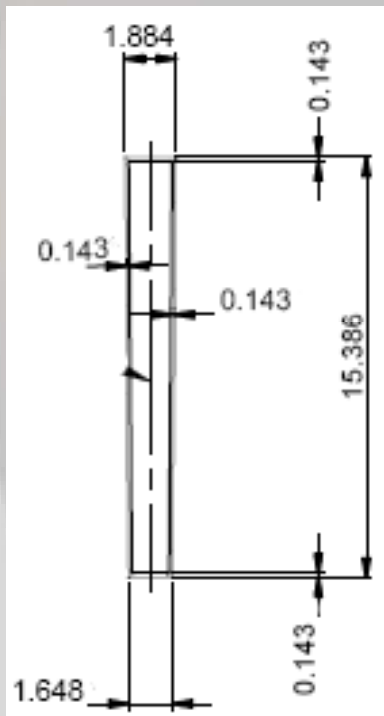

CONDUCTOR INSULATION

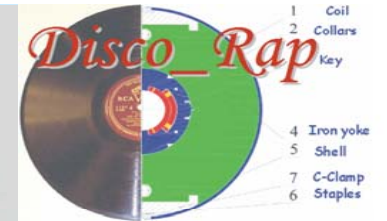

Conductor Insulation Process:

- Cleaning
- Drying
- Taping
- Dimensional & Spark test
- Spooling



COIL SPACERS

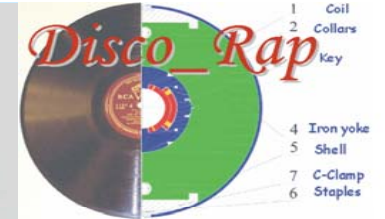

G11 End Spaces

ROXIE FILE → CAD SURFACE SMOOTHING → 5 Axis CNC Machining

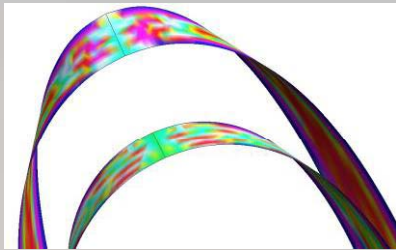

VARIATION OF CURVATURE RADIUS
IN THE THICKNESS DIRECTION
BEFORE AND AFTER
SURFACE SMOOTHING

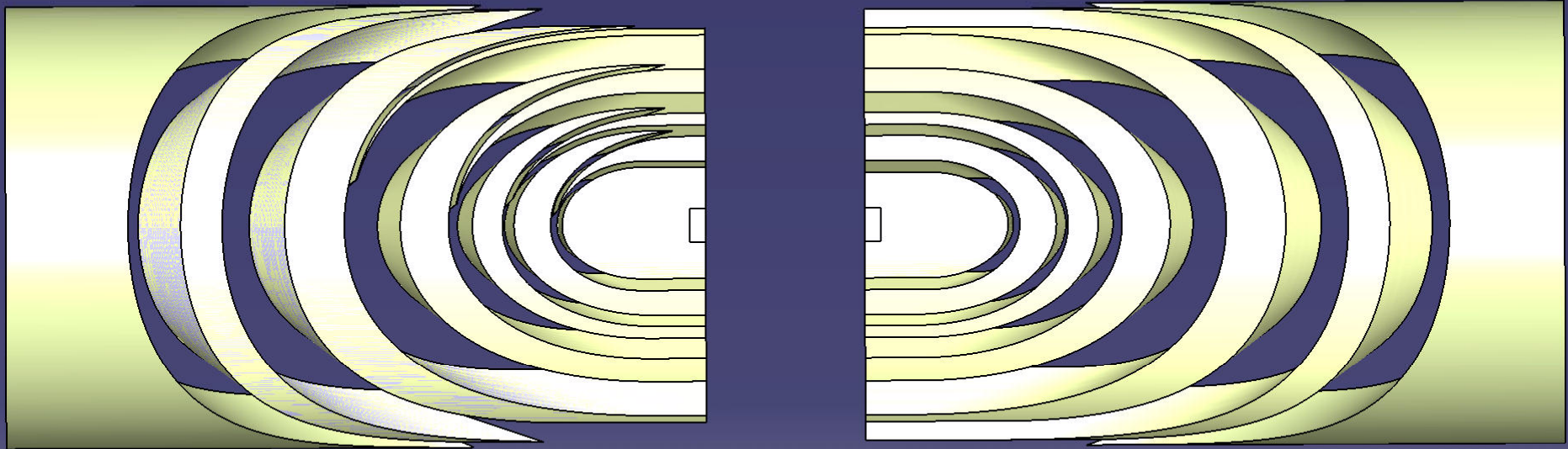
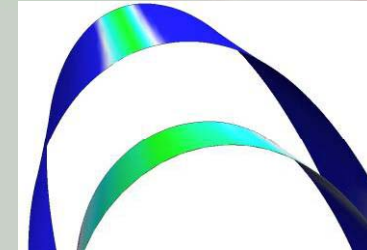

COIL SPACERS

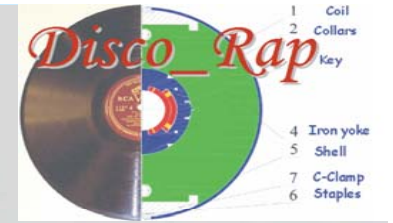

COIL SPACERS

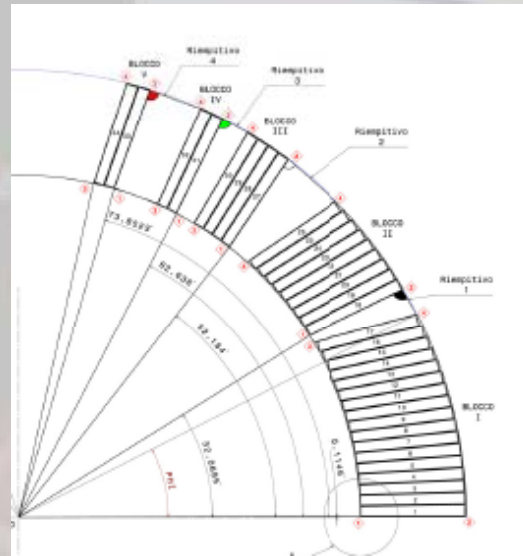
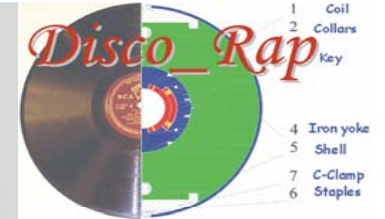

G11 Wedges

1 m long pieces

Toll.: +/- 0.05 mm

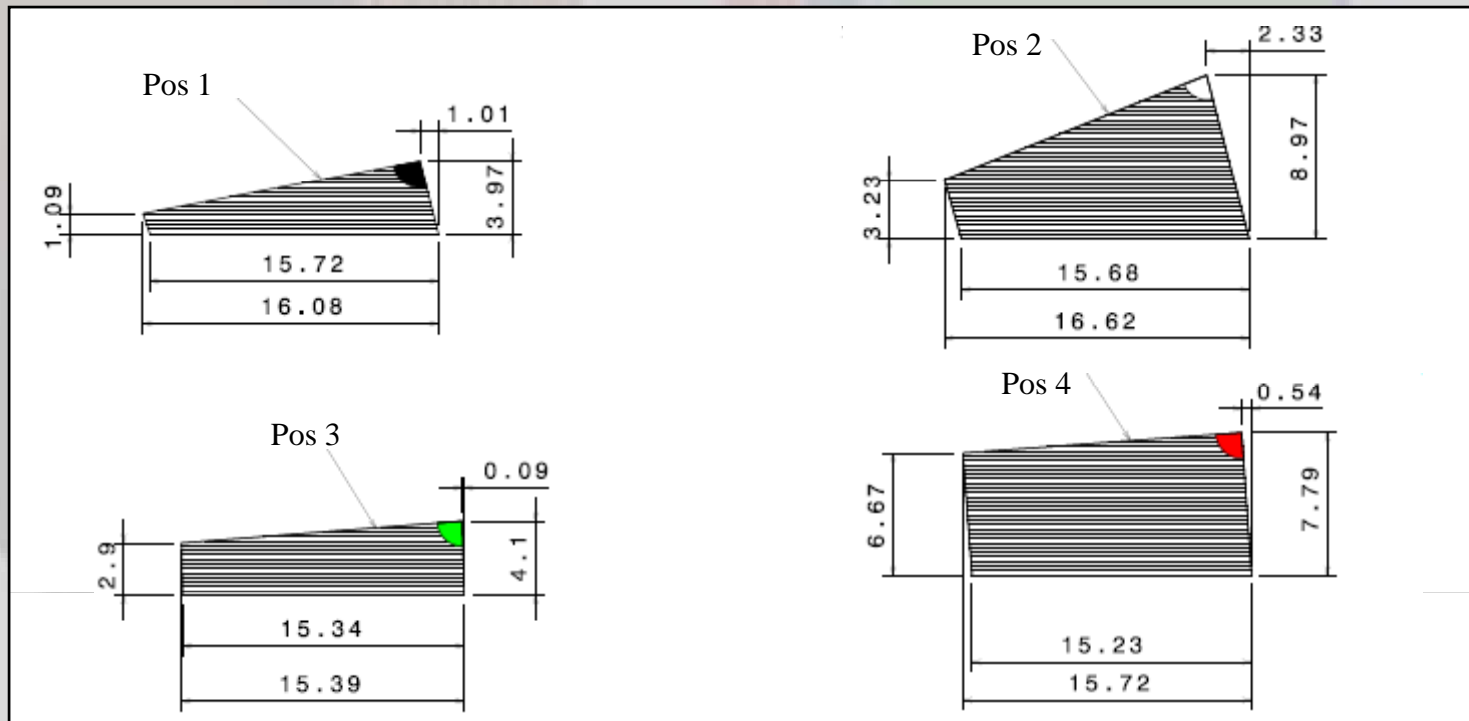

COIL SPACERS

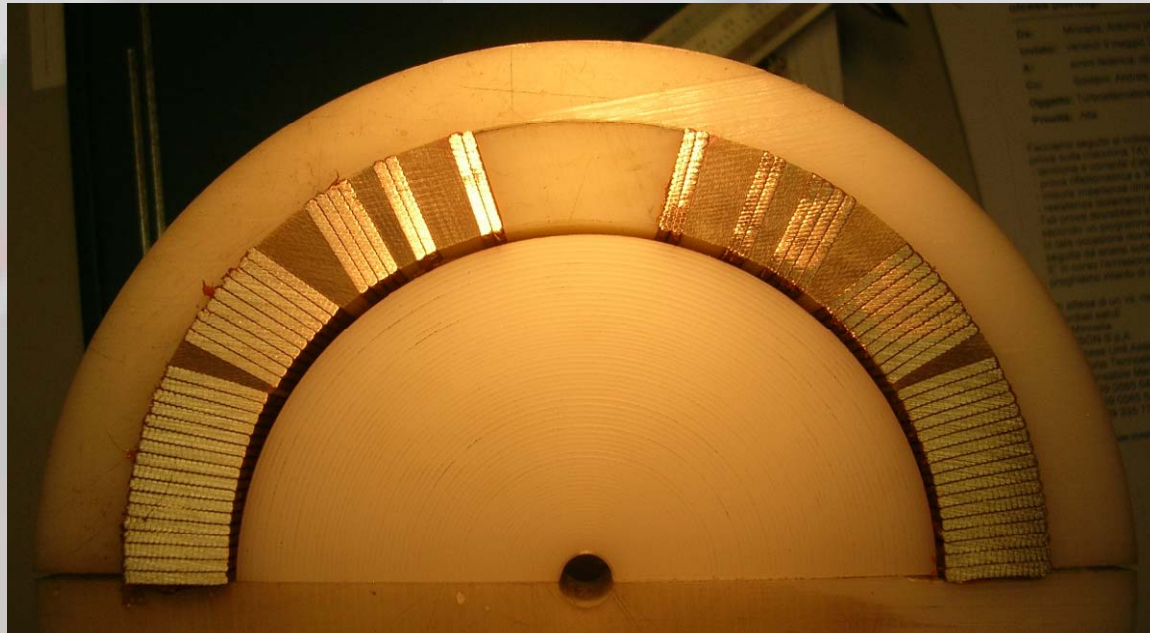
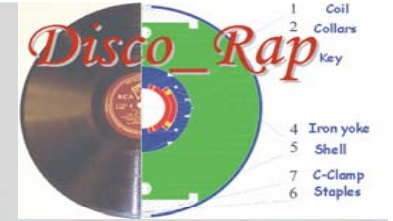

COIL WINDING

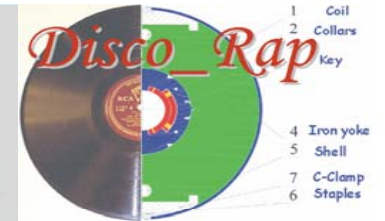

Clockwise Winding for Both Upper and Lower Coils

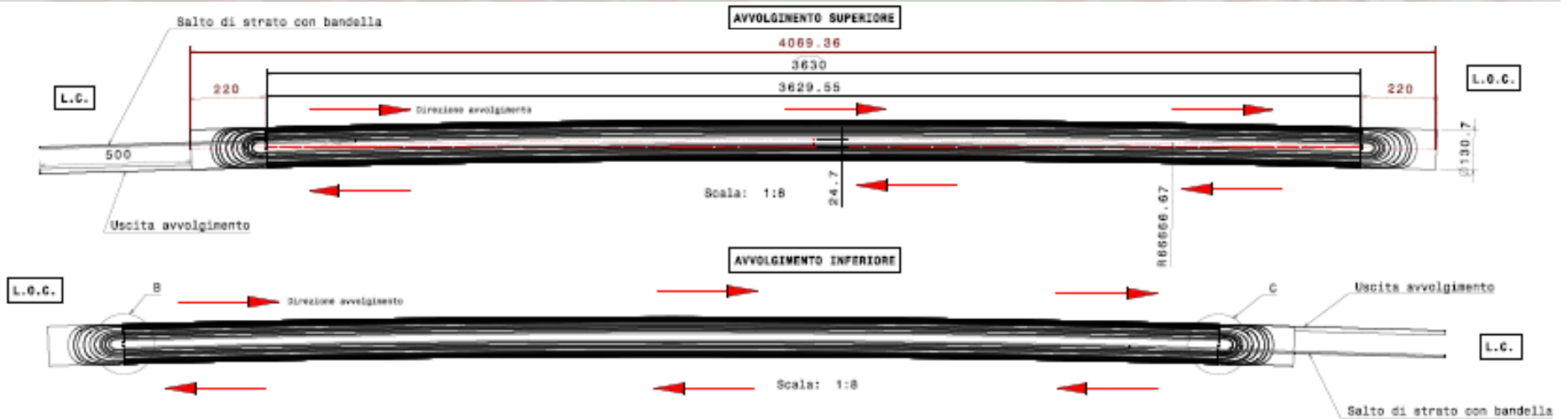

Upper Coil

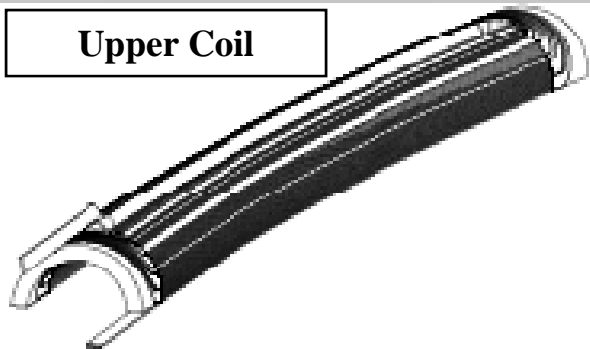

Lower Coil

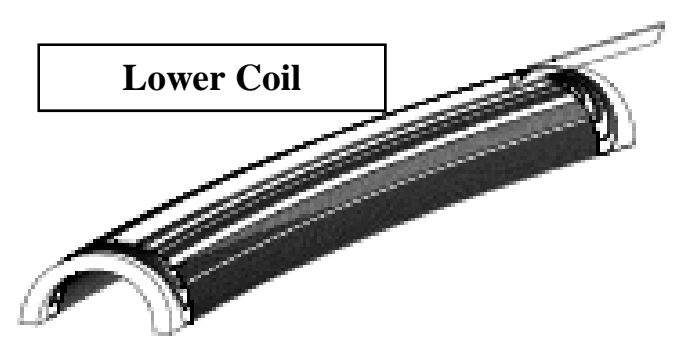

COIL WINDING

Winding Test

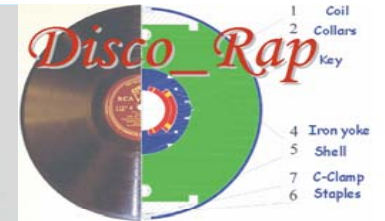

- Coil Ends Details-



Opposite Connection Side

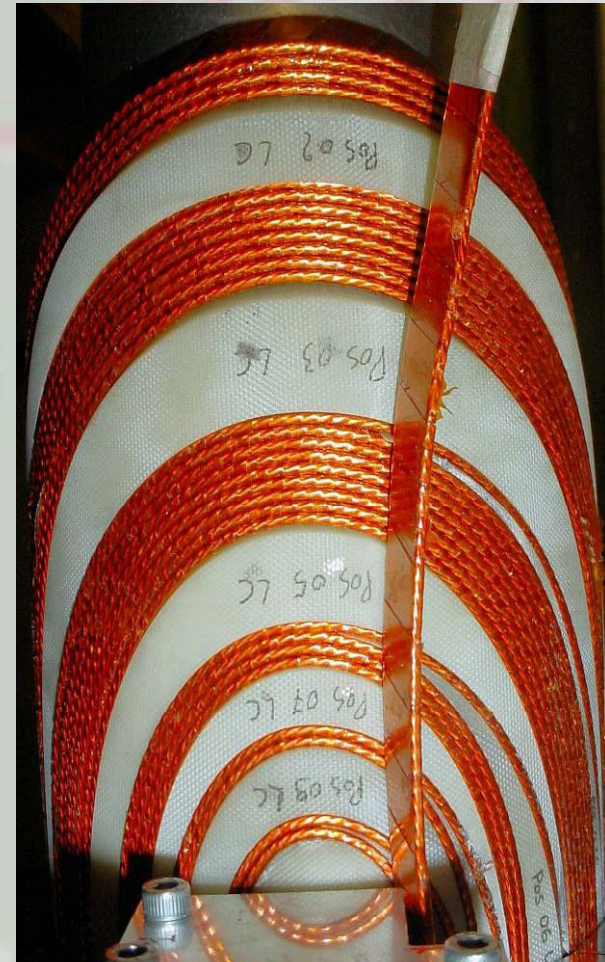

Connection Side

COIL CURING

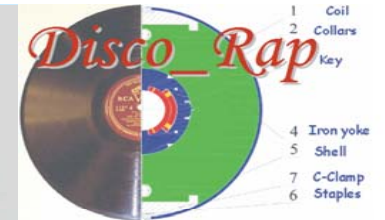

<p>Curing Tool System Dimensional Tolerance</p>	<p>Within 0.05 mm along coil length</p>
<p>Curing Force</p>	<p>Fmax : 250 ton/m equivalent to 75 0/+5 MPa Average Azimuthal Stress</p>
<p>Curing Temperature & Pressure Scenario</p>	<p>LHC Main Dipoles: Coil Sizing @135 °C Coil Curing @185 0/+5 °C</p>

COLLARED COILS ASSEMBLY

POLE ASSEMBLY

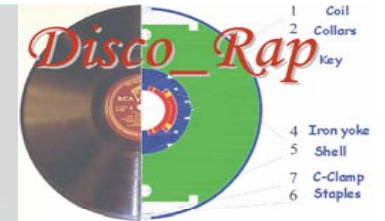

- **The Upper & Lower Coils are Assembled Around the Beam Tube.**
- **To Ease the Assembly of the Components as : quench heaters, cooling channels, ground insulation, an Appropriate Support Structure Able to Rotate the Coils in then Used.**

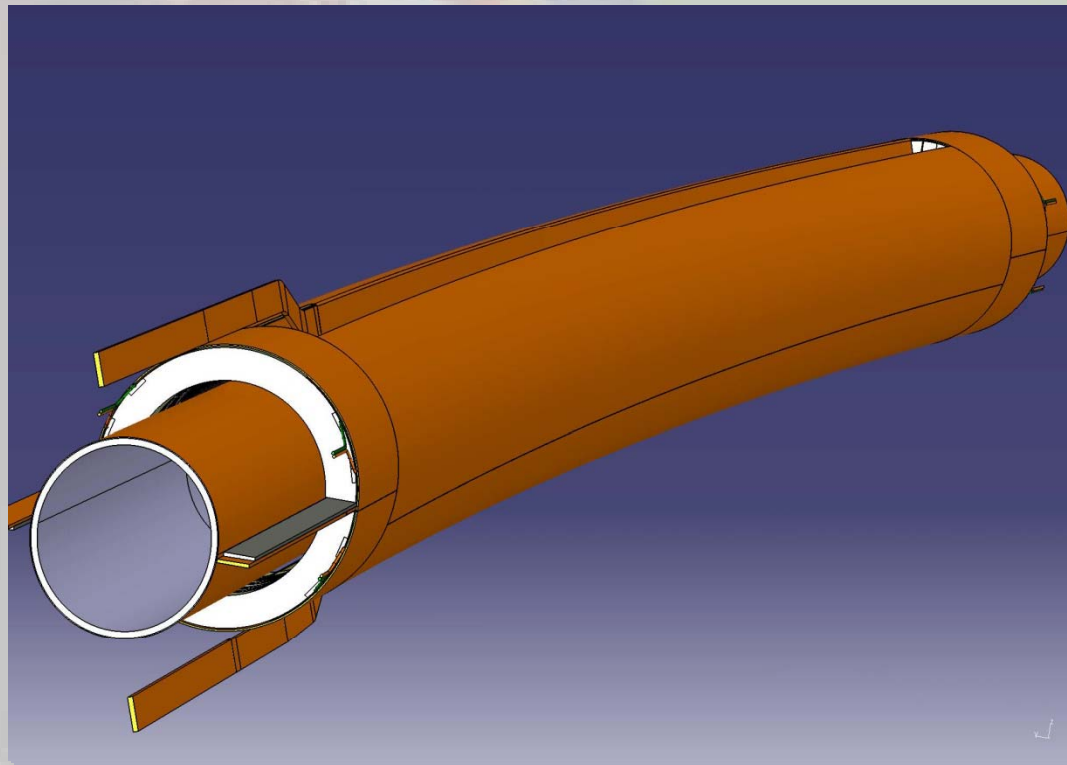

COLLARED COILS ASSEMBLY

Quench Heaters

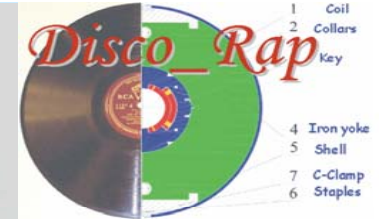

- **No.8 Heating Strips (two each coil side) are in Contact with Outer Radius**
- **Same Technology & Lay-out as Developed for LHC Main Dipoles**

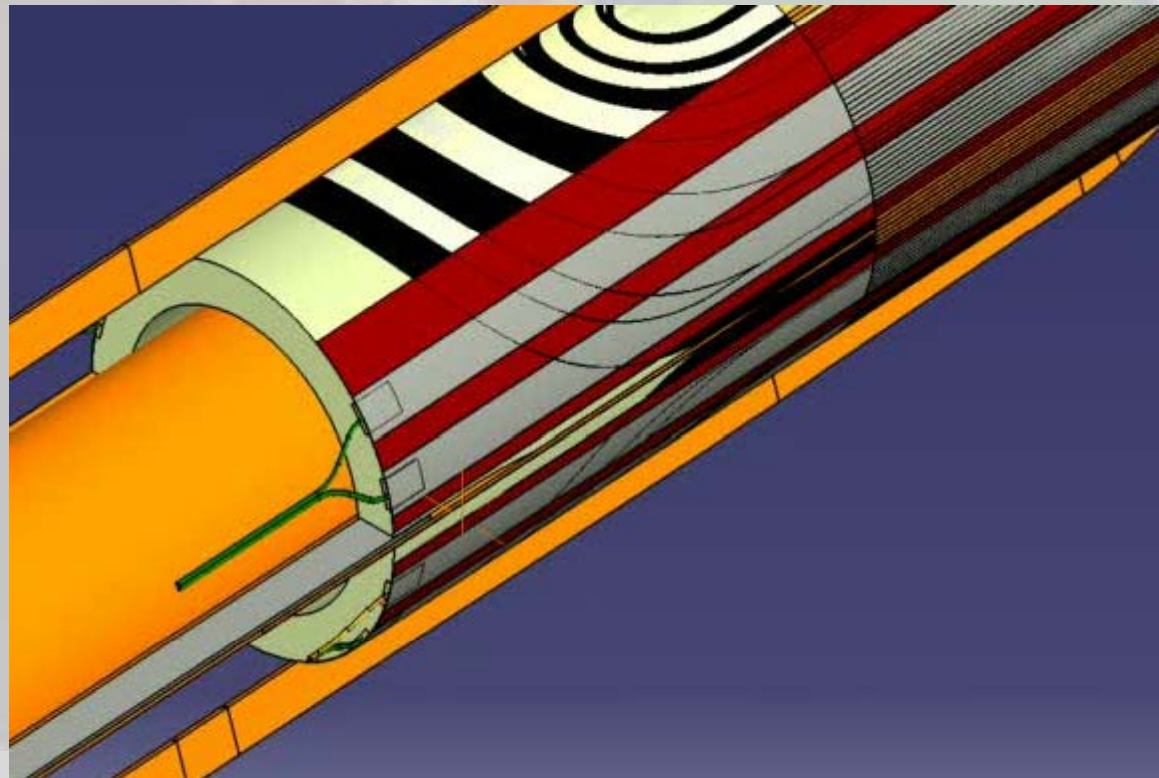

COLLARED COILS ASSEMBLY

Cooling Channels

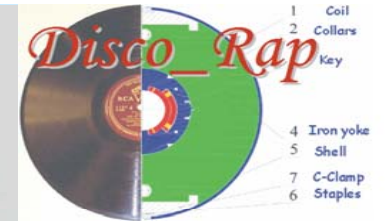

- **Over the Quench Heaters, ULTEM or G11 100 mm long Machined Sheets are Positioned**
- **Same Technology Developed for LHC Main Dipoles**



COLLARED COILS ASSEMBLY

Ground Insulation & Coil Protection Sheets

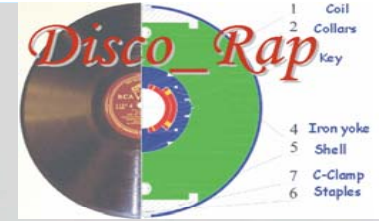

**Ground insulation:
Four 125 micron
Polyimide Sheets
Placed Around the
Cooling Channels**

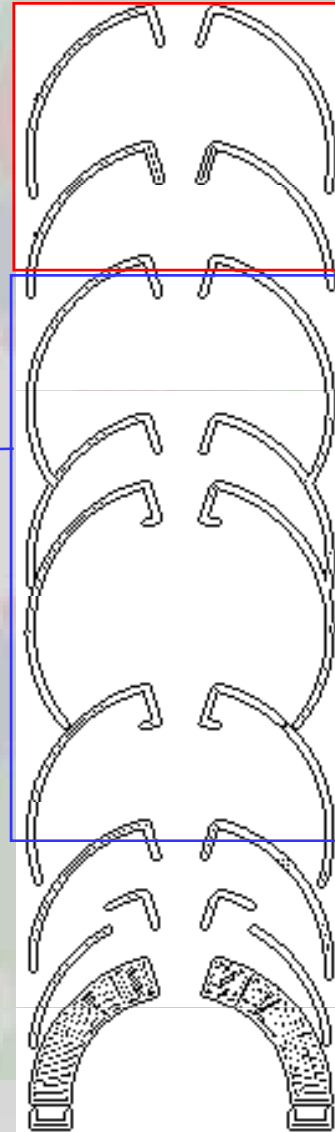

**An Additional
Couple of
“Sacrifice” 125
micron Polyimide
Sheets is Used to
Protect the
Ground Insulation
During Collaring**

COLLARED COILS ASSEMBLY

Ground Insulation & Coil Protection Sheets

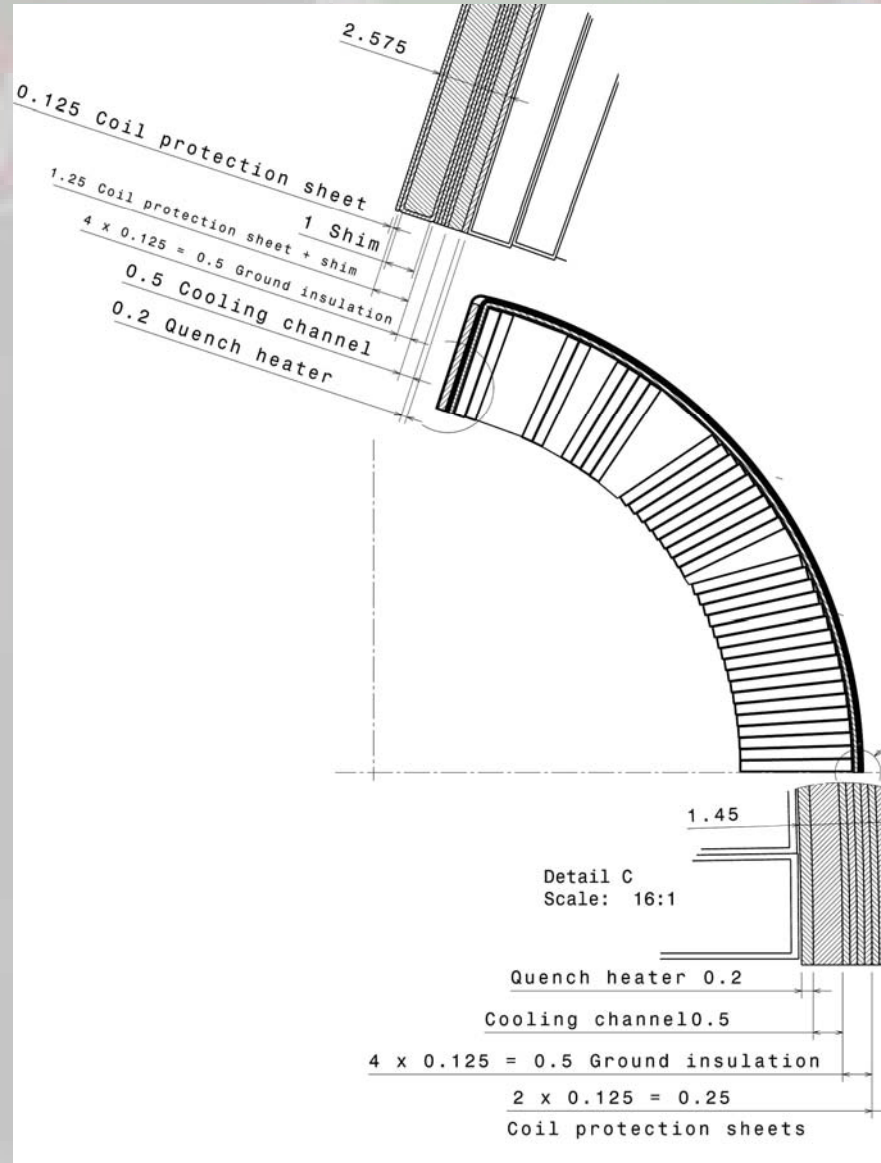
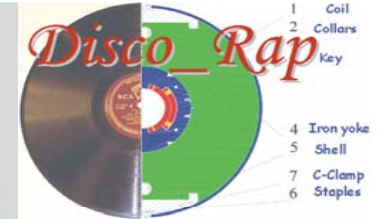

COLLARED COILS ASSEMBLY

Collars

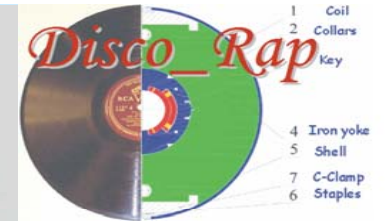

- **NITRONIC 40**
- **3 mm thick**
- **One Side Insulated**
- **Fine Blanked to Get the Best Precision and Reproducibility**

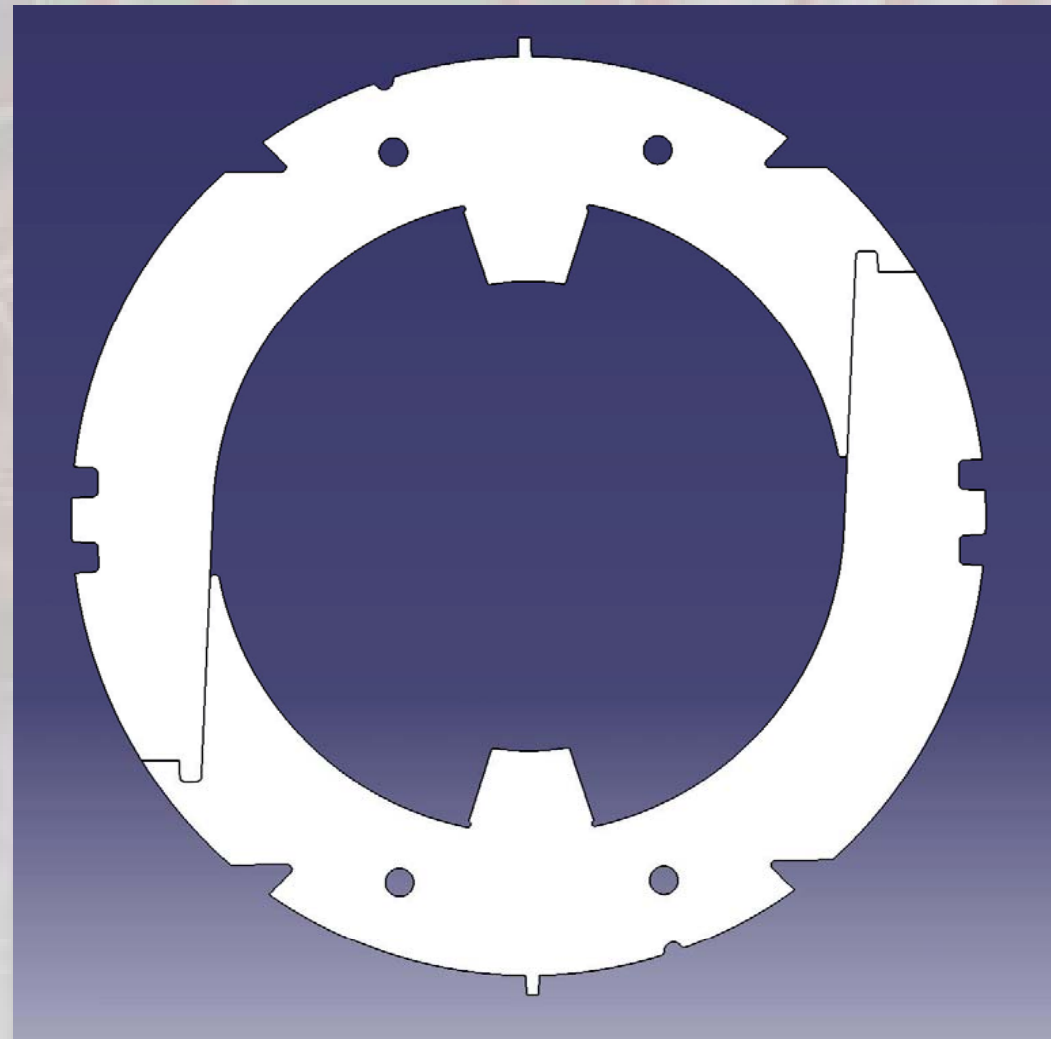

COLLARED COILS ASSEMBLY

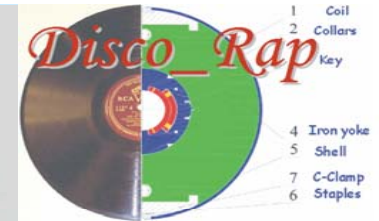

Collar Pack

- **10 Collar Laminations are Stacked and Locked by Shear Pins to Form a 30 mm Collar Pack**
- **To Maintain the Curvature, at One End a Washer 0.09 mm thick on the Pin Hole Convex Side**

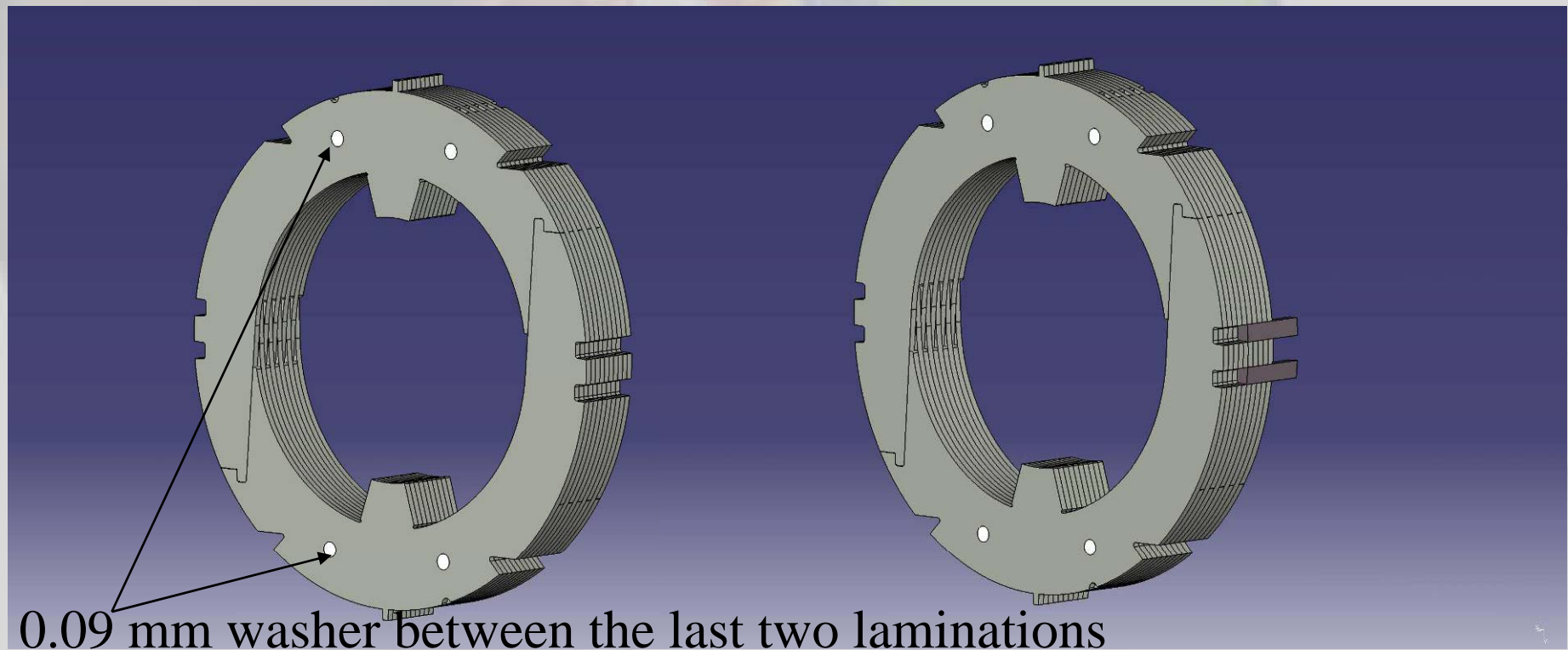

COLLARED COILS ASSEMBLY

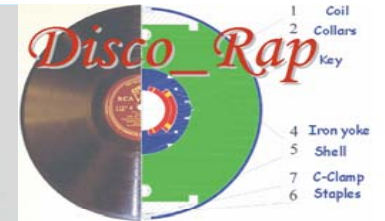

On the Same Assembly Station the Collar Packs are mounted Around the Ground Insulated Pole

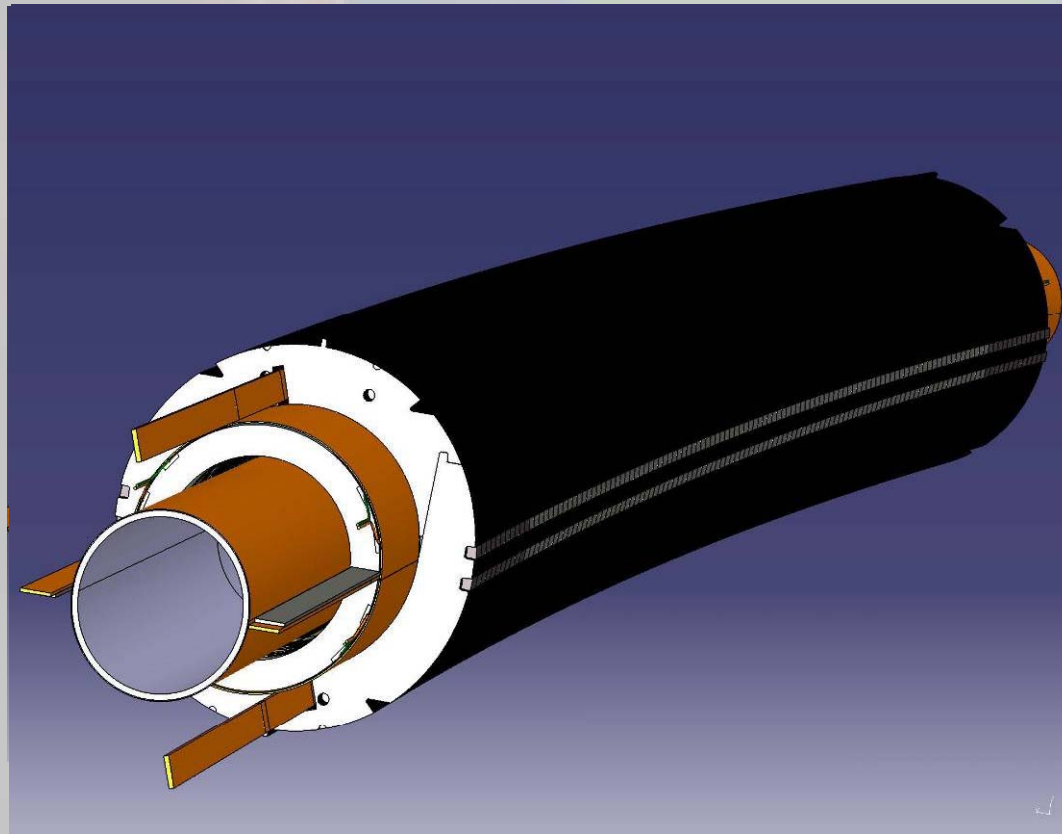

COLLARED COILS ASSEMBLY

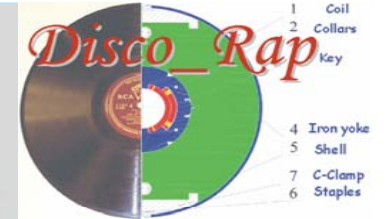

Collaring

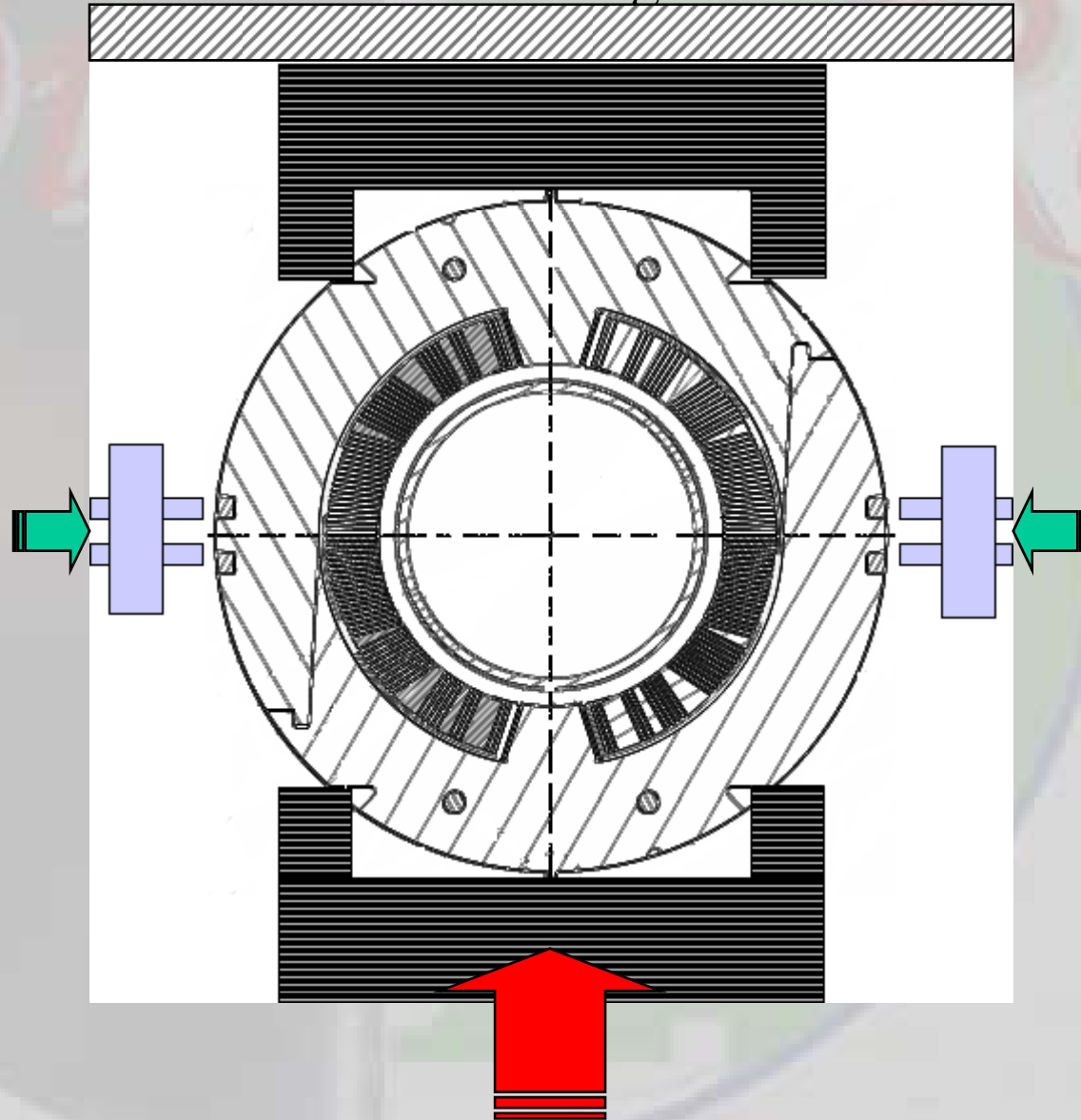

IRON YOKE MANUFACTURING

Half Yoke Lamination

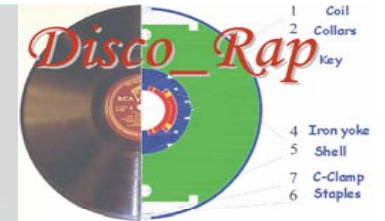

➤ **Fine Blanked Lamination**

➤ **M600-100 A Insulated
Silicon Steel**

➤ **1 mm Thick**

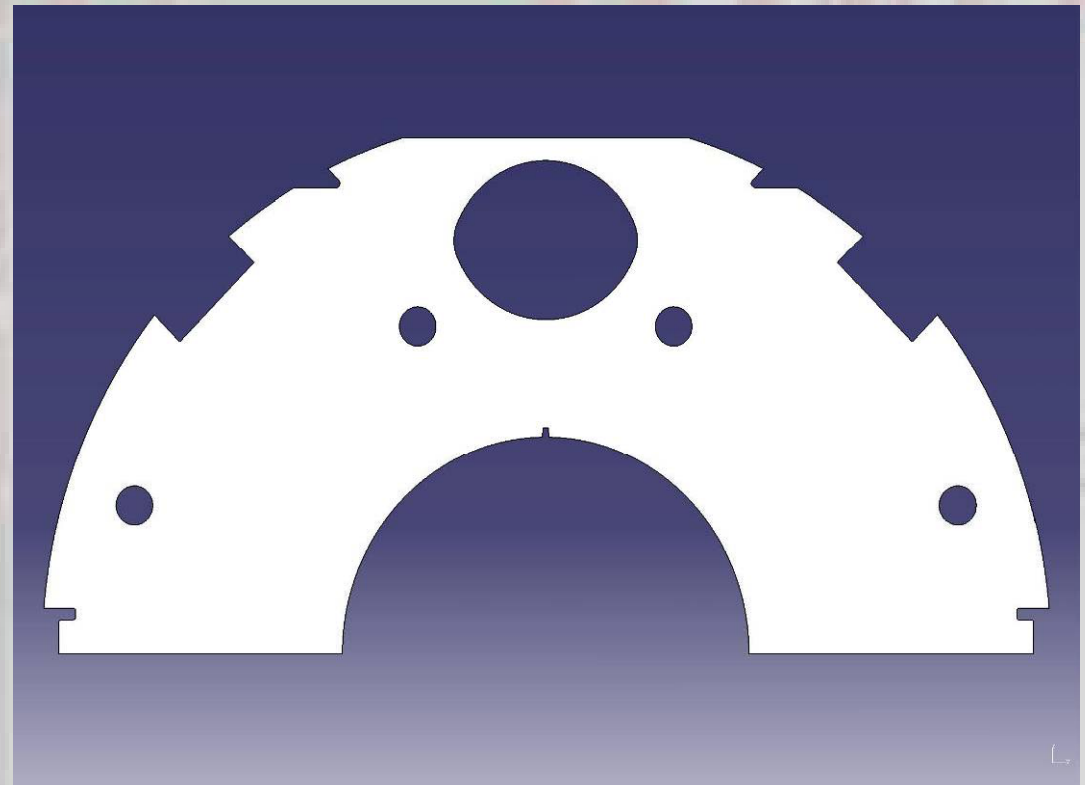

IRON YOKE MANUFACTURING

1 m Half Yoke

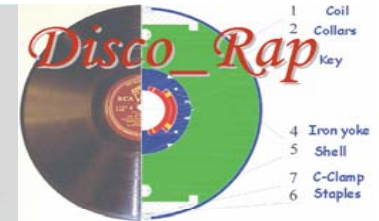

- **Using an Horizontal Press, 1 m Long Half Yoke Laminations are Stacked on a 66.67 m Curved Reference Profile and then Pressed to nominal Stacking Factor.**
- **5 mm Thick Flanges Obtained by Glued Laminations are Used as End Flanges.**
- **During Laminations Stacking four Stainless Steel Curved Pipes are Inserted inside Half Yoke**
- **Once Obtained the Nominal Stacking Factor and Ends planarity/perpendicularity the Pipes Ends are Deformed to Lock the Half Yoke in Position**

IRON YOKE MANUFACTURING

Half Yoke Assembly

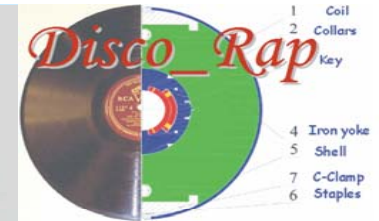

- **The 1 m Half Yokes are Transferred to an Assembly Bench and Aligned on a 66.67 m Curved Reference**
- **During Assembly, Four Insulated Stainless Steel Tie Rods are Inserted in the Half Yokes**
- **Tie Rods are then Tightened**

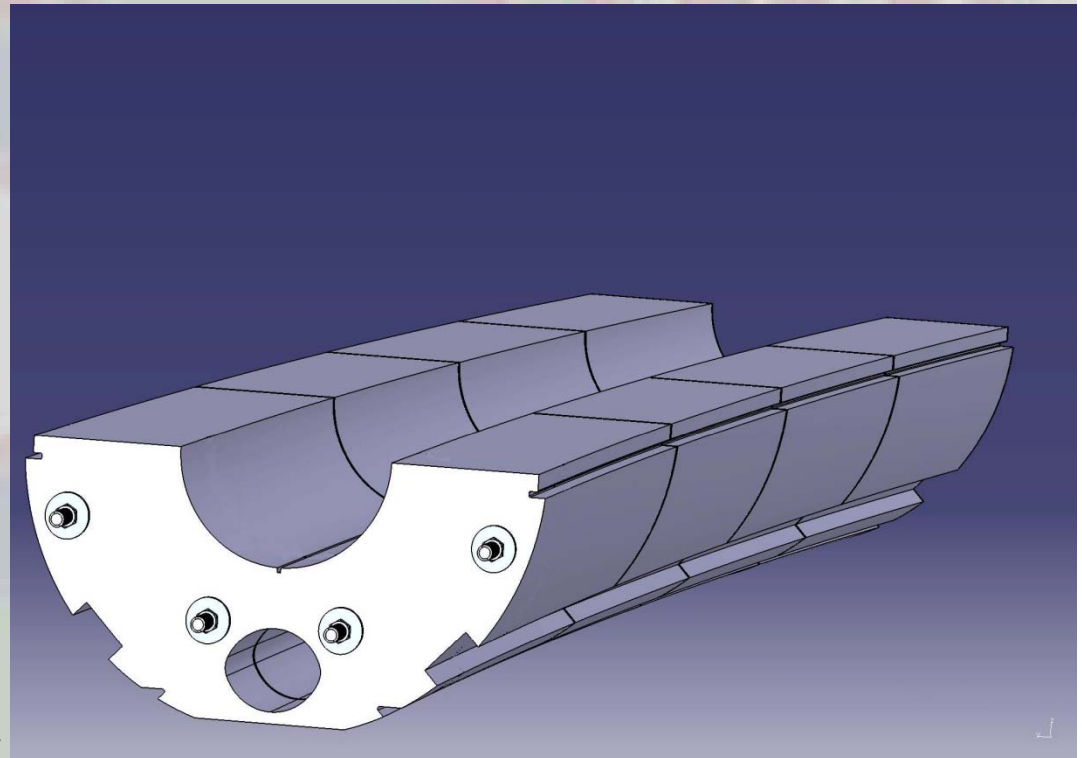

COLD MASS ASSEMBLY

Iron Yoke Clamping

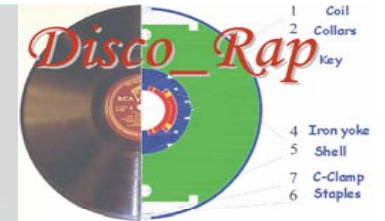

➤ **On the Press Bench
Lower and Upper Half
Yokes are Placed Around
the Collared Coils**

➤ **The so Assembled Yoke
is Introduced by Trolley
Inside the Press**

➤ **C-Clamp are
Introduced in the Yoke
Slots and Pressure
Released**

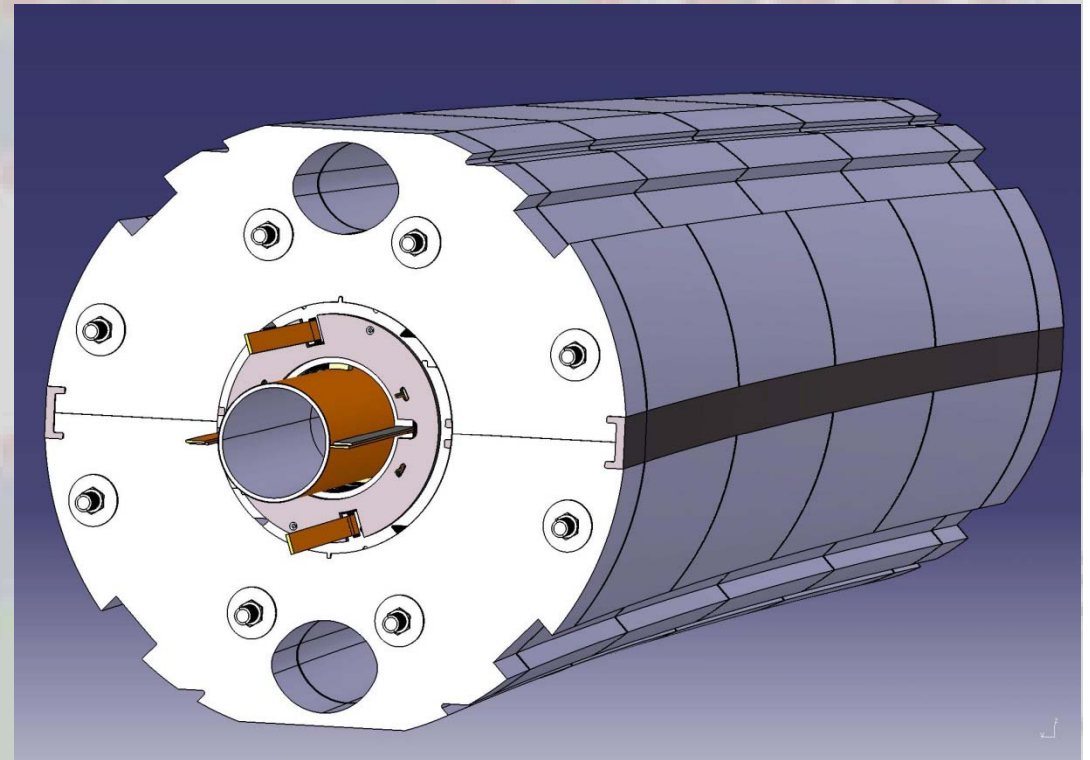

COLD MASS ASSEMBLY

Cold Mass Completion

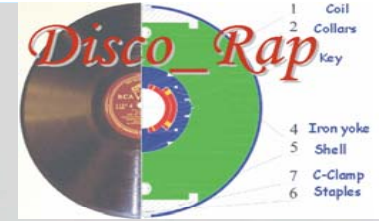

- **C-Clamped Yoke Moved on the Lower Half Shell**
- **Side Flanges Aligned**
- **Upper Half Shell Placed on Yoke**
- **Welding of Side Flanges and Half Shells**
- **Electrical Connections & Axial Coils Pre-Stress**
- **Mounting and Welding of End Covers and Supports**

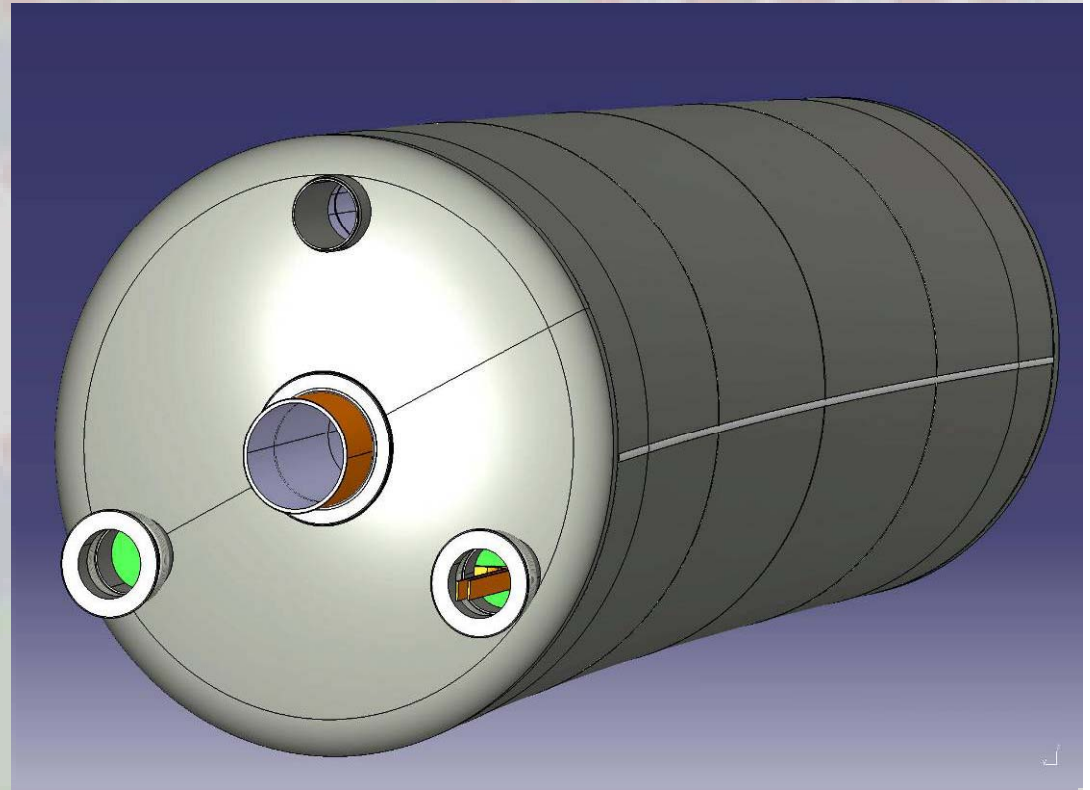

COLD MASS ASSEMBLY

