

THE TECHNICAL DESIGN REVIEW OF THE SUPERCONDUCTING MODEL DIPOLE FOR FAIR SIS300

INTRODUCTORY INFORMATION TO DISCORAP PROJECT (Basic choices)

P.Fabbricatore
INFN Genova

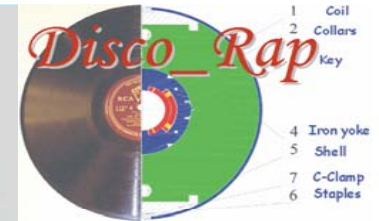

OUR AIM: DESIGNING, BUILDING AND TESTING A MODEL COIL

Characteristics of the model coil.

Nominal field (T) :	4.5
Ramp rate (T/s)	1
Radius of magnet geometrical curvature (m)	66 2/3
Magnetic length (m)	3.879
Bending angle (deg)	3 1/3
Coil aperture (mm)	100
Max temperature of supercritical He (K)	4.7

Also if the model is neither a magnet to be installed in the SIS300 nor a prototype magnet, it contains most of the features and the characteristics of the SIS300 (short) dipoles.

THE TECHNICAL DESIGN REVIEW OF THE SUPERCONDUCTING MODEL DIPOLE FOR FAIR SIS300

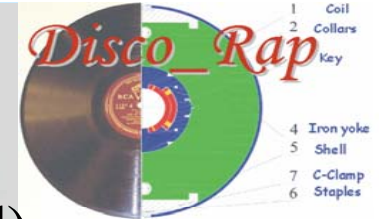

A precedent of curved dipole (not fast cycled)

Development of Curved Superconducting Dipole Magnet for Proton Synchrotron at KEK

T. Shintomi, Y. Mori, H. Sato, T. Toyama and M. Yoshii
National Laboratory for High Energy Physics, Tsukuba, Ibaraki 305, Japan

T. Chiba, M. Saeki, M. Saitoh, Y. Suzuki and R. Tomita
Hitachi Works, Hitachi, Ltd., Hitachi, Ibaraki 317, Japan

TABLE I
PARAMETERS OF DIPOLE MAGNET FOR PS COLLIDER

Magnetic field	(T)	6.06
Effective magnetic length	(m)	1.4
Useful aperture	(mm)	46
Sagitta	(mm)	23
Curvature	(m)	10.7

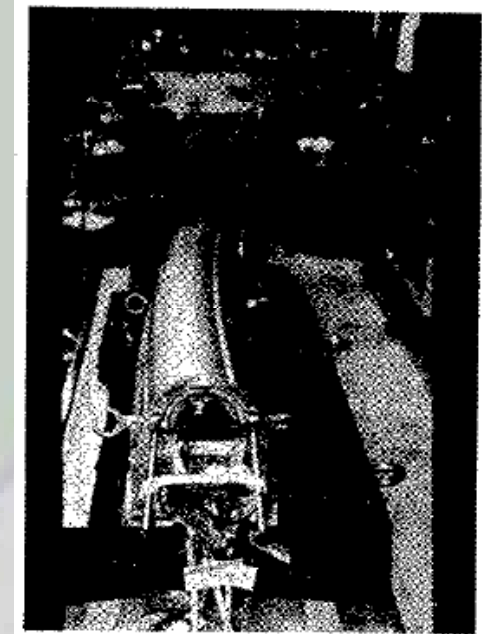
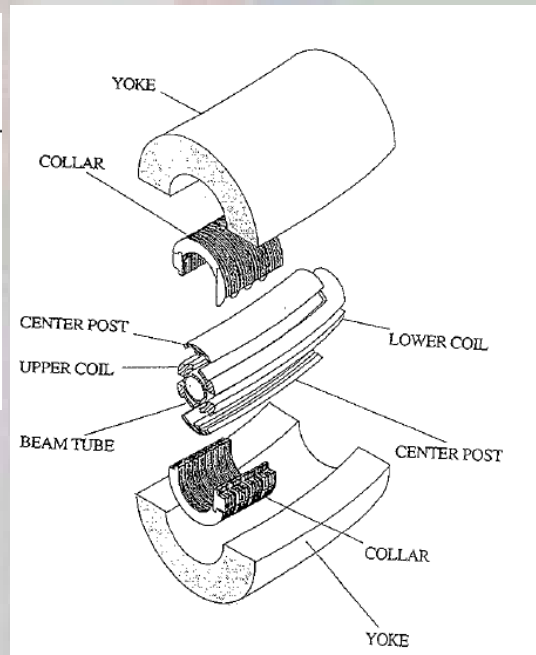

Never tested!!

**THE TECHNICAL DESIGN REVIEW OF THE
SUPERCONDUCTING MODEL DIPOLE FOR FAIR SIS300**

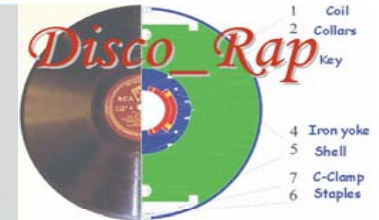

**A precedent of fast cycled dipole
(short straight model)**

Proceedings of 2005 Particle Accelerator Conference, Knoxville, Tennessee

**RECENT TEST RESULTS OF THE FAST-PULSED 4 T COS θ DIPOLE
GSI 001**

Gebhard Moritz[#], Juris Kaugerts, GSI, Darmstadt, Germany

John Escallier, George Ganetis, Animesh Kumar Jain, Andrew Marone, Joseph F. Muratore, Richard Thomas, Peter Wanderer, BNL, Upton, Long Island, New York, U.S.A

Bernhard Auchmann, Riccardo de Maria, Stephan Russenschuck, CERN, Geneva, Switzerland,
Martin Wilson, Consultant, Oxford, Oxon, U.K.

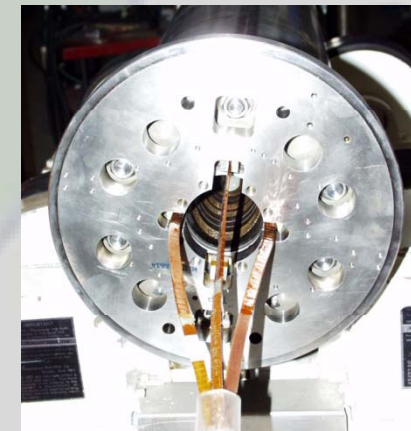
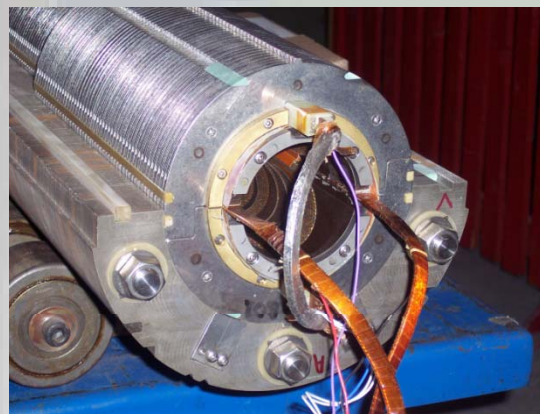
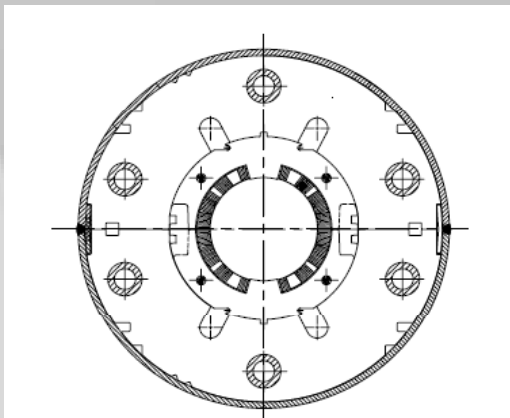

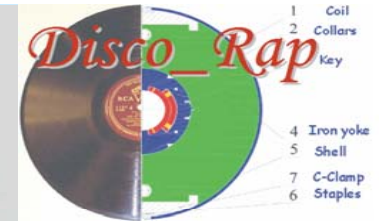

A VERY BASIC CHOICE: Curved winding

The starting assumption for the design was that the coil should be wound curved, because:

- 1) This solution allows defining a curved geometry of the coil with no residual stresses;
- 2) Once cured, the coil can be handled in a simple and safe way for the following manufacturing operations (collaring, insertion in the iron yoke, ...).

The main body of the coil is curved. The ends are straight

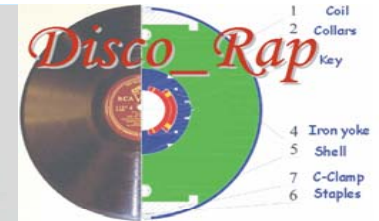

1) Straight winding → Bending → Curing

We have not found any satisfactory methods for bending an uncured winding on its mandrel

2) Straight winding → Curing → Bending

$\Delta R/R = 9.8 \cdot 10^{-4} \leftrightarrow$ from -15 MPa to +15 MPa permanent stress in the winding (Spring back effect). Not clear handling of this curved object (with not well defined deformed shape) during collaring operation.

3) Curved winding → Curing

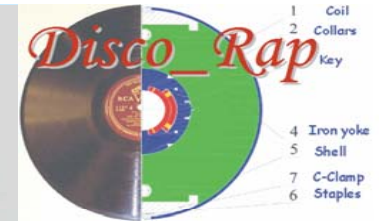

One layer coil

- The choice of a curved winding naturally oriented the design to a single layer coil mechanically supported only by the collars.
- The mechanical coupling between two curved layers or between a curved collared coil and a curved yoke appeared to be critical operations, which could be faced only once the simplest curved layout (single collared layer) had been deeply investigated.

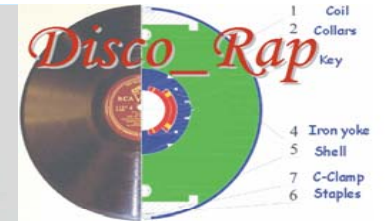

Magnet layout

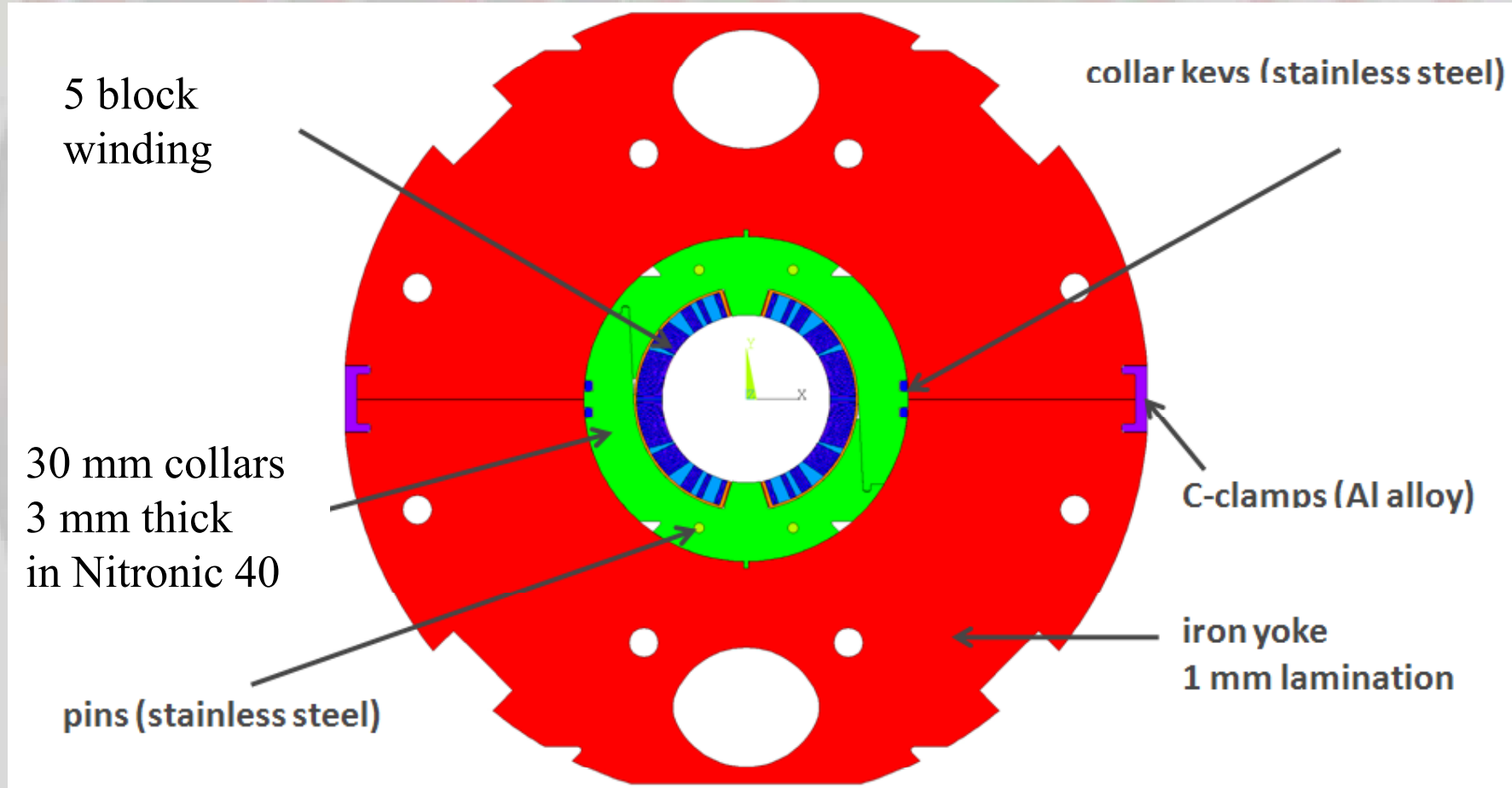

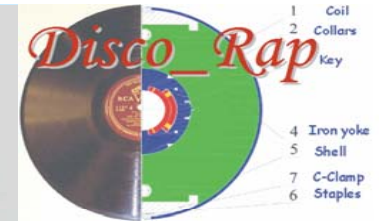

Mechanical role of the iron yoke: limiting deformations

- The winding is mechanically supported by 30 mm wide collars of high strength austenitic steel and is pre-stressed at 70 MPa at room temperature.
- The magnetic forces are not significantly large to require a mechanical role of the yoke.
- Nevertheless, the iron yoke must have a role in limiting the mechanical deformations of the collared coil for avoiding fatigue failures in some locations. (10^7 cycles)

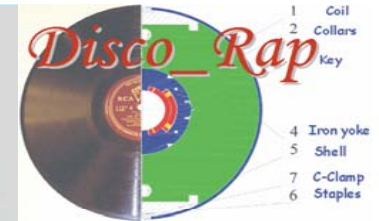

A cored conductor

The conductor is based on a cored Rutherford cable with 36 strands (similar to the LHC dipole outer layer)

This conductor is characterized by several features, chosen to provide low ac losses:

- 1) The filaments are small (down to 2.5 mm);
- 2) The matrix surrounding the filaments is made of CuMn;
- 3) The cable is cored using a thin stainless steel foil (25 mm) for cutting down the inter-strand coupling currents

THE TECHNICAL DESIGN REVIEW OF THE SUPERCONDUCTING MODEL DIPOLE FOR FAIR SIS300

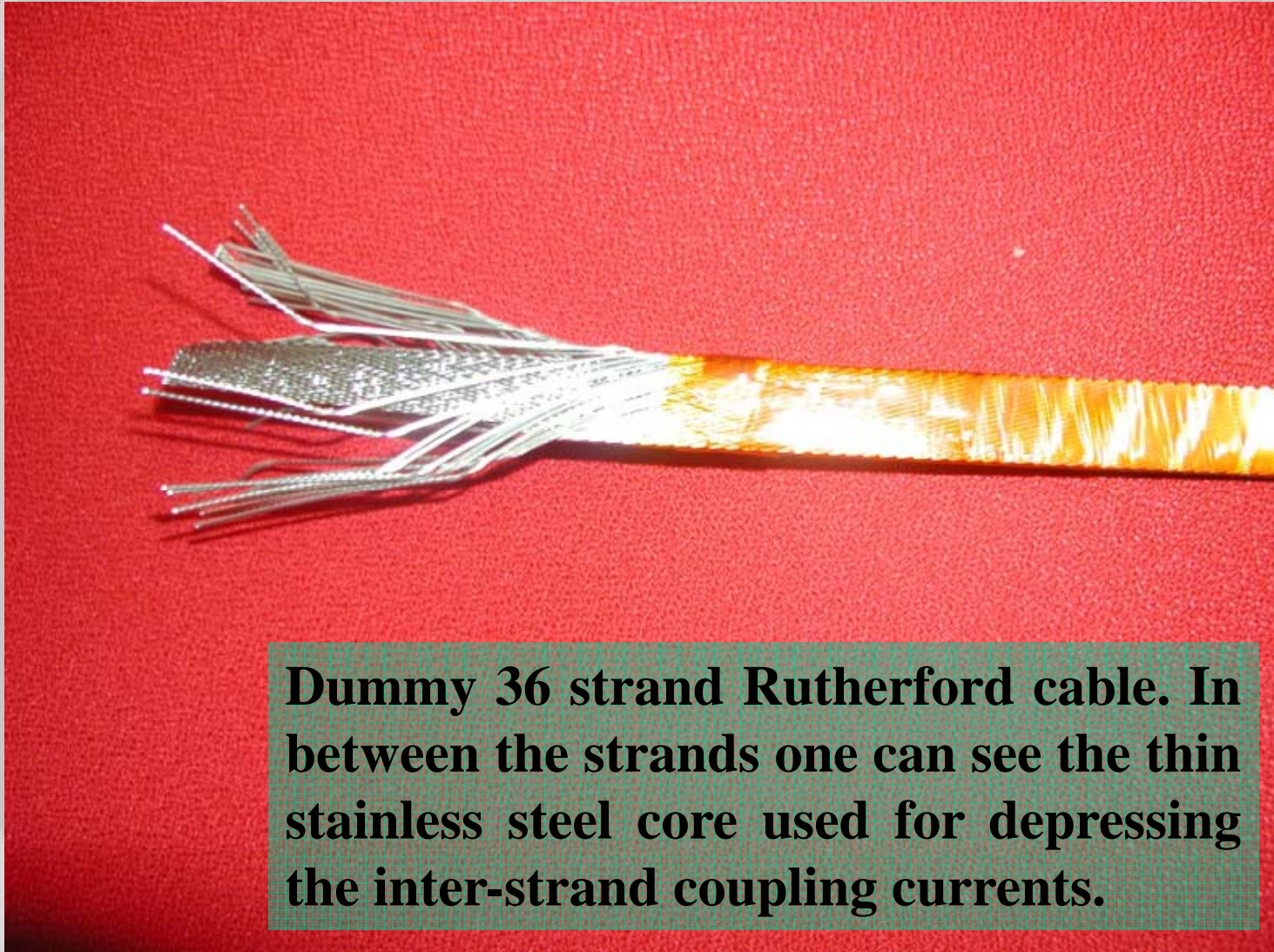
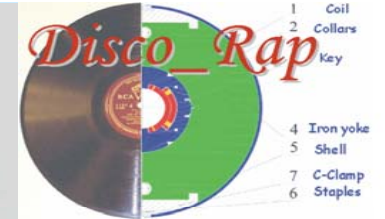

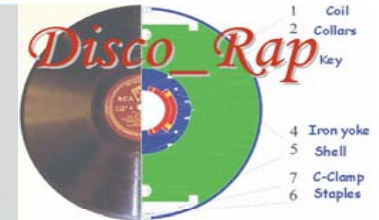

INDUSTRIAL R&D

The stainless steel core makes the conductor stiffer than a standard Rutherford cable, both causing more difficult winding operations and adding complexities to the already difficult curved winding. For this reason we launched, in parallel to the design, an industrial R&D, aimed at developing the winding techniques of a cored cable for a curved coil.

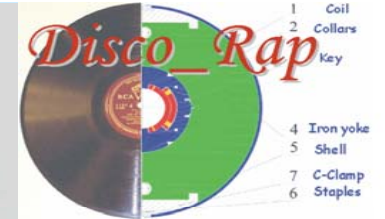

Parallel developments

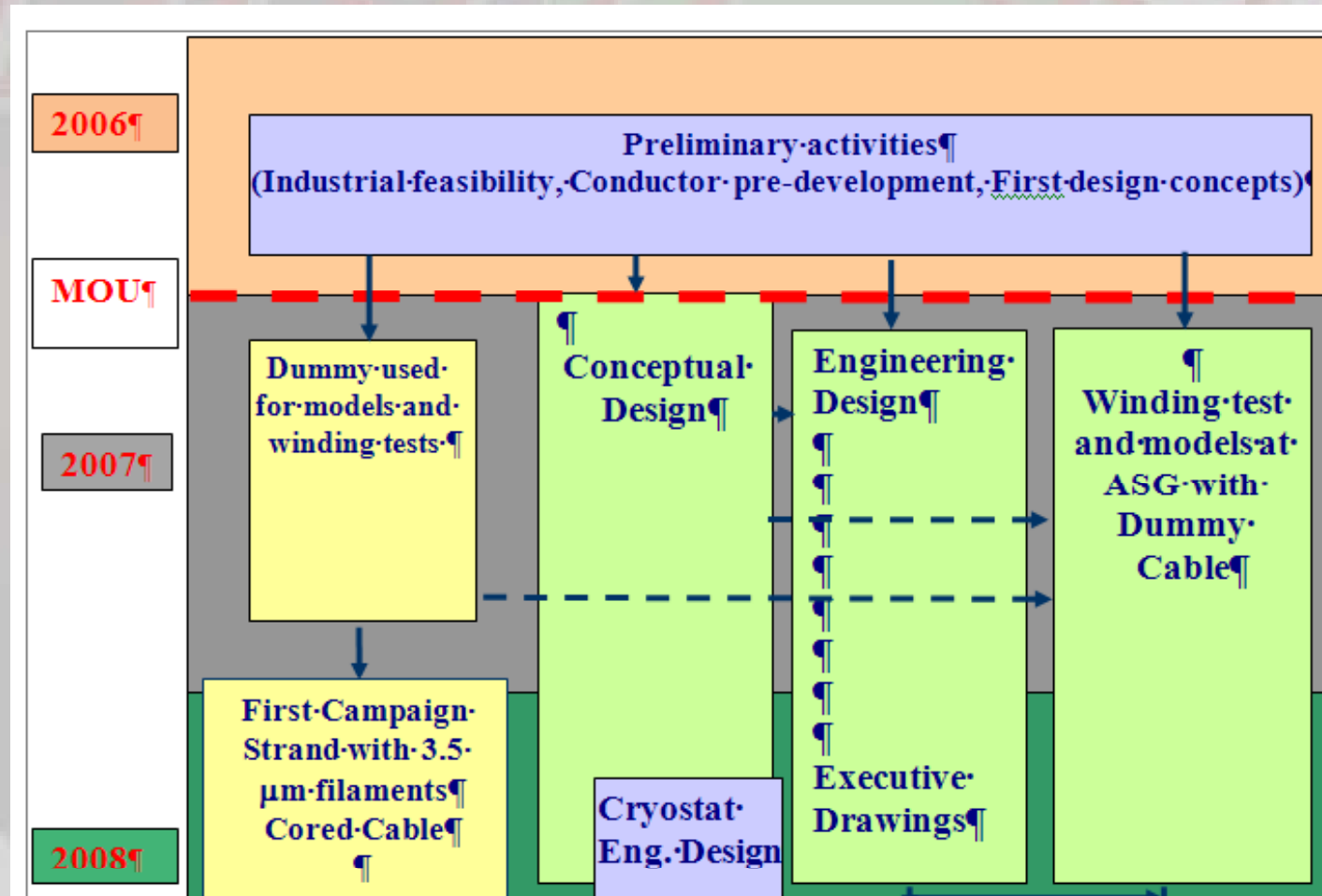

THE TECHNICAL DESIGN REVIEW OF THE SUPERCONDUCTING MODEL DIPOLE FOR FAIR SIS300

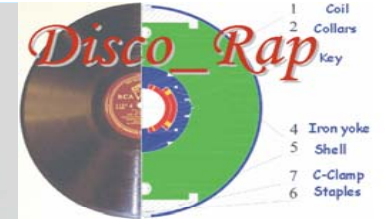

This activity held place at ASG Superconductors in Genova, under an INFN contract. A special winding machine was developed for winding a cored Rutherford cable on a curved mandrel.

Several winding tests were performed using first the LHC dipole outer layer

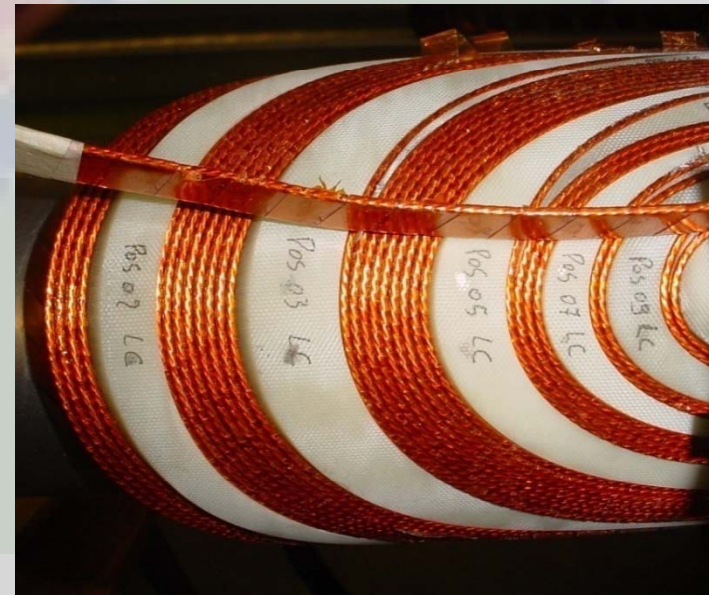

THE TECHNICAL DESIGN REVIEW OF THE SUPERCONDUCTING MODEL DIPOLE FOR FAIR SIS300

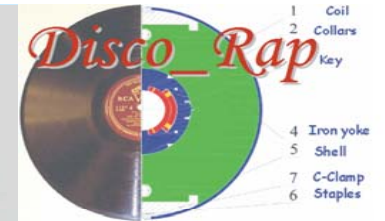

In a second step, the tests were carried out using the trial winding cored cable obtained by cabling the LHC dipole wire with a stainless steel insert .

An important milestone was then achieved with the successfully completion of a complete pole, proving the developed winding technology.

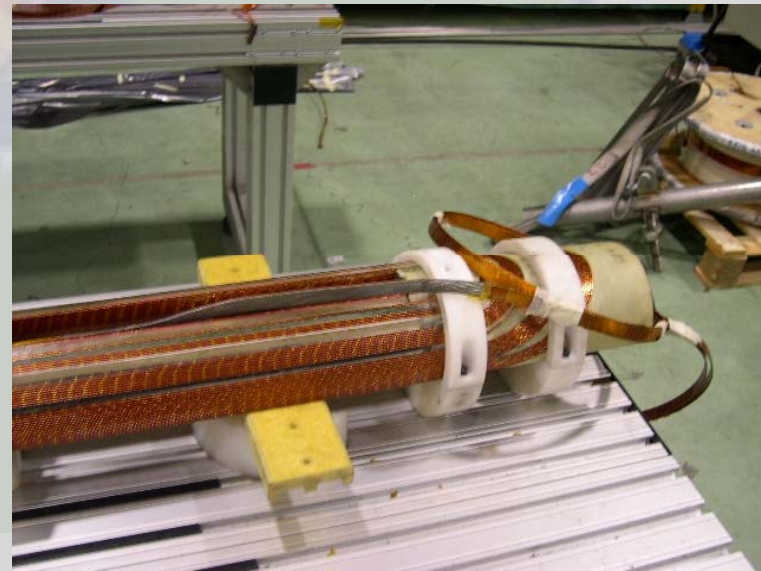

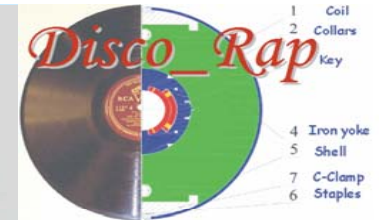

Materials: spacers

The coil wedges and the end spacers are in G11, in order to cut down the eddy currents during the ramps.

Ceramic materials considered too hard and brittle.

Stainless steel can be taken into consideration but the elastic modulus of the stainless steel (200 GPa) is much higher than the modulus of the winding (11 MPa). This difference would cause the winding to be an inhomogeneous mechanical component and make easy the generation of concentrated stress in the conductors

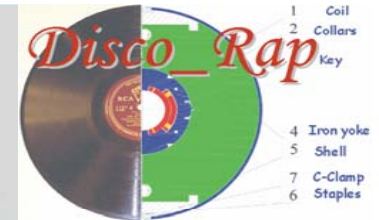

Materials: collars

The collar material was chosen on the basis of the required mechanical and magnetic properties. The stress level demands for a high strength material, mainly in view of the fatigue load.

Low relative magnetic permeability (<1.003) allows to keep the field quality perturbation at the level of 0.1 units in the field region from 0.5 T (stretcher mode) to 4.5 T.

Among Mn SS we selected the Nitronic 40, which has a yield stress $R_{0.2}$ ranging from 700 MPa at room temperature up to 1400 MPa at 4.2 K.

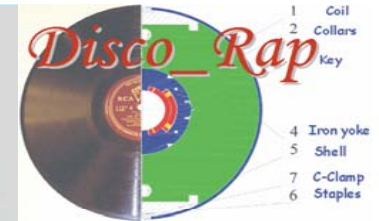

Materials: insulations

The cable insulation is made of three polyimide layers forming a total half-thickness of 125 μm . Since the cooling of the coil is done through supercritical helium in contact with the coil inner wall, the temperature of the cable is greatly determined by the balance between the heat dissipation and the heat removal through this thin insulation layer.

Computations and measurements showed that this choice is acceptable

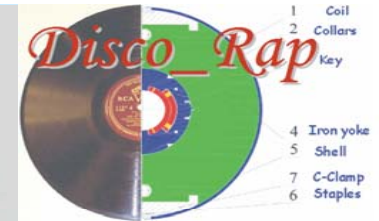

Materials: iron lamination

We verified that at the used ramp rates the main contribution to the losses is coming from the magnetic hysteresis, so we looked for silicon steel having a coercitive field as low as possible. Since the coercitive field is a decreasing function of the Si content, one would use a high Si alloy.

Unfortunately also the brittleness is increasing with the Si content. A good compromise was found for a Si content of $\sim 3\%$ giving a coercitive field of 35 A/m. We identified the commercial lamination M600-100A, according the EN 10106 code.

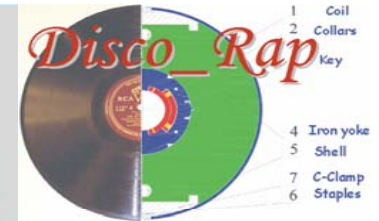

Field Quality

In the present design the field quality is not optimised... but we have a clear idea of the expected field harmonics.

Starting from geometrical harmonics many effects are present: mechanical, dynamic, iron saturation,..

We want to check our capability in evaluating each contribution (by comparing measured with expected values) with the aim to optimize the design

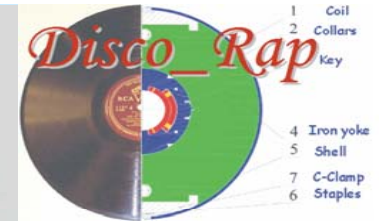

Our design strategy

The presentations to be given today will go in the details of the specific design aspects, which are based on the points I showed.

Other choices were of course possible, but we considered fundamental to define a credible design, build the model and test is as soon as possible, rather than try to optimize a design before constructing something.

Any developments can only be based on verified (or not verified) hypotheses.