



CMS Magnet Commissioning



D.E. Campi, B. Curé, A. Gaddi, H. Gerwig, A. Hervé, V. Klyukhin, G. Maire, G. Perinic, CERN Geneva CH;

P. Bredy, P. Fazilleau, F. Kircher, B. Levesy, CEA Saclay F;

P. Fabbricatore, S. Farinon, M. Greco, R. Musenich, INFN Genova I

- Short remind of design and construction
- Final integration at SX5
- Organization of the magnet surface test
- Preliminary results





CMS is one of the two large experiments at the LHC at CERN

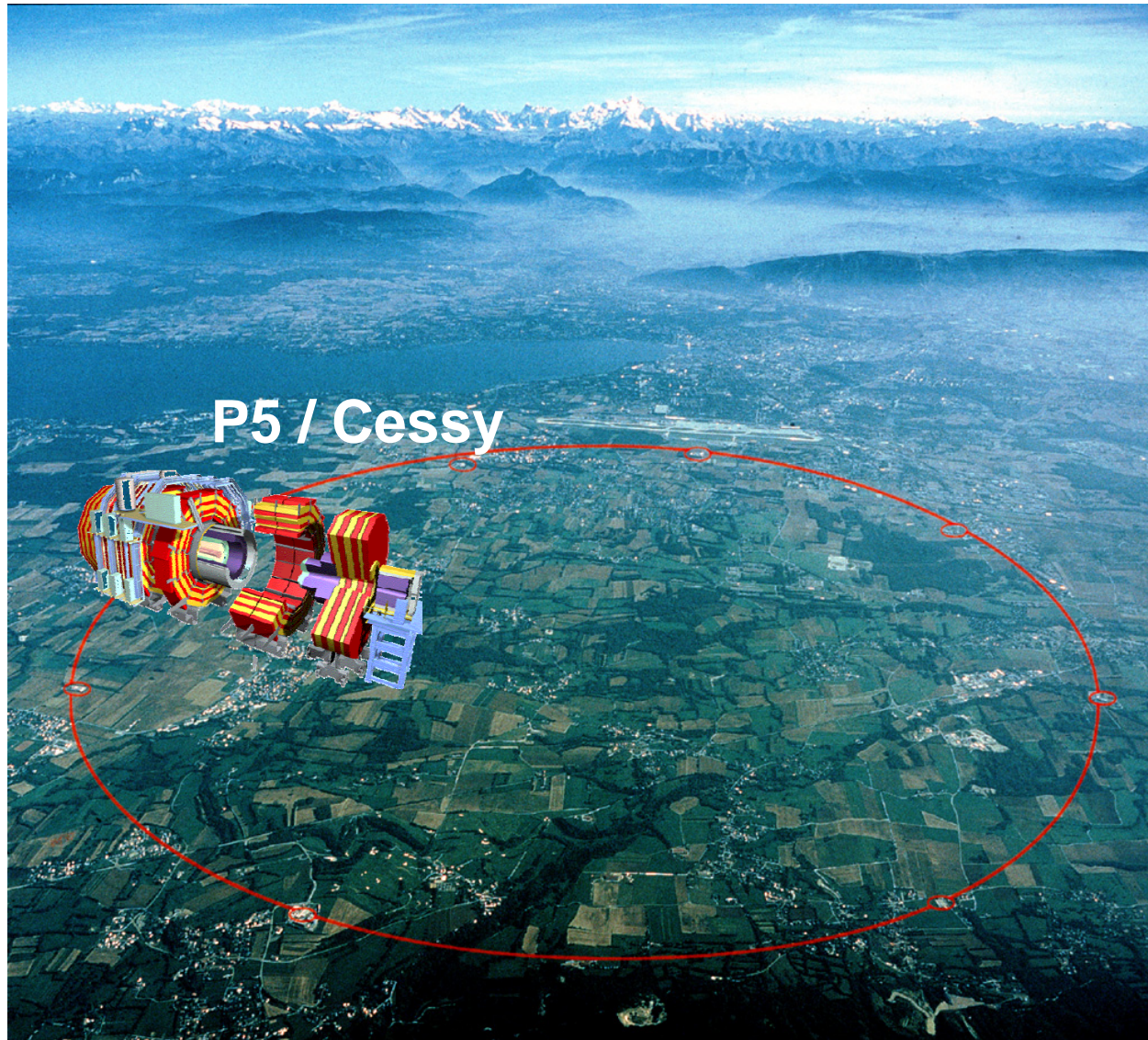



CMS is a general purpose LHC detector based on a solenoidal magnetic field of 4T in a 6m diameter free bore

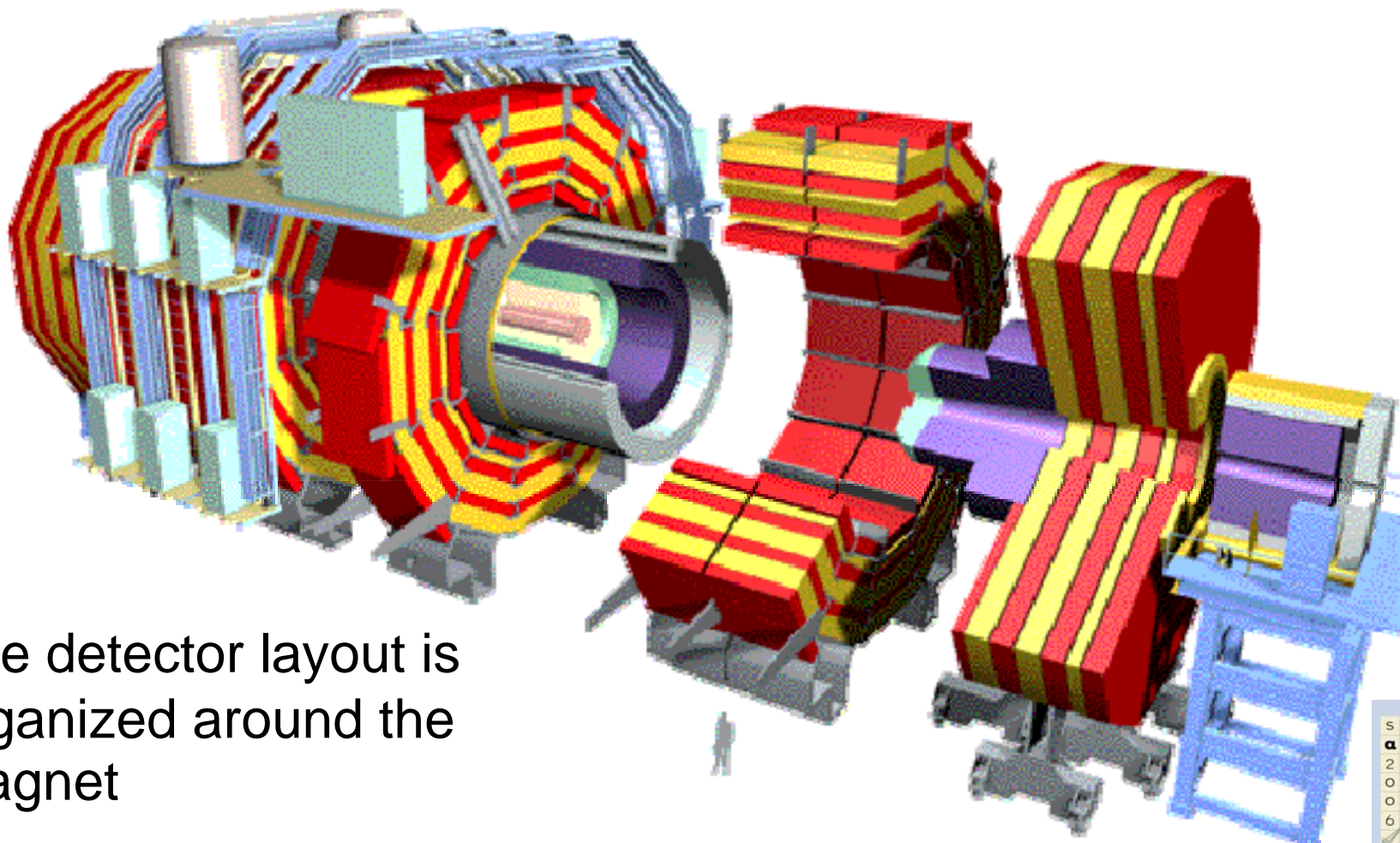

The detector layout is organized around the Magnet





The CMS Magnet Project



CMS is an international collaboration made of more than 2000 scientists from 150 Institutes and the Magnet is a Common Project

The Main Participating Institutes to the Magnet Project have been

- CEA / Saclay : engineering and integration
- ETHZ / Zurich : Conductor
- INFN / Genova : Winding
- Fermilab : Strand procurement and Field Mapping
- University of Wisconsin : End Cap Yoke construction
- CERN : Barrel Yoke, External Cryogenics, Control, and Project Coordination





Construction of the Yoke 1998 - 2002



Pre-assembly at Deggendorf (1999)

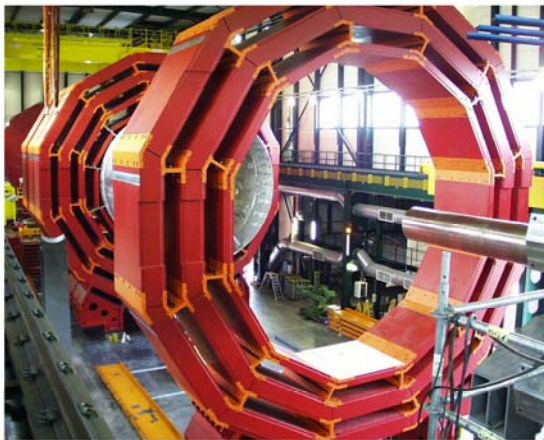

Extraction of YB+2 from the Ferris wheel assembly tooling (2001)

Final assembly at CERN





The Yoke has been completed in 2003 to be ready to accept the cold mass and the muon chambers

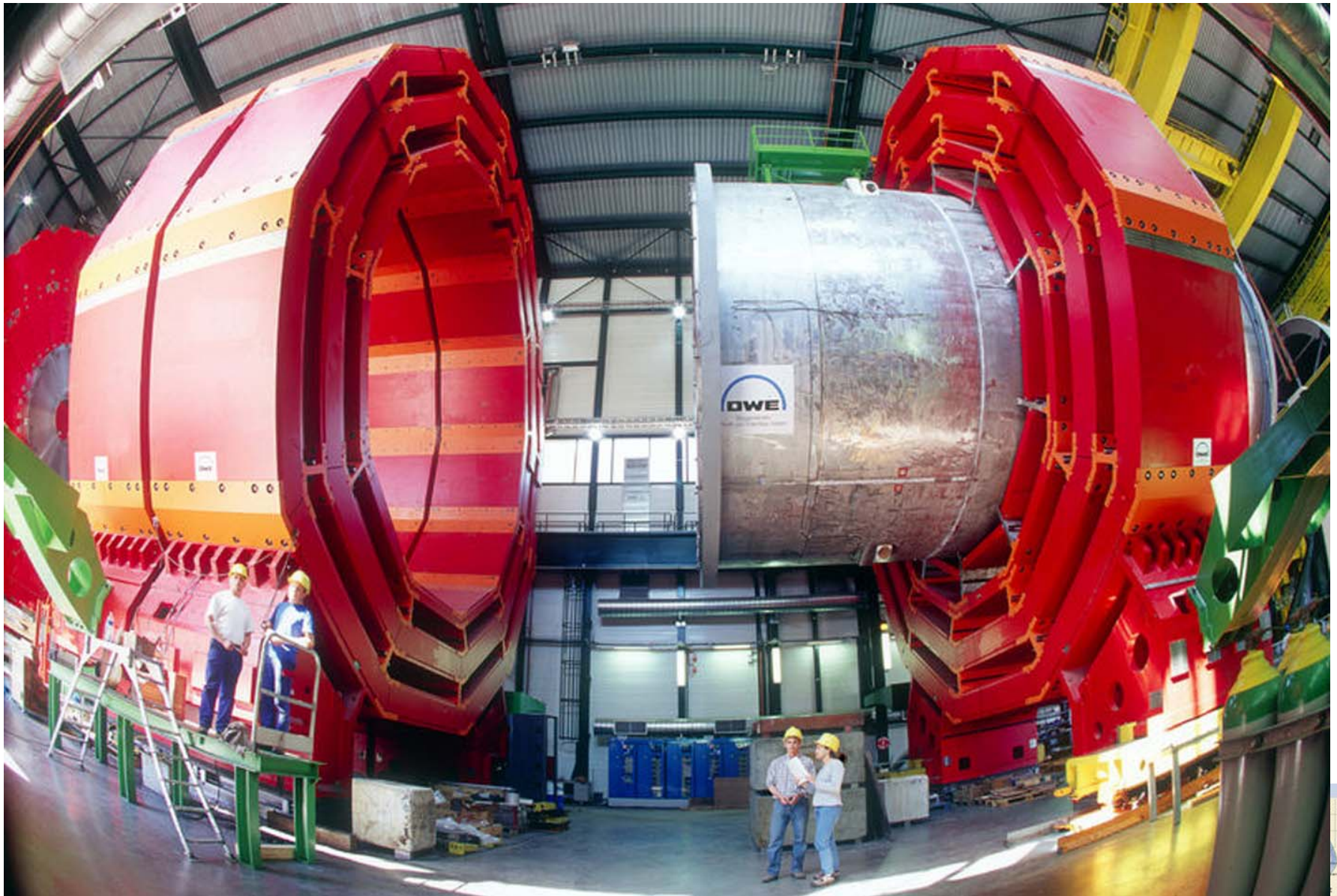



Cold Mass

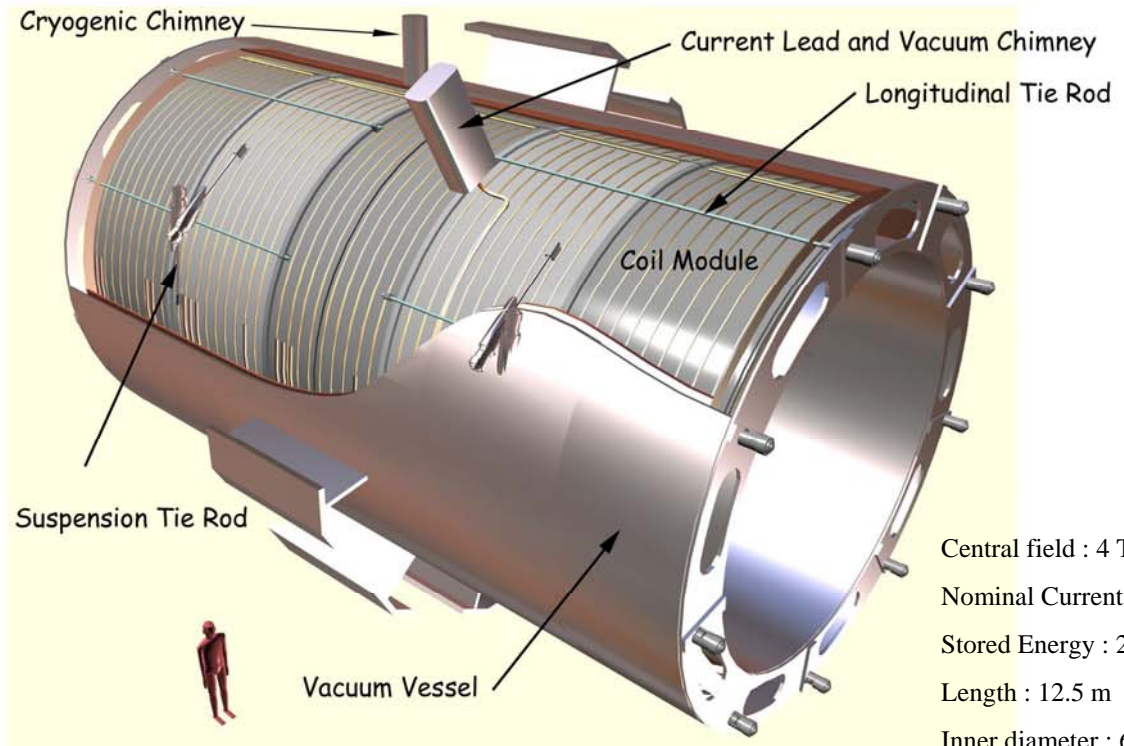

Central field : 4 T
Nominal Current : 19.5 kA
Stored Energy : 2.7 GJ
Length : 12.5 m
Inner diameter : 6 m
Weight : 220 t

Solenoid Cross Section

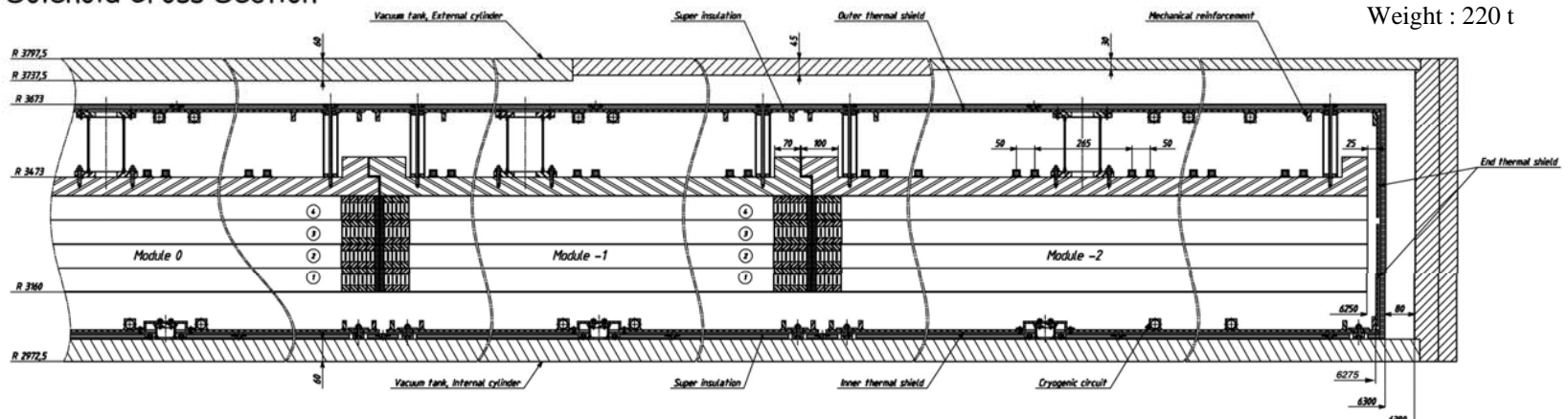



Key features of the CMS Coil



- Reinforced and Al stabilized NbTi conductor
- 4 Layers
- Indirectly cooled at 4.5 K by double thermo siphon circuits
- Inner winding in epoxy resin
- 5 modules





Characteristics of CMS Magnet

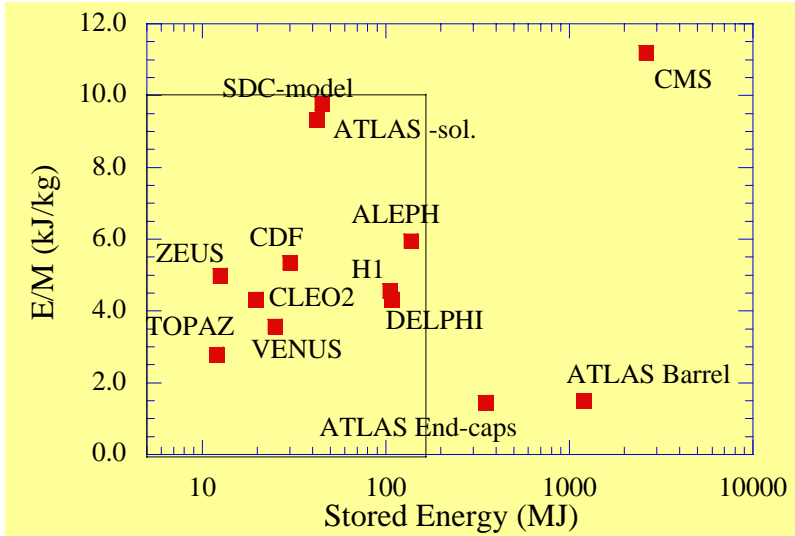

Magnetic field at center 4 T
Nominal current 19120 A
Stored Energy 2500 MJ
Peak field at conductor 4.6T
Coil Length 12.5 m
Coil made of 5 modules with length 2.5 m
Inner Diameter 6320 mm
Outer Diameter 6950 mm
Each module is made of 4 layers
Required conductor length 4 x 2400 m
Module Weight = 4 x 8300 kg (Conductor)
+ 8000 kg (Mandrel) 42 t
Total weight of the coil 210 t

Material	Von Mises stress, Coil End [MPa]	Von Mises stress Coil centre [MPa]
Coil at 4.5 K		
Pure Aluminium	4→20	4→20
SC Cable	138→169	138→168
Al alloy	0→66	0→66
Coil at 4.5 K, energised		
Pure Aluminium	13→20	15→22
SC Cable	71→139	17→128
Al alloy	51→97	115→145

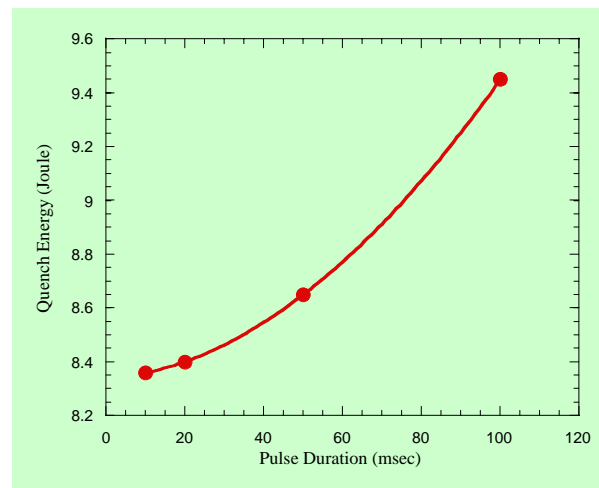



CMS Conductor

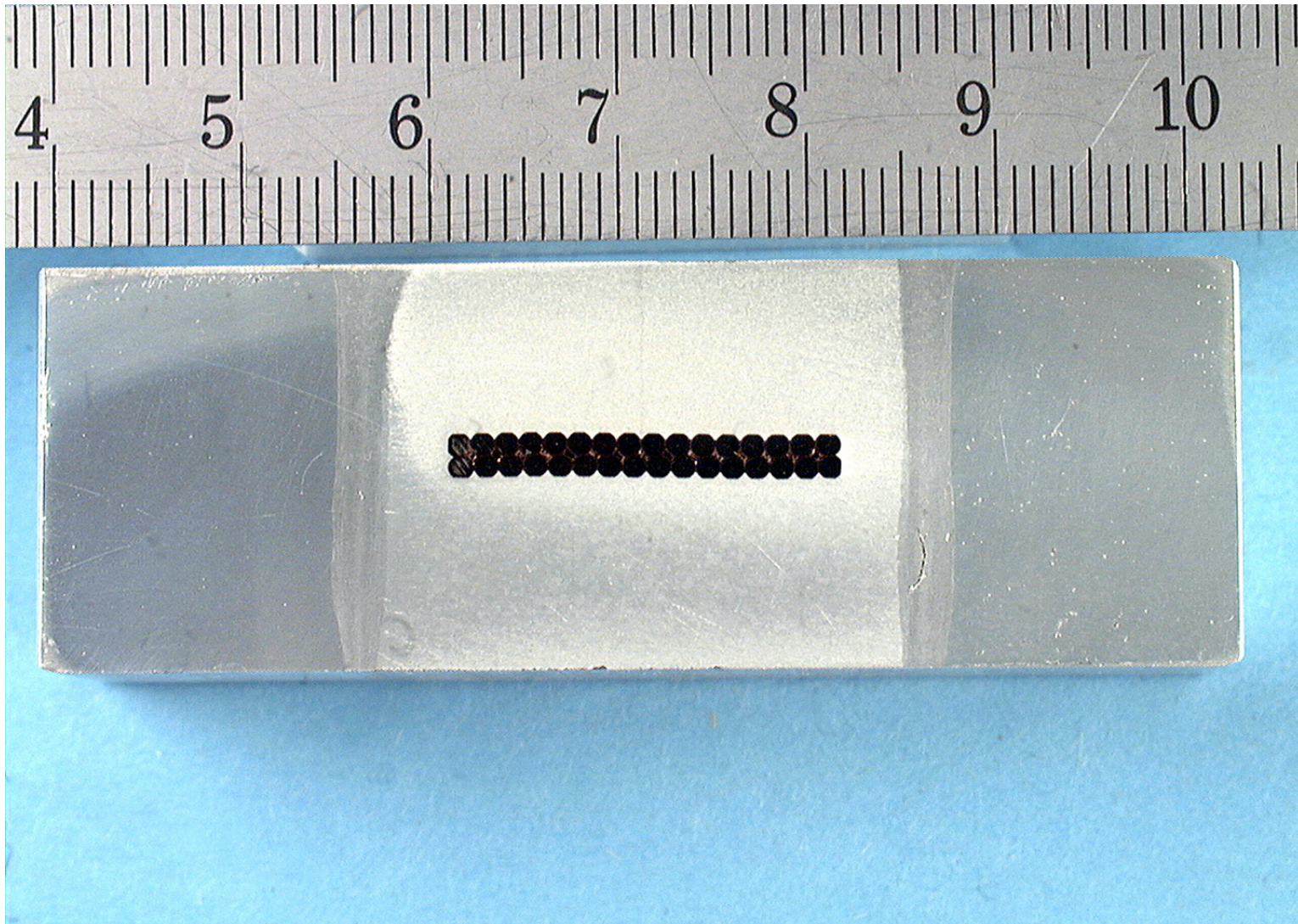



The Fabrication of the CMS conductor took place between 2001 and 2003







The
conductor is
wound in a 4
layer
configuration
Into AA 5082
Mandrel
By inner
winding
technique
and epoxy
resin
impregnation

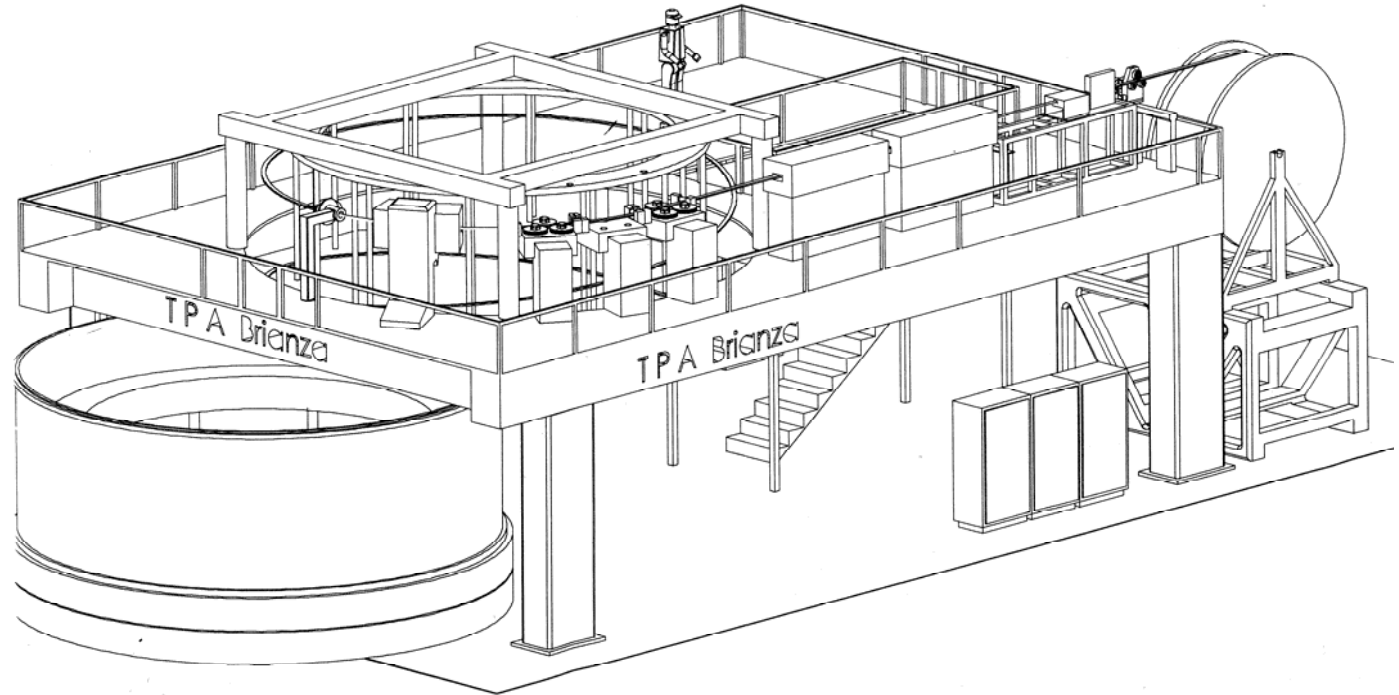



The winding has been done by ANSALDO Superconduttori under the supervision of INFN Genova from 2000 until 2005





Some details of module manufacturing

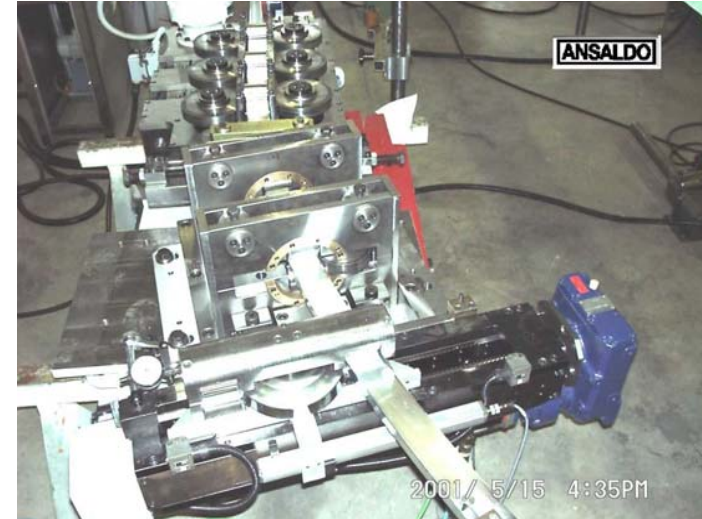



Impregnation of the first module

Feb 2003





Coil Module Transportation

Jan2004 / Feb 2005





Pile-up of module at SX5

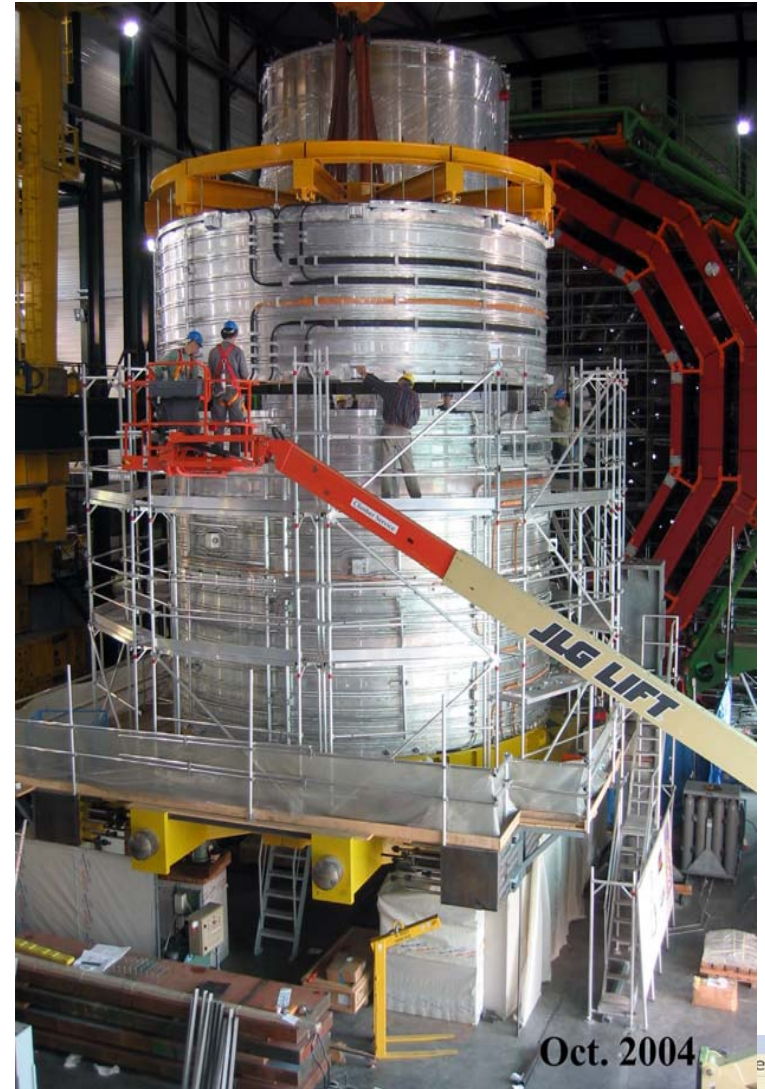



Electrical connection and instrumentation



Electrical joints and voltage taps



Hydraulic connections



The 5 modules piled up (February 2005)



The cryogenic circuit closed to the chimney



Thermal shield installation Feb-June 2005



Thermal shield assembly by Criotec (I)

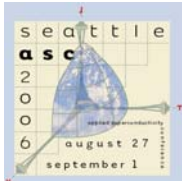



Coil Swivelling August 2005



August 2005: Coil swivelling





Coil insertion





The Inner thermal shield being inserted in its vactank Sept 2005

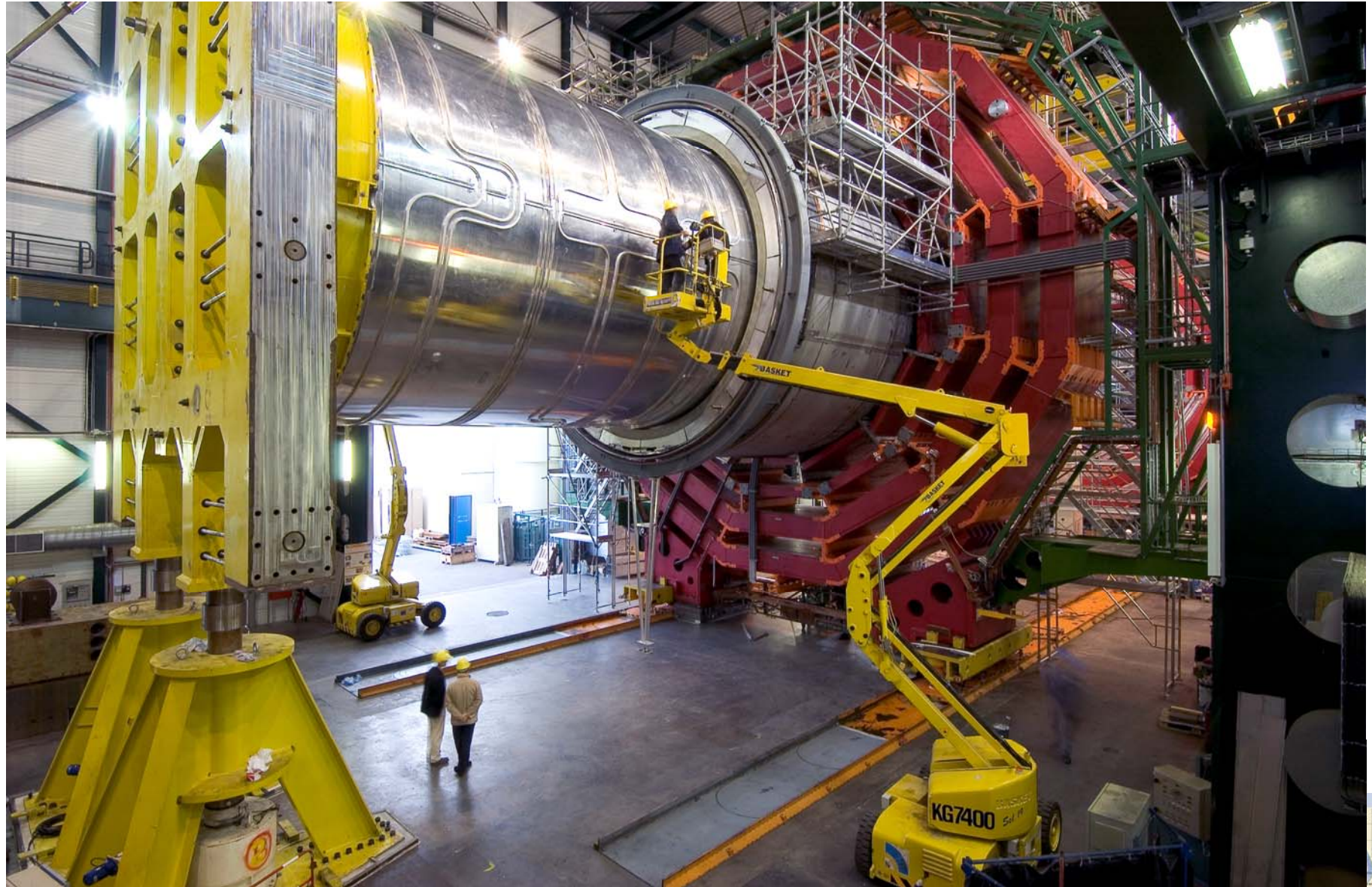



Connection to the cryogenic chimney



The cryogenic chimney links the cold mass to the phase separator cryostat by SDMS (F)





Installation and connection of the current leads

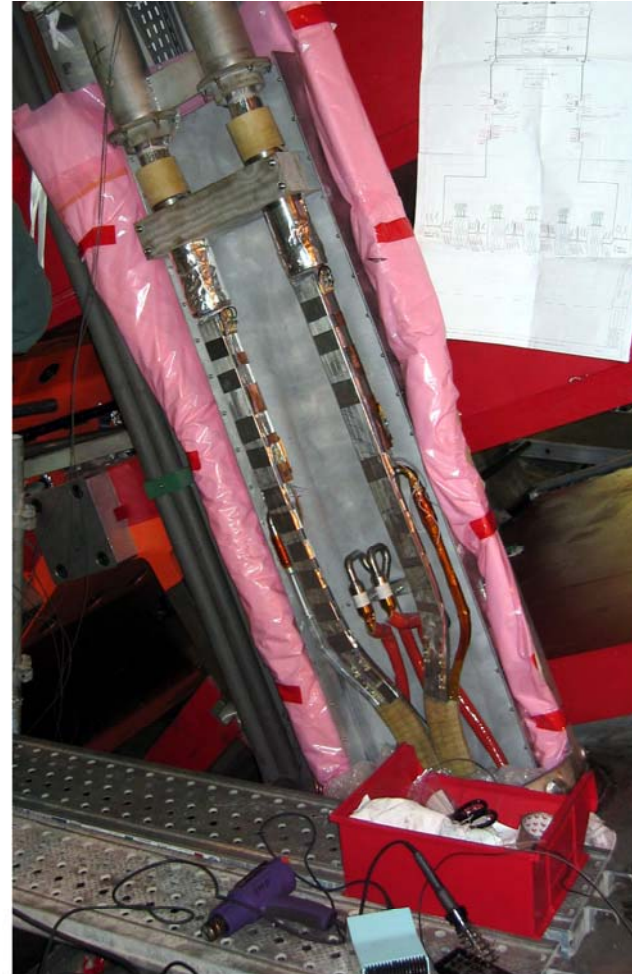

The current lead chimney assembly





Closing of the vacuum tank flanges

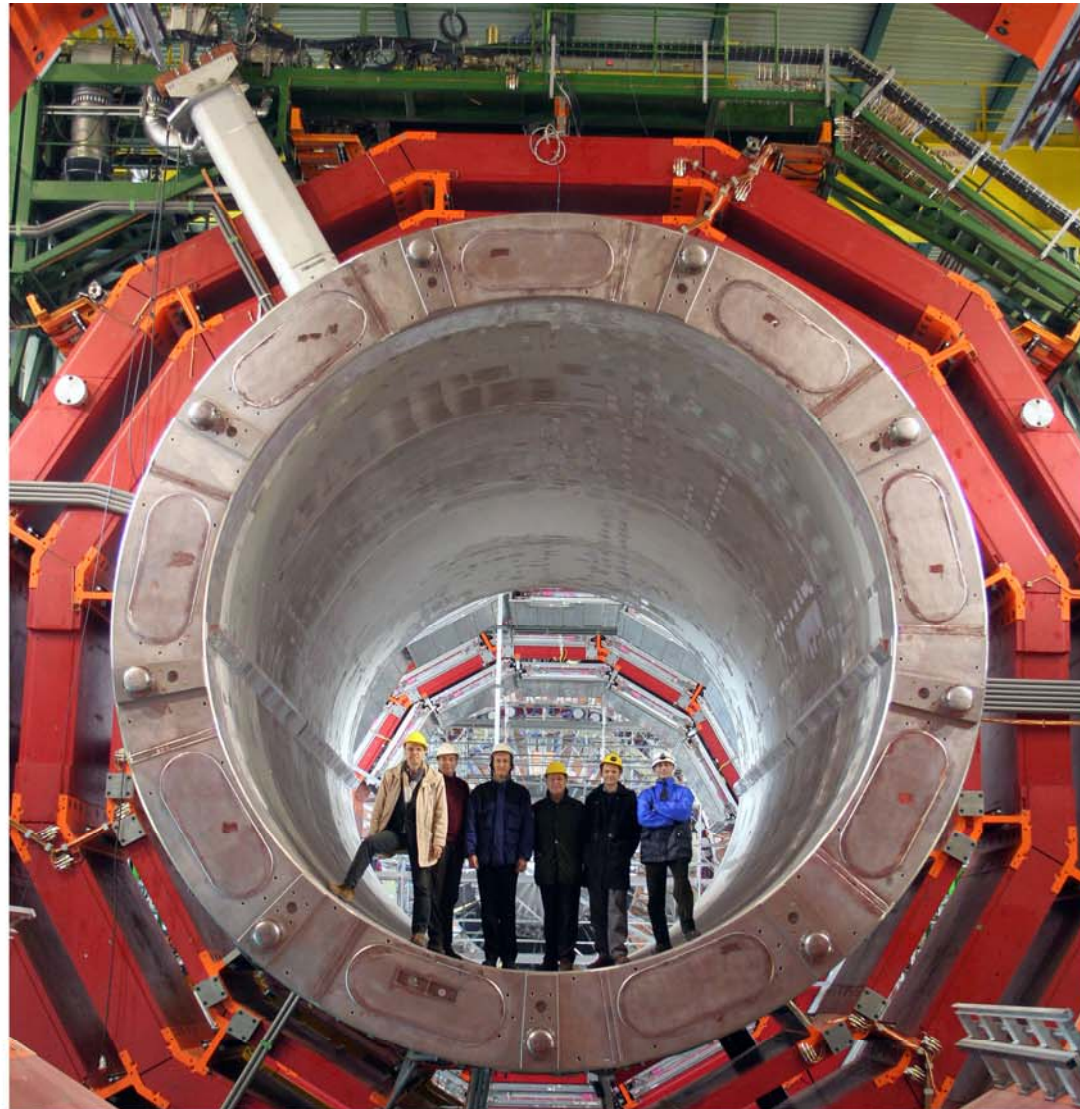

January 2006: End of the CMS Magnet Manufacturing



Test Configuration in the SX5

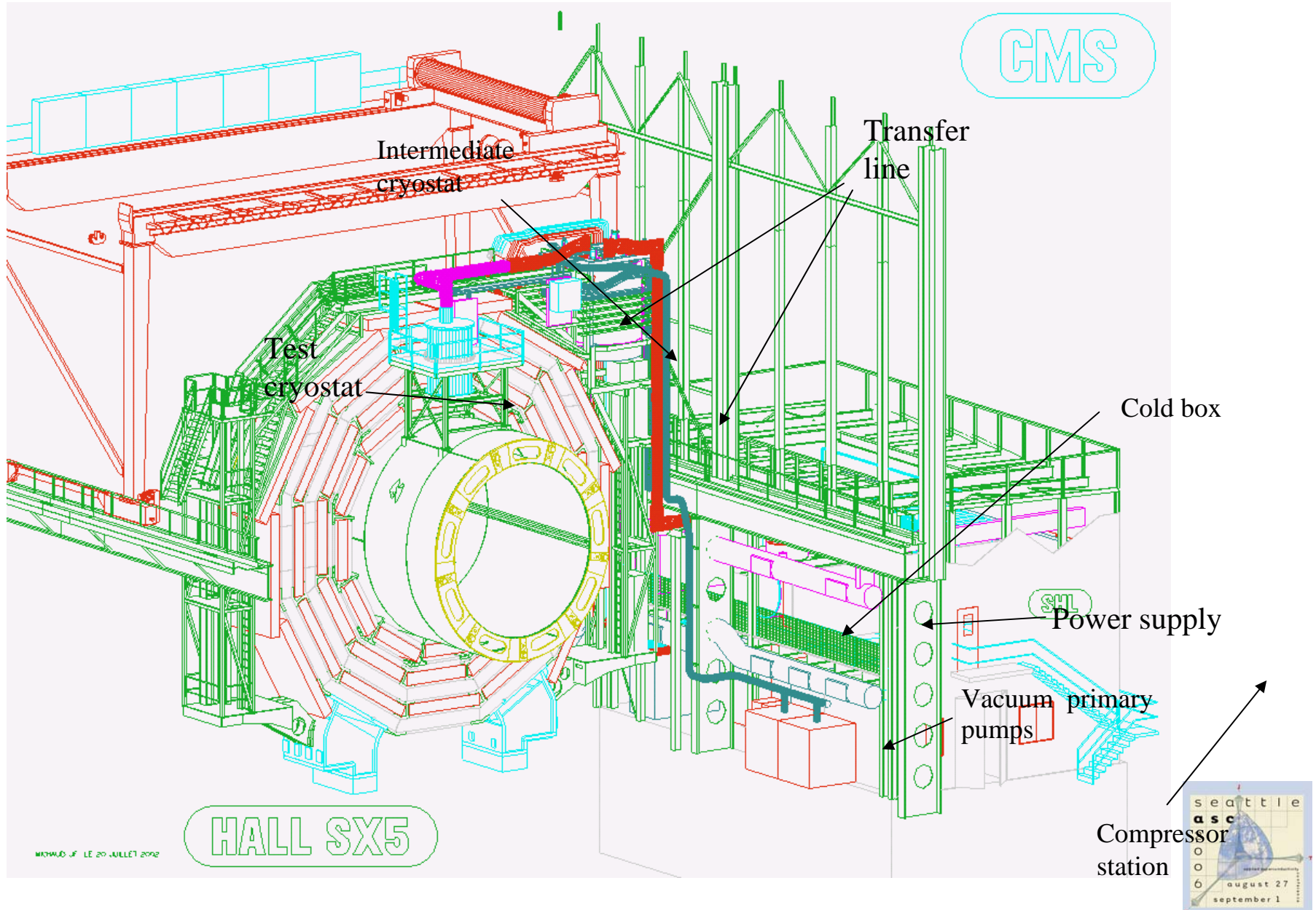



Electrical scheme

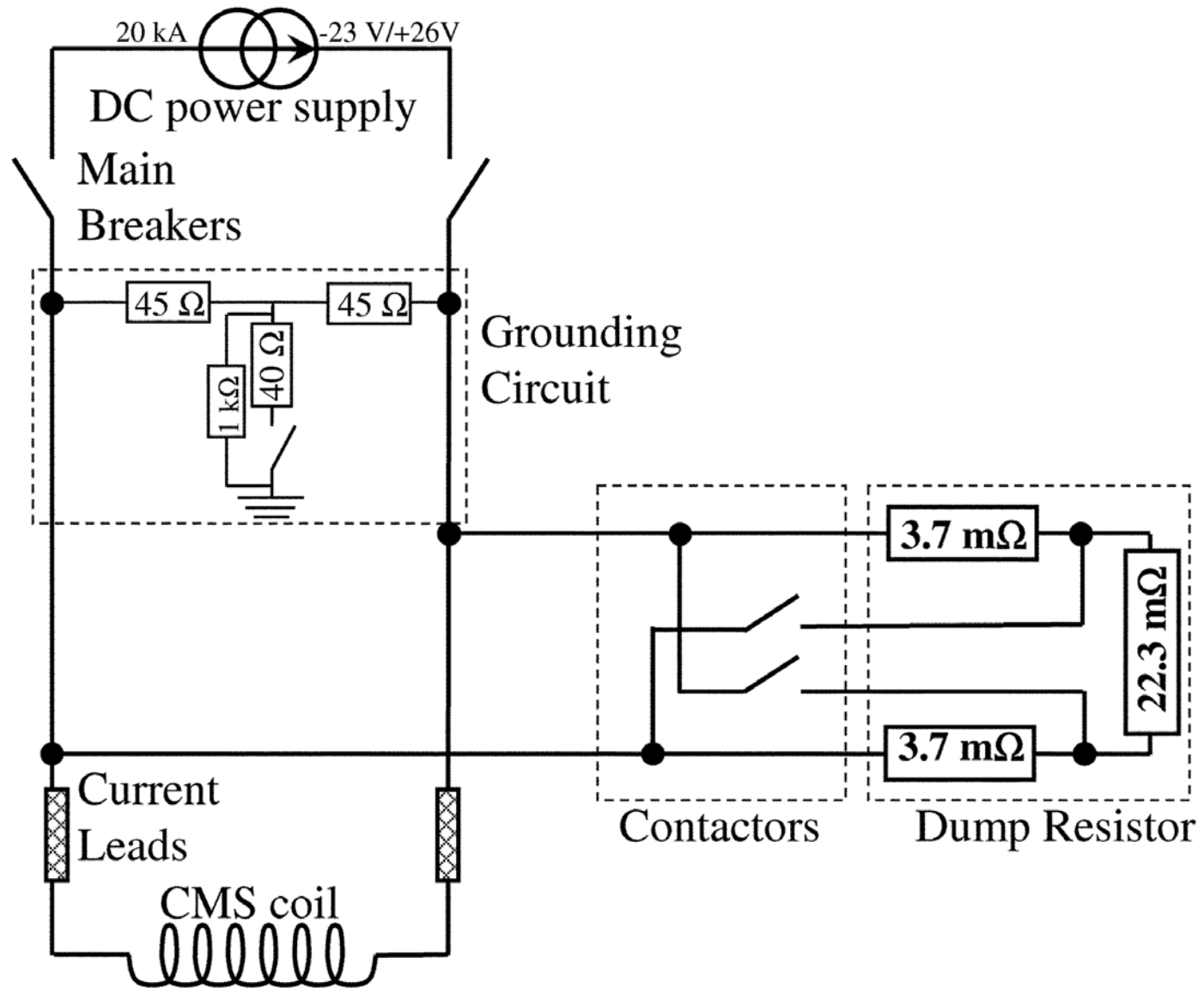



CMS Power Converter: 20 kA; +26/-23 V



Type: Thyristor bridge rectifier,
bipolar in voltage,

Output nominal voltage: -23V .. +26V

Output nominal current: 20000 A

Nominal power for ramping-up: 520 kW

Mains supply voltage: 400V, 50Hz, 3-phase

Mains supply current: 320 Arms

Voltage ripple: 1 %

Current precision: 5 ppm pk-pk

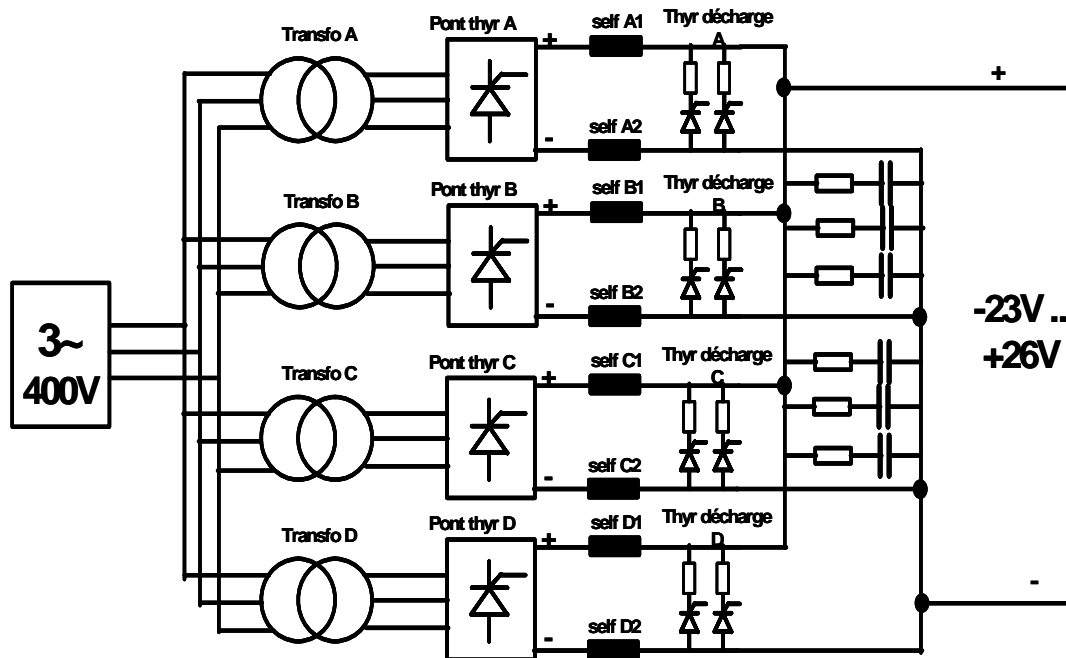
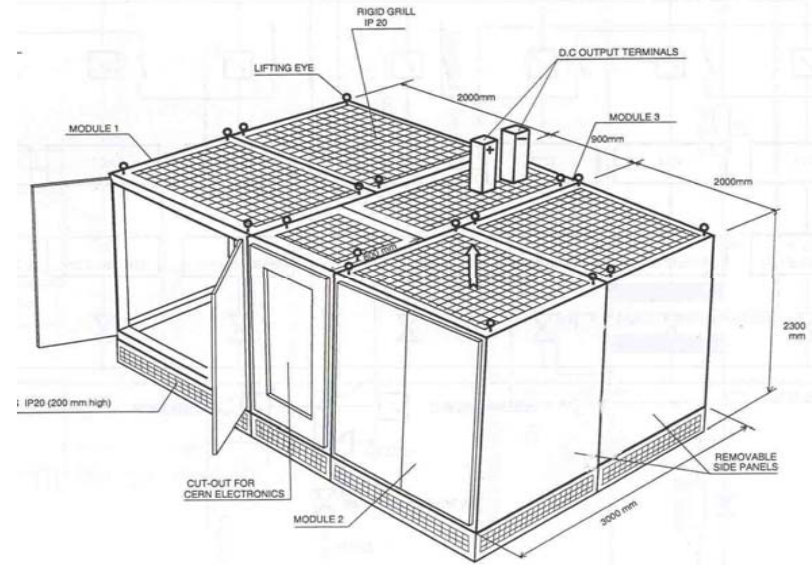



Dump resistor at SX5





Cryogenics

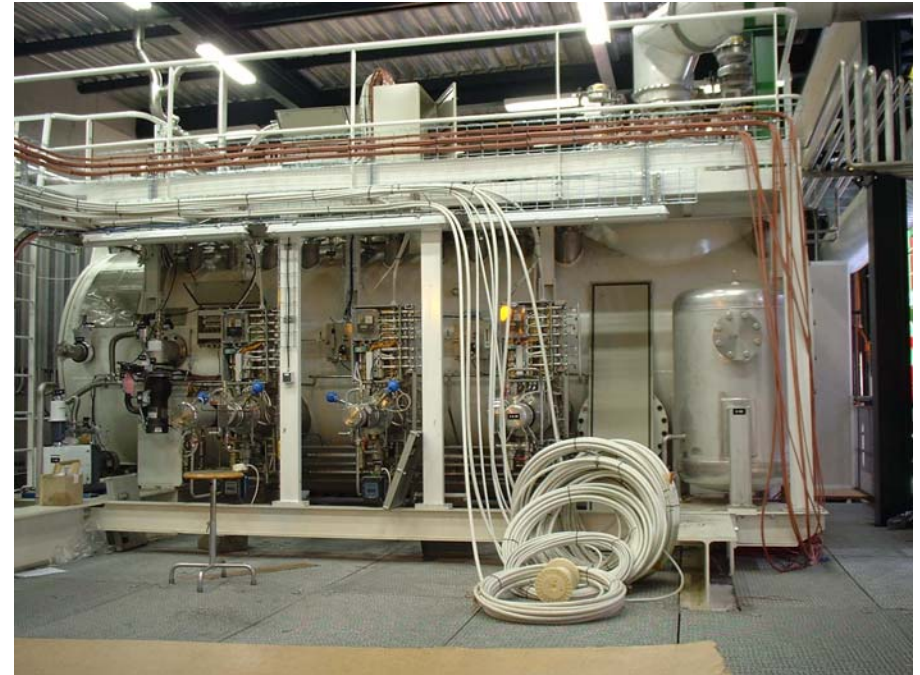

The plant has been specified for the following performance:

- During cool down : up to 30 kW
- In steady state : 800 W at 4.45 K + 4500 W at 60-80 K + 4 g/s liquefaction
- In failure mode : up to 40 g/s liquefaction

The compressor station, installed in 2001 has been commissioned mid 2002

The cold box has been installed from May to Nov 2002 and commissioned from July 2003 until March 2005

Some problems encountered due to oil coalescer performance (which generated pollution of the circuits) and start up of the 3rd stage turbine in the cold box (which had repetitive failure)





Nominal performance of the cryo plant were reached in March 2005 with the help of an additional thermal load to simulate the coil



- Refrigeration power as a function of T

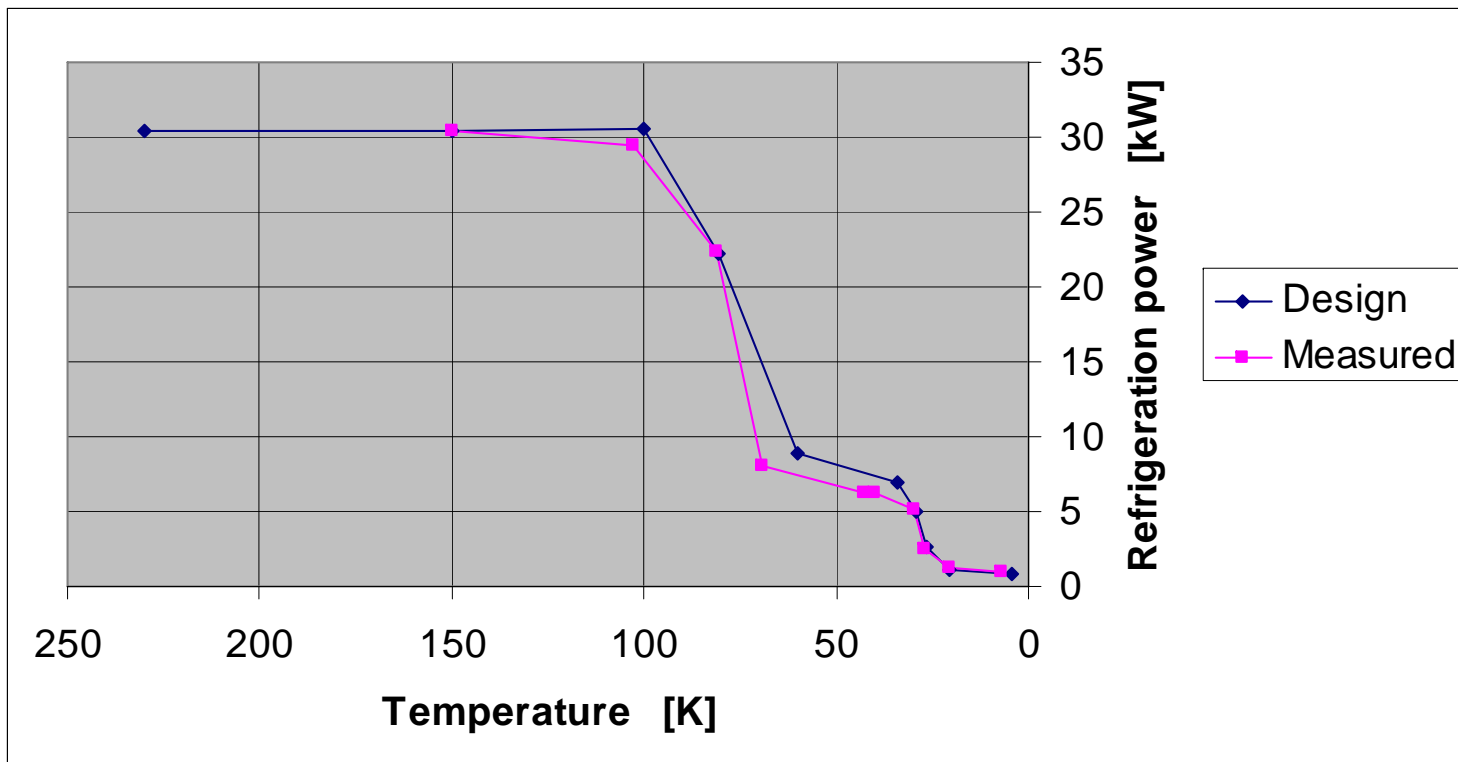



Preparation of the Magnet Test



- The Magnet Commissioning has been coupled with a so called Cosmic Challenge Test to show good working of the whole detector
- This goal has implied the mounting of a significant part of Muon Chambers in the Yoke and Hcal + Ecal + Tracker parts
- The exercise has lasted until July 2006





Ecal Module Insertion

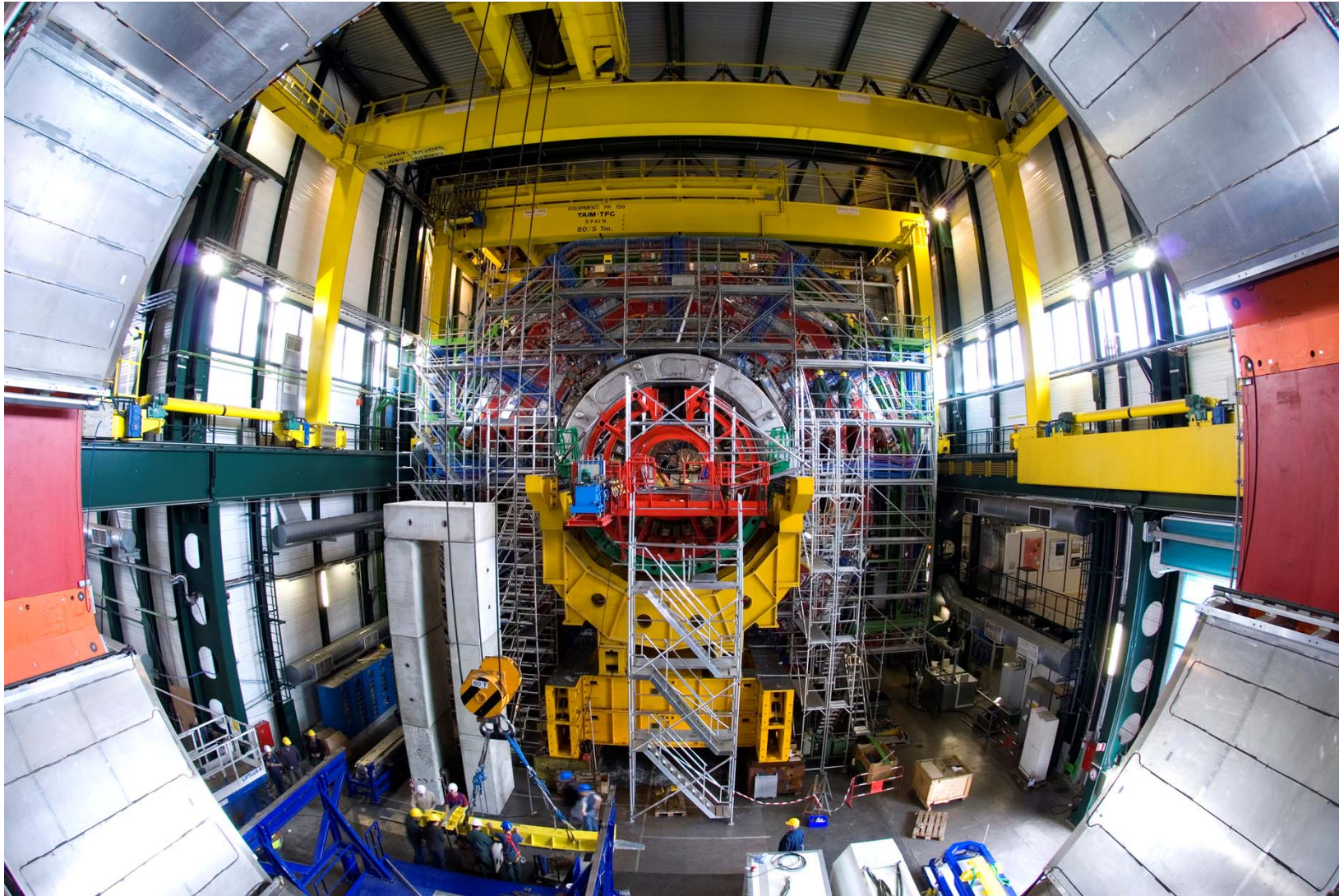



Insertion of the Tracker

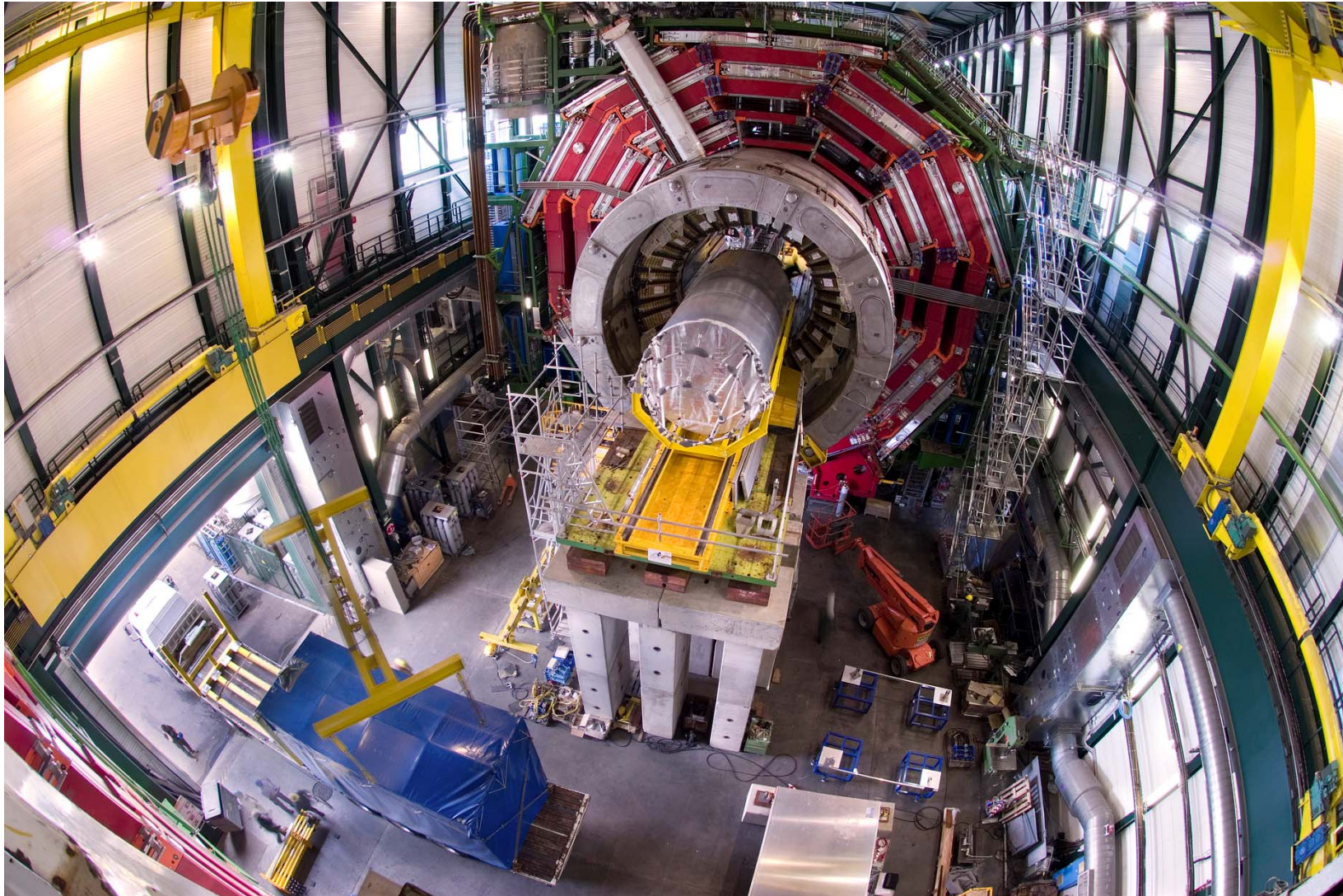



HCAL Barrel insertion

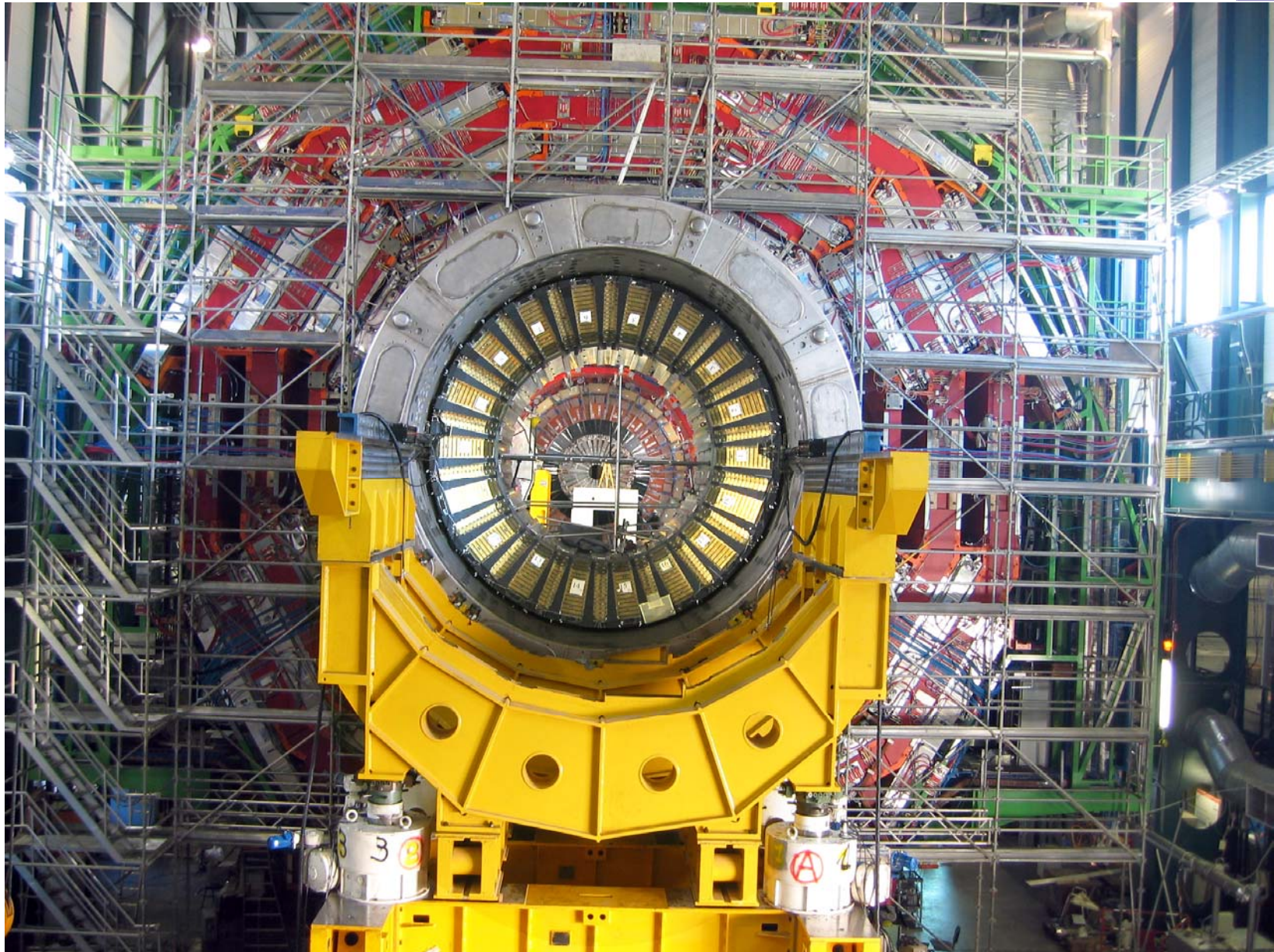



Barrel Yoke ready for closure with endcaps

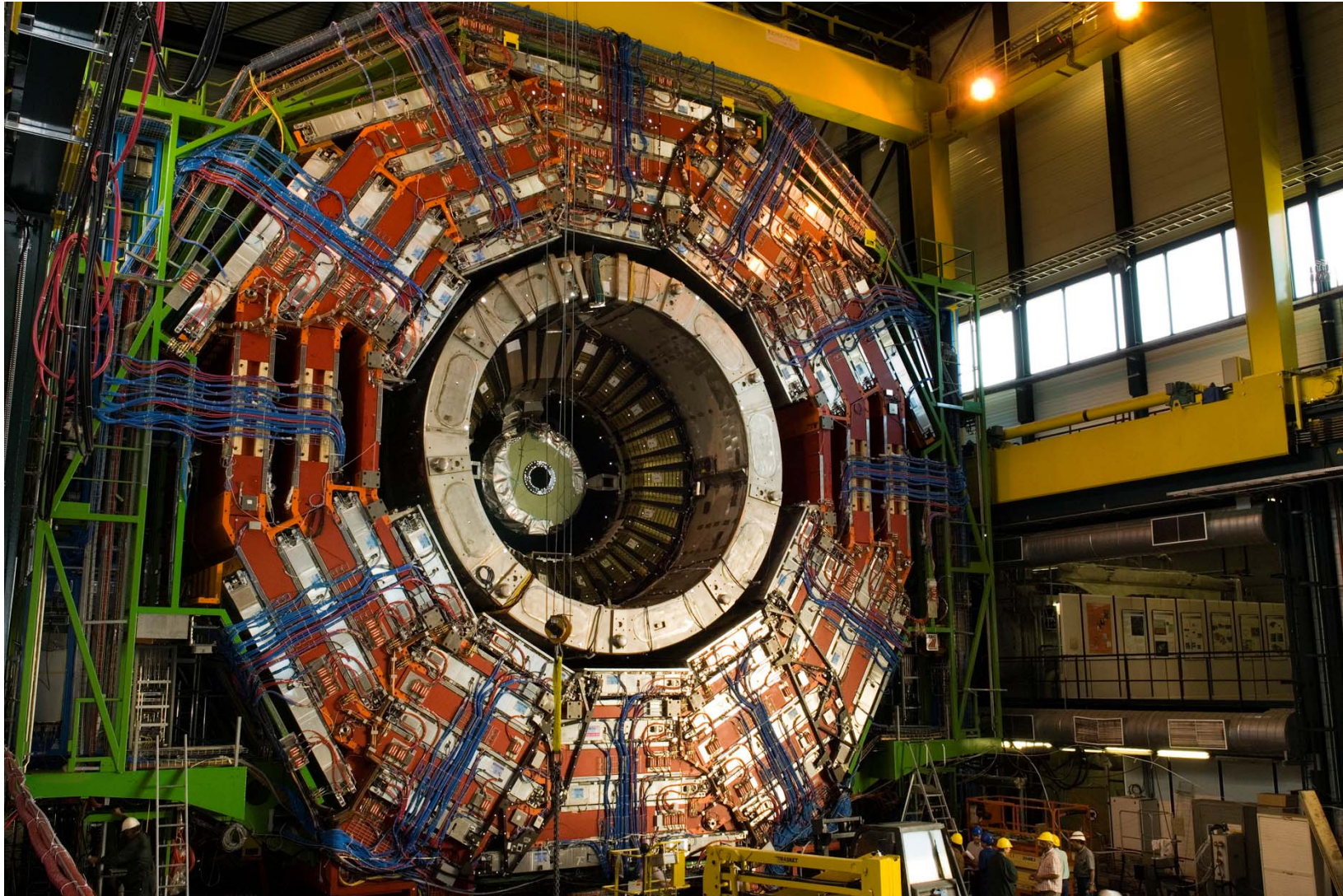



Survey has been constantly assured to reach an alignment of 1 mm wrt the ideal axis

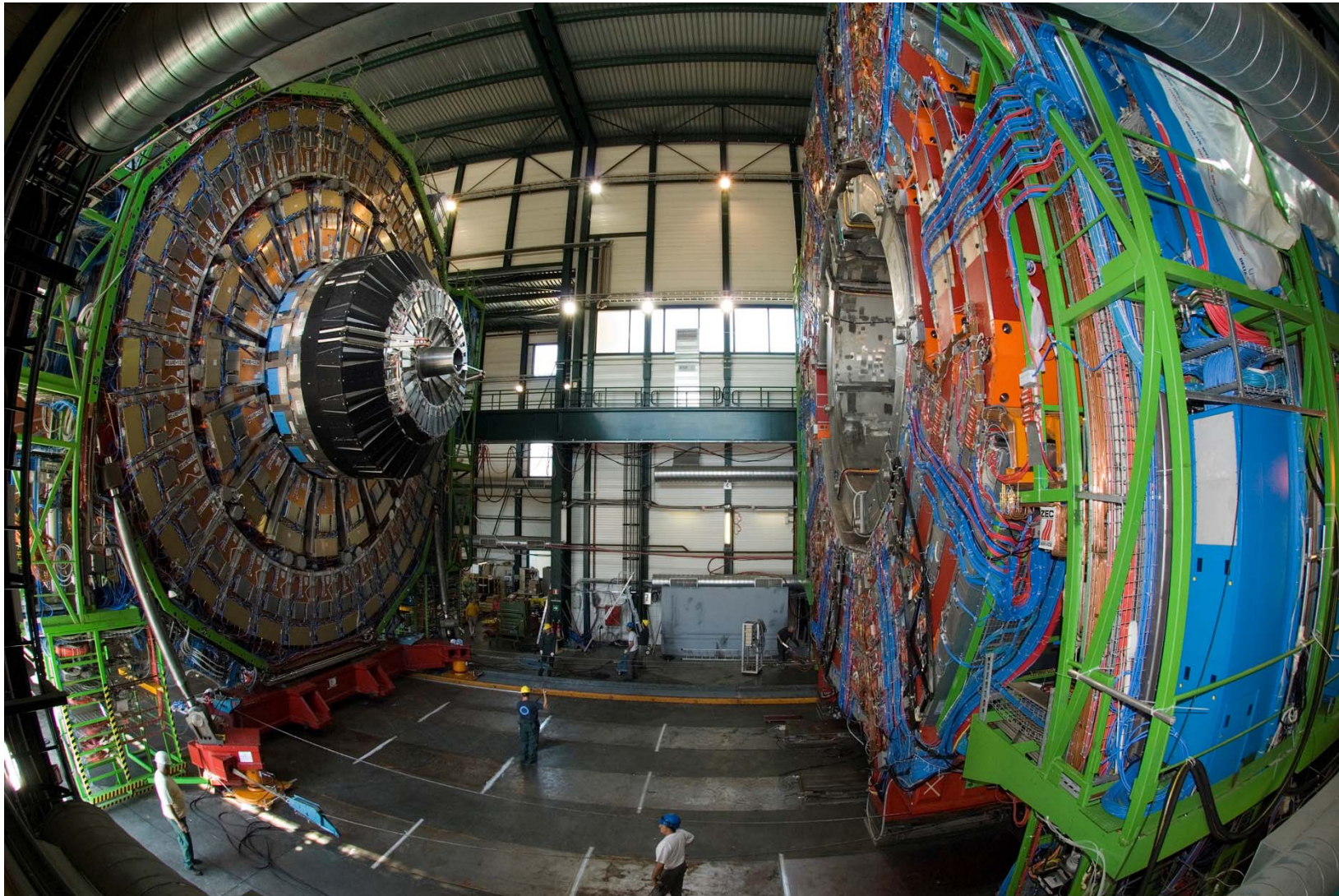



Mid July 2006

CMS Closed: ready to inject high currents

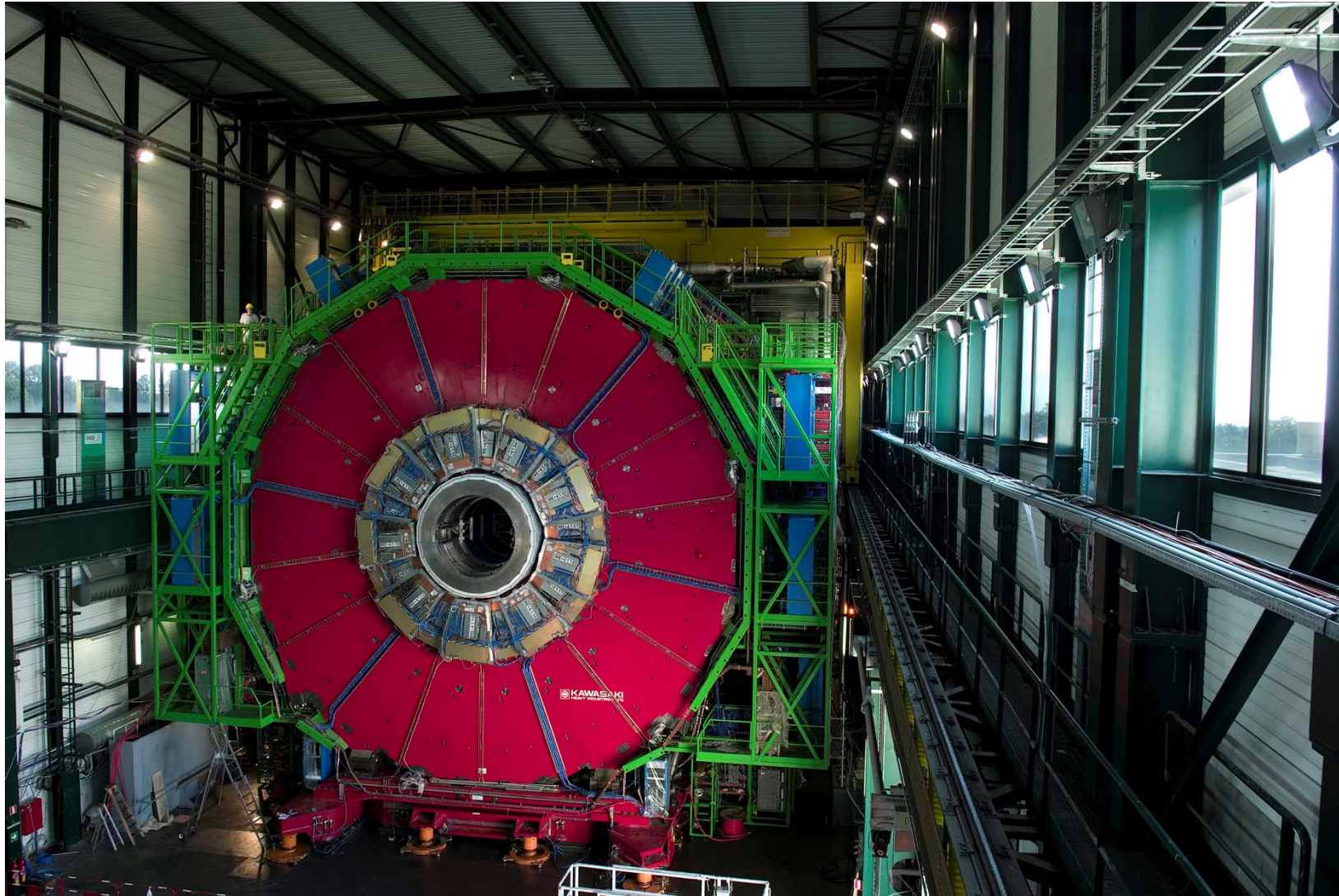



Status of the tests



- After cool-down the coil has been charged to nominal field (4.0 T – 19 kA) and discharged through FD
- Several parameters are being verified: Field/Current ratio, Inductance, Stresses, Temperature distribution, Temperature after a FD, Misalignment, Displacements of Iron Yokes

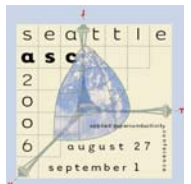



Ramp-up and discharge



FD = 190 s

TDPC = 3.2 h
(1.7 A/s)

SD = 5 h

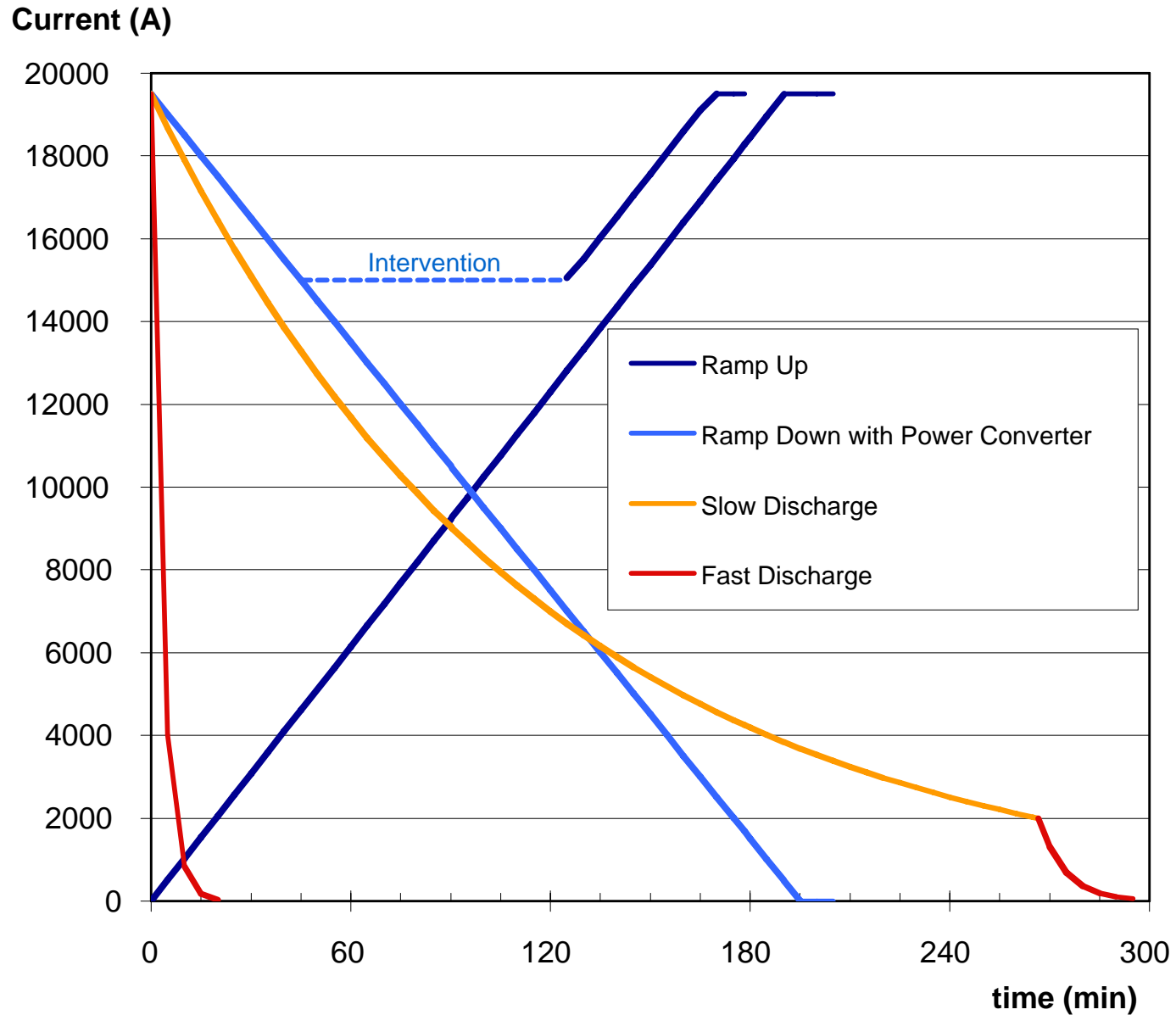



Planned current cycles



March 23th 2006

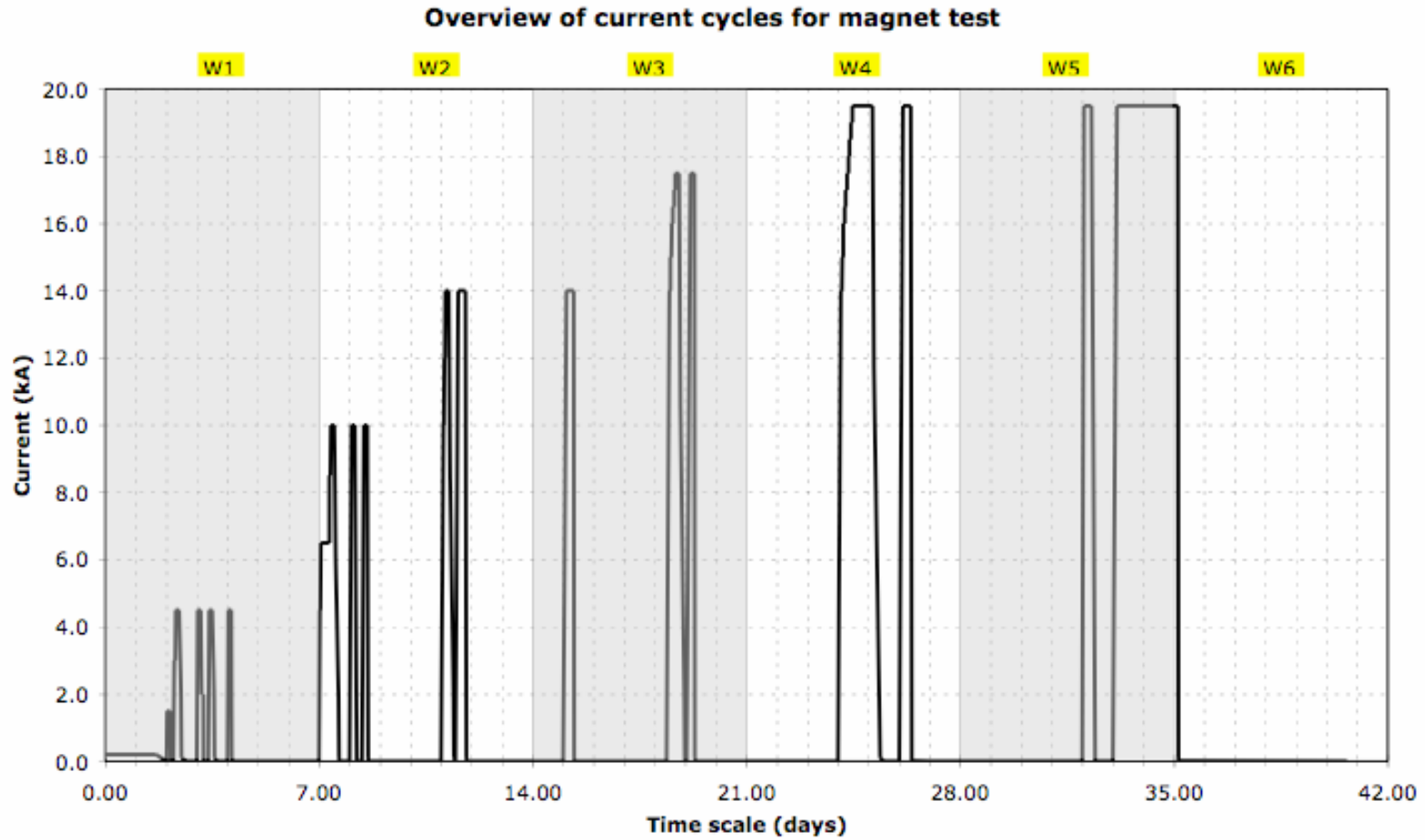



Cool down of the Coil



300 K

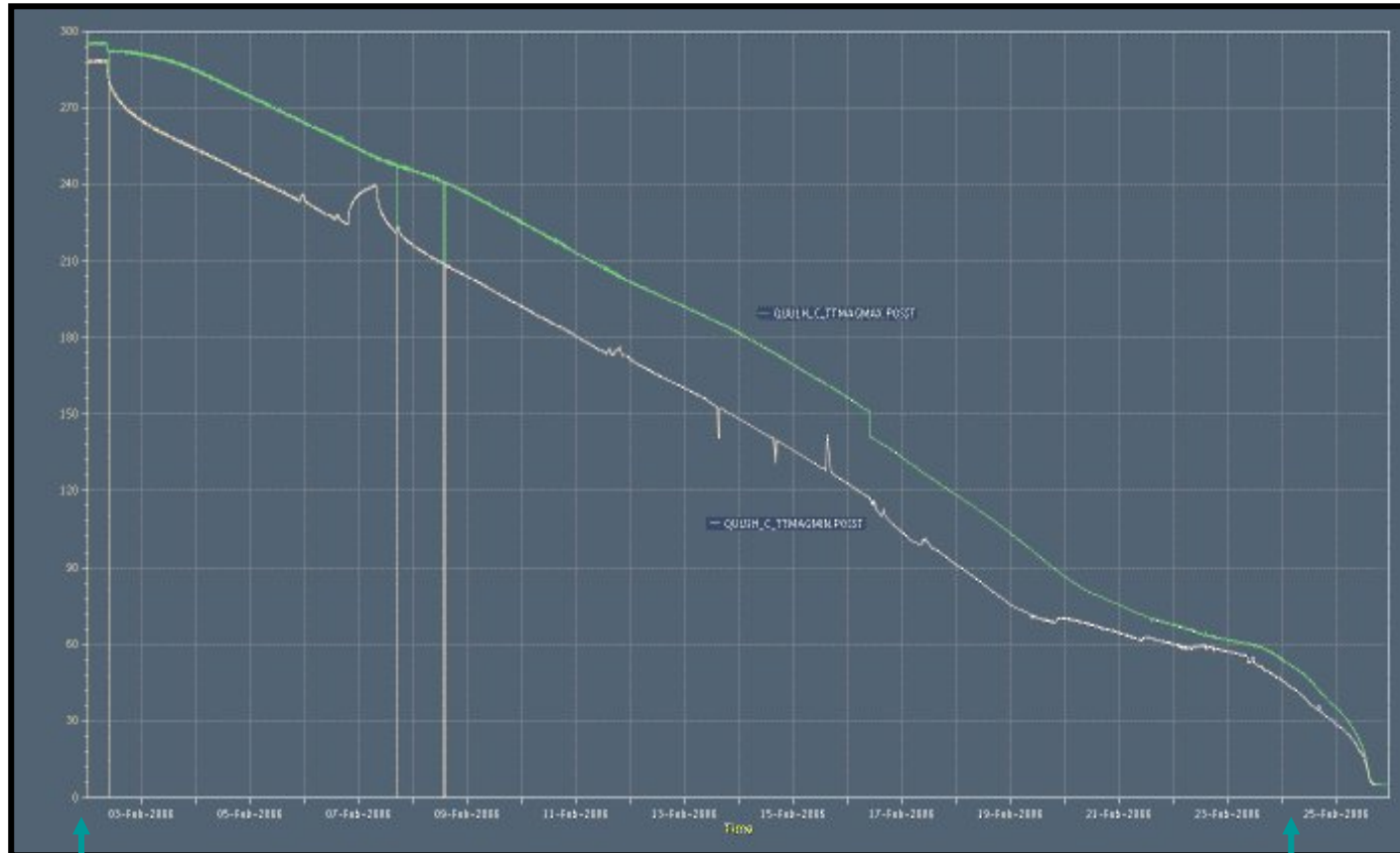

4 K

3 Feb 2006

25 Feb 2006





Current cycle from 0 to 15 kA and FD

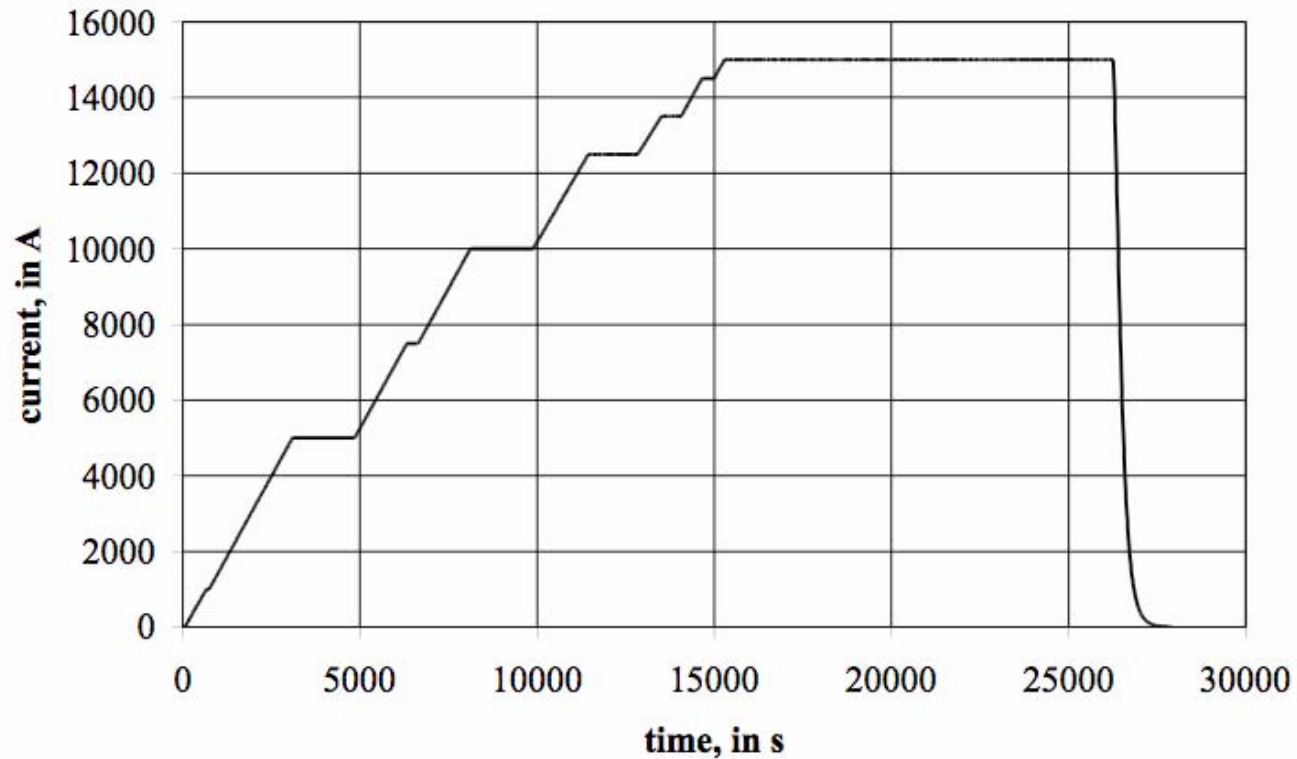



CMS Magnet ramping of 22.8.06 and measured field on outer Radius

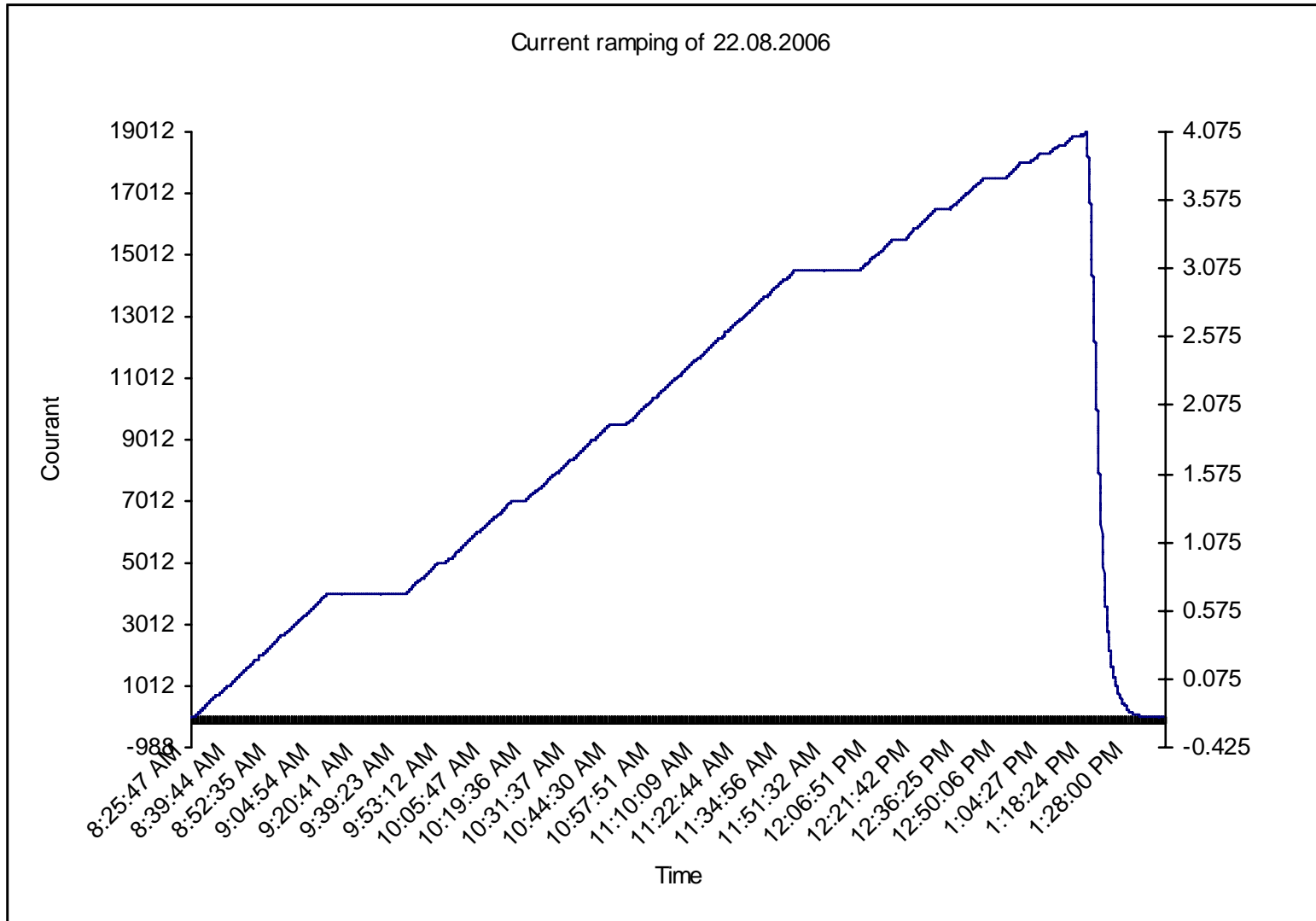



Longitudinal Displacement on the cold mass



Mean contraction: 27 mm => no displacement of the coil

Displacement
in mm

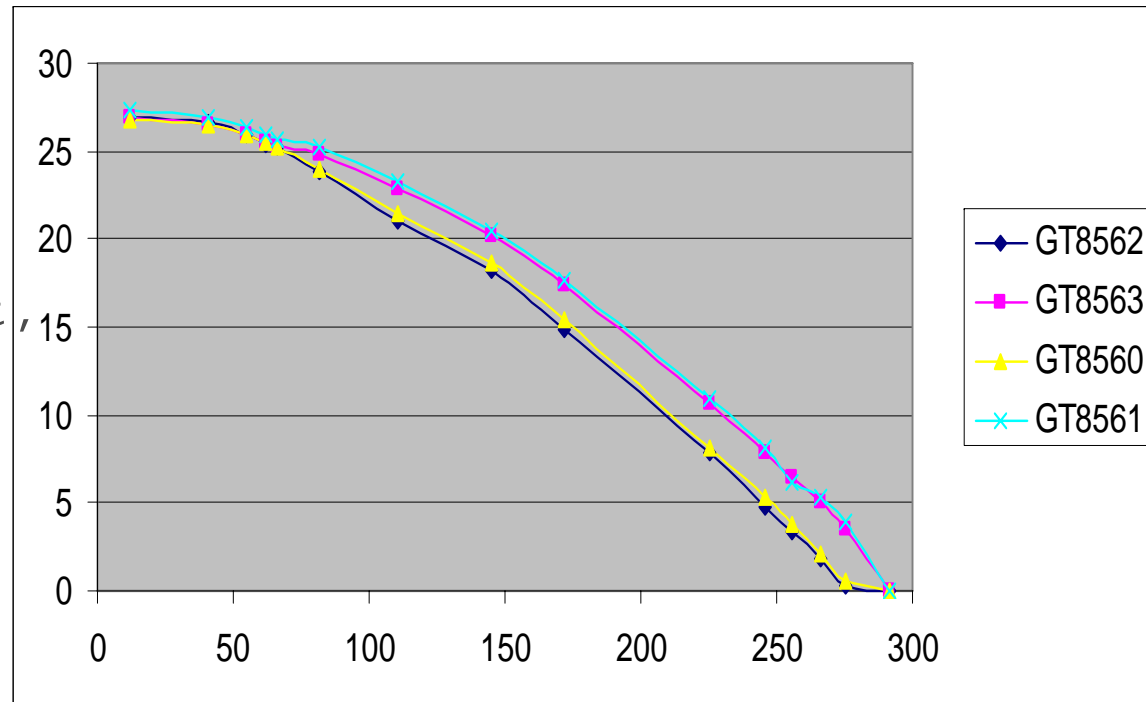

Temperature, in K





Temperatures and current decay after a FD at 15kA

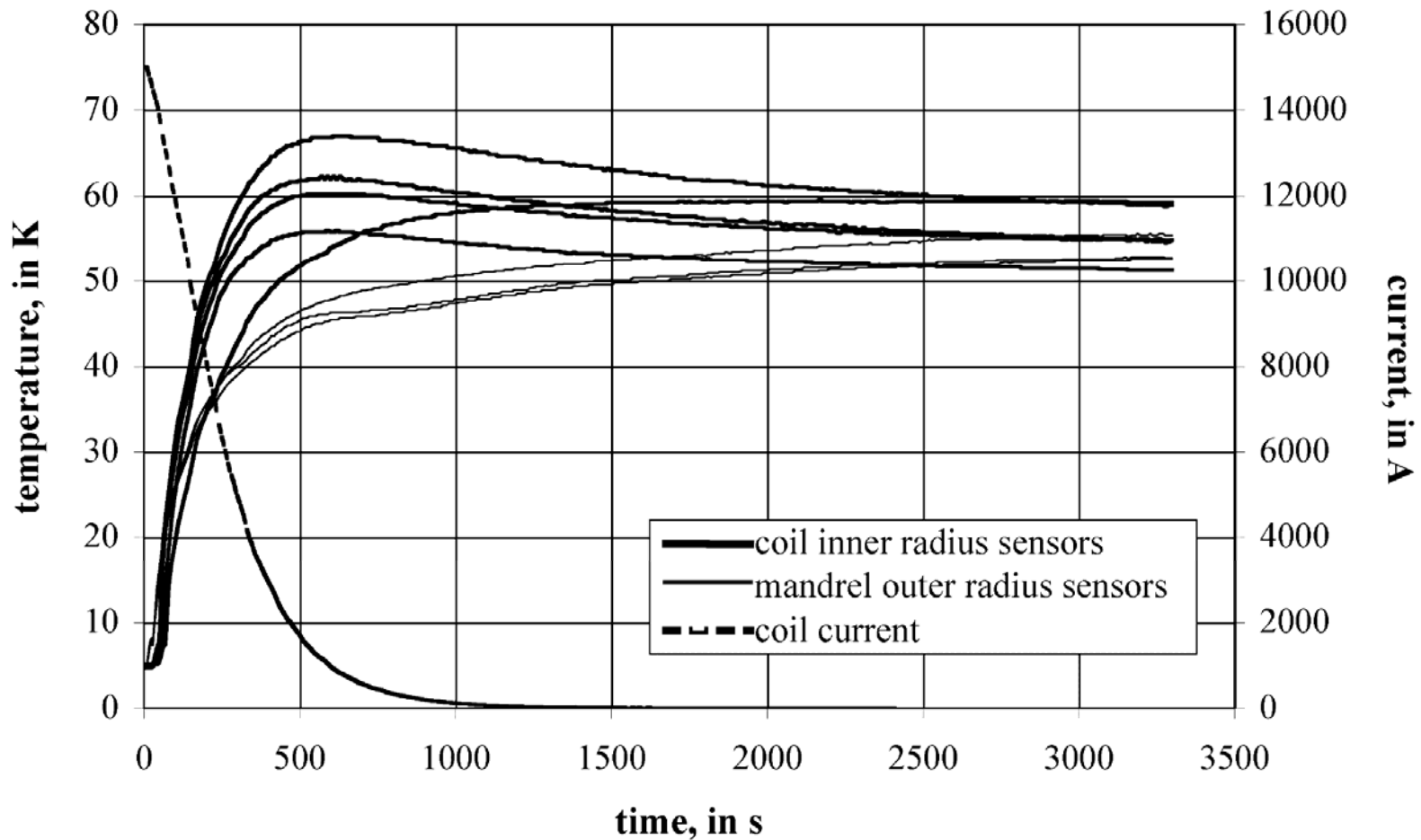



FD current normalised wrt time

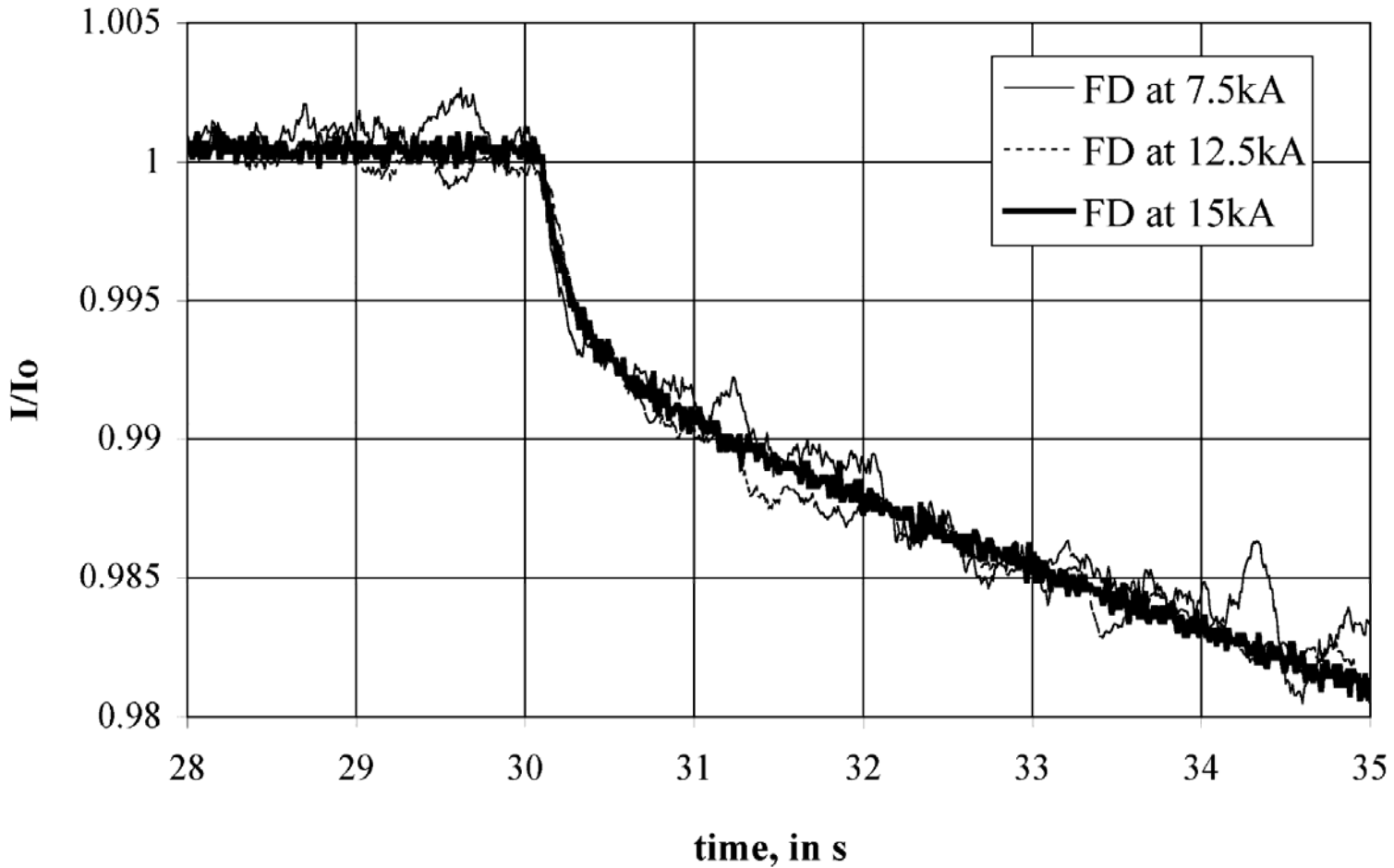



Voltage on the Coil during a FD at 15 kA

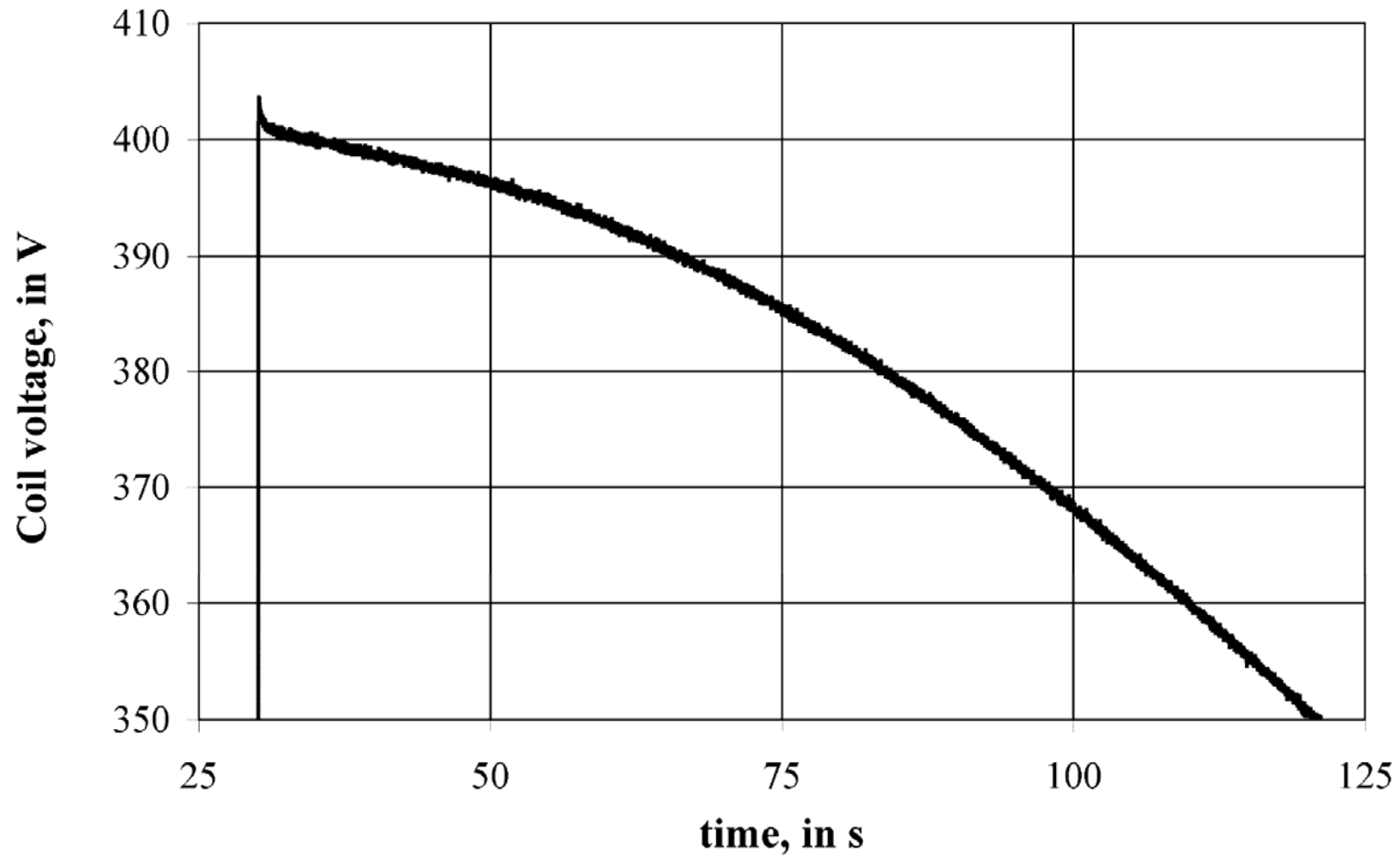



DISPLACEMENT OF DISK YE+1



RectiLinear
Position transducer

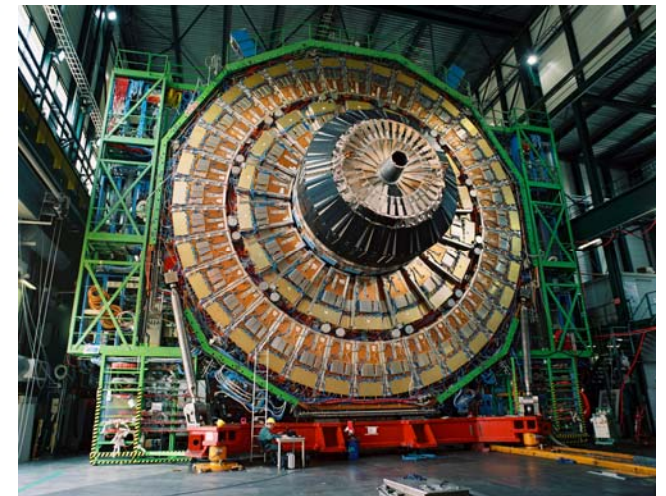
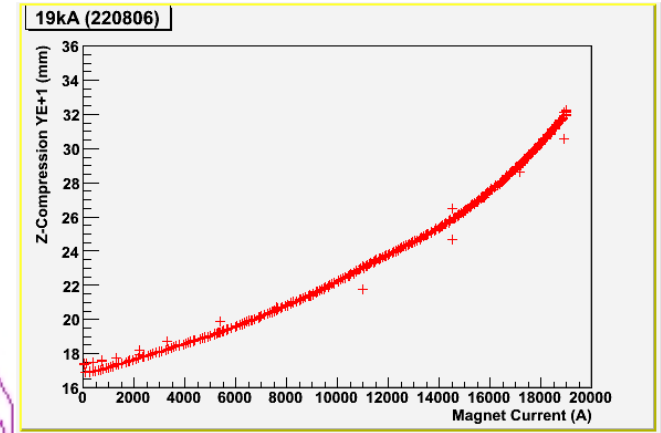
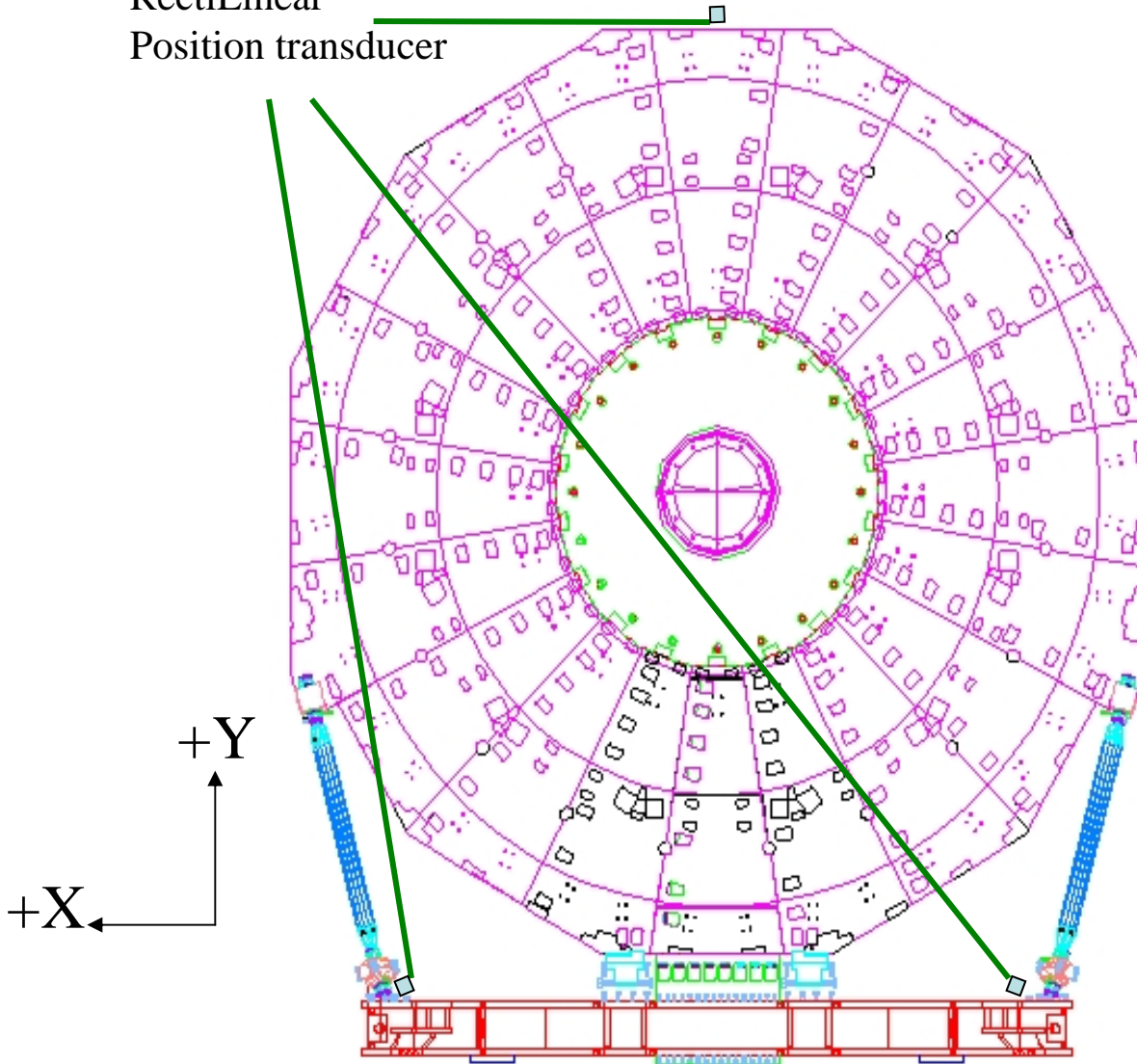



Current and Coil R during FD

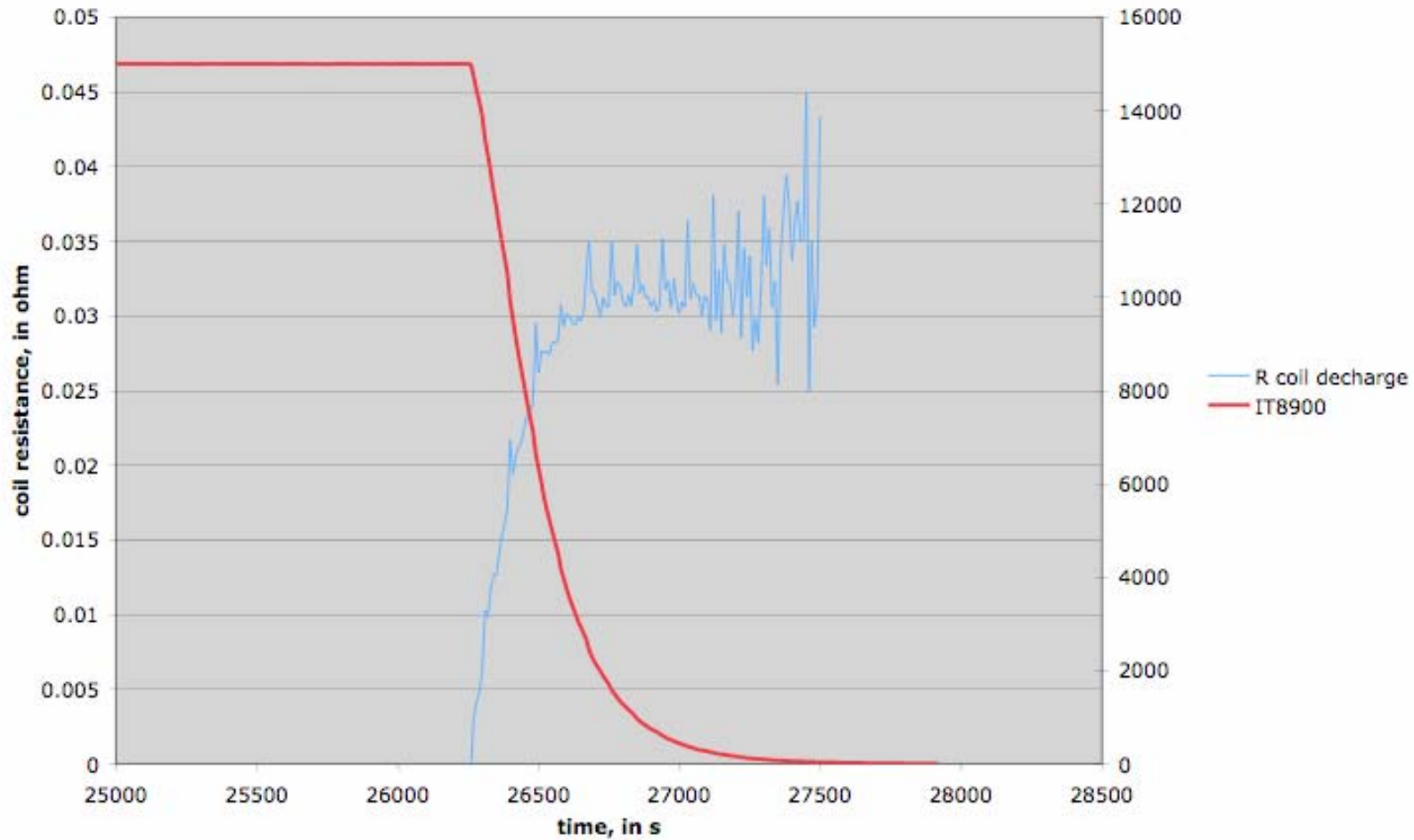



Cryogenics



- The cold mass cryogenic consumption is 135 W at 4.2 K + 20 W in the phase separator
- Dynamic losses would reach 150 to 200 W but has not yet been measured due to (wanted) frequent stops during ramping
- The calculated values are:
 - static heat load - 137.5 W + 20 W phase separator
 - dynamic load - ramp up - 60 W
 - dynamic load - slow discharge - 190 W
- Peak values - 365 W





He pressure during Fast Discharge

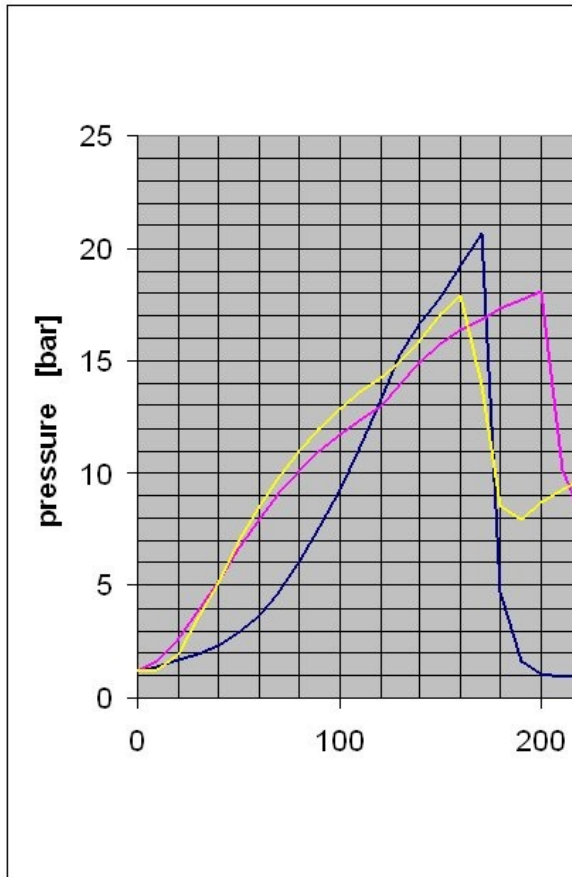



Stray field

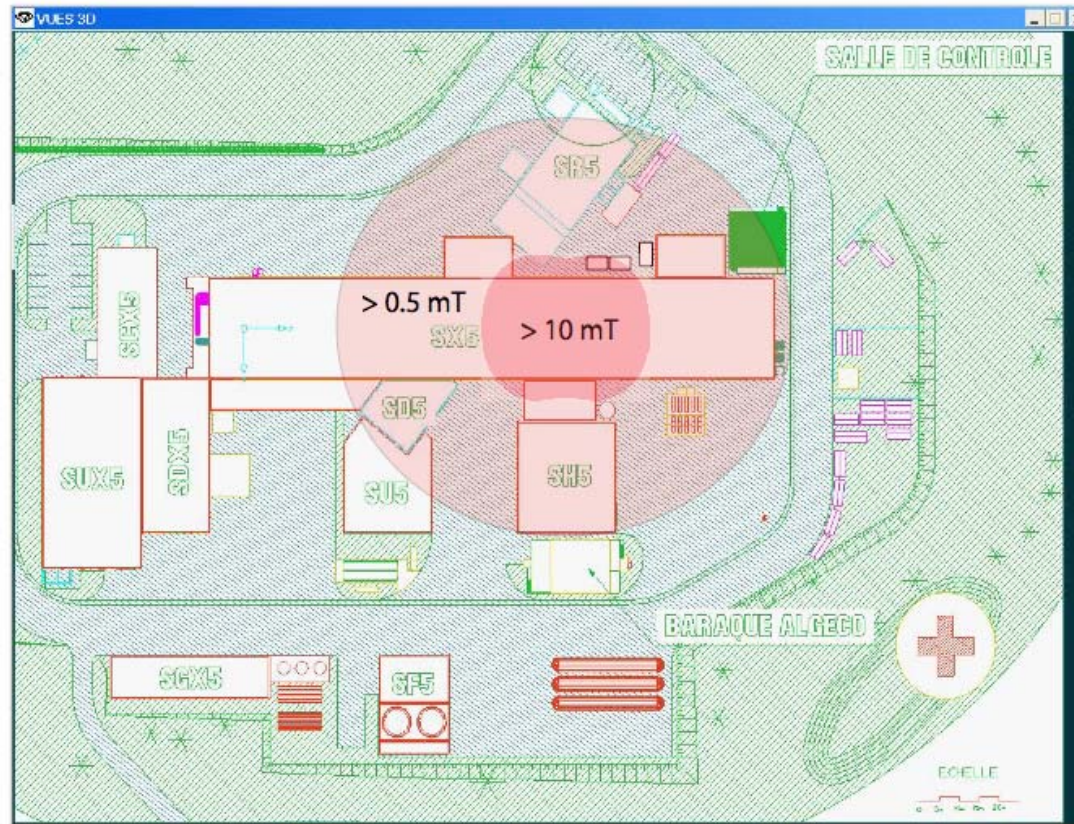

0.5 mT for pacemakers and other electronic implants and 10 mT safety limit for public - magnetic field in a plan 0.5 m below the IP when the magnet is run at the maximum current of 20kA

Some problems on ancillary components due to the stray field. The saturation of a DCCT has induced a FD





CONCLUSIONS



- After 14 years from early design and following R&D, pre-industrialization activities, 6 years of construction and about one year for installation, CMS magnet is now under test.
- From cryogenic, electrical and mechanical tests the coil looks to fulfill specifications
- After a period for field mapping, the magnet and detectors will be installed into ...





.... the cavern and ...

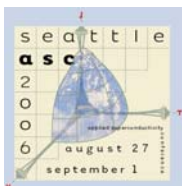
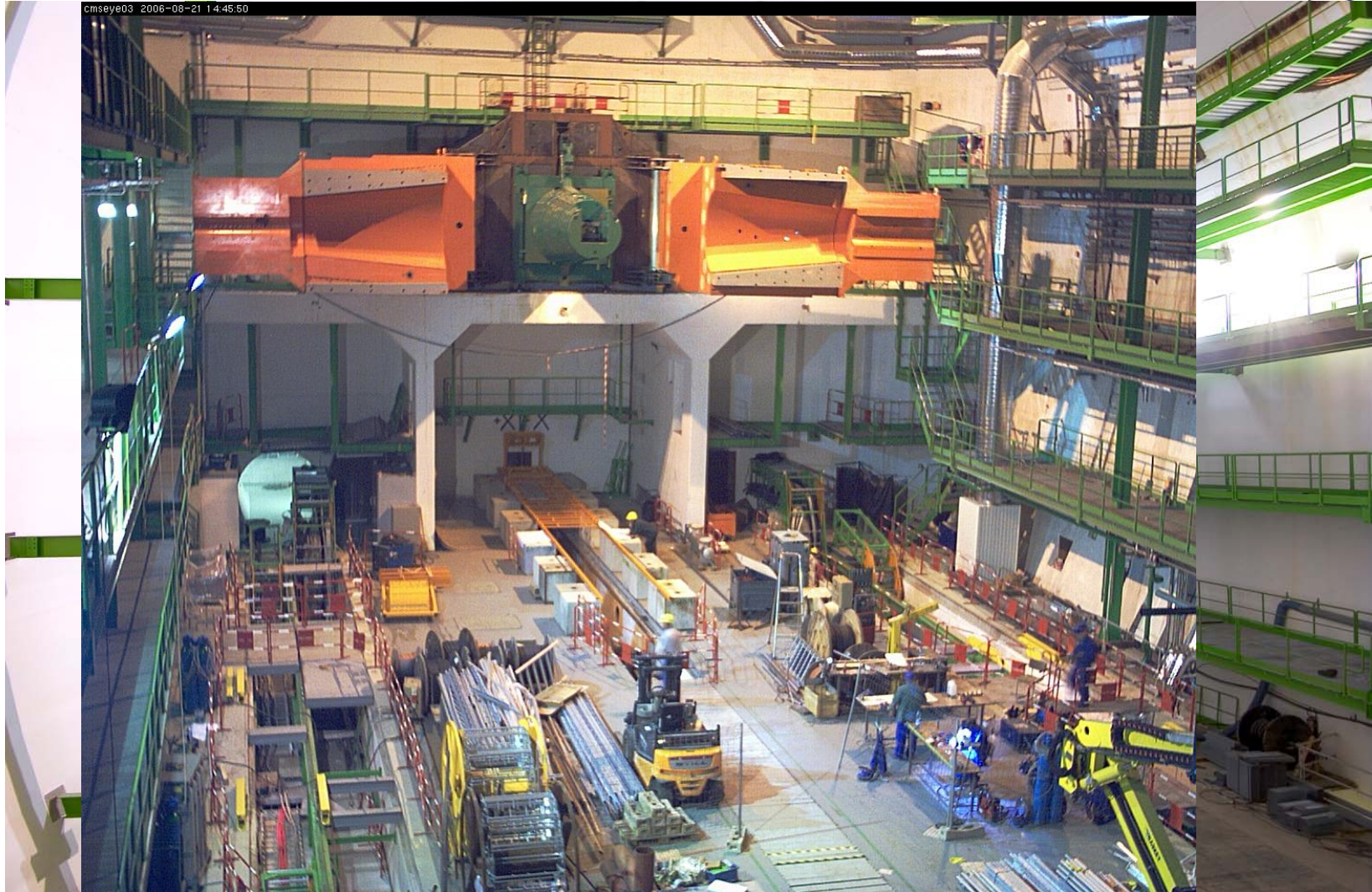



...ready for physics in 2007

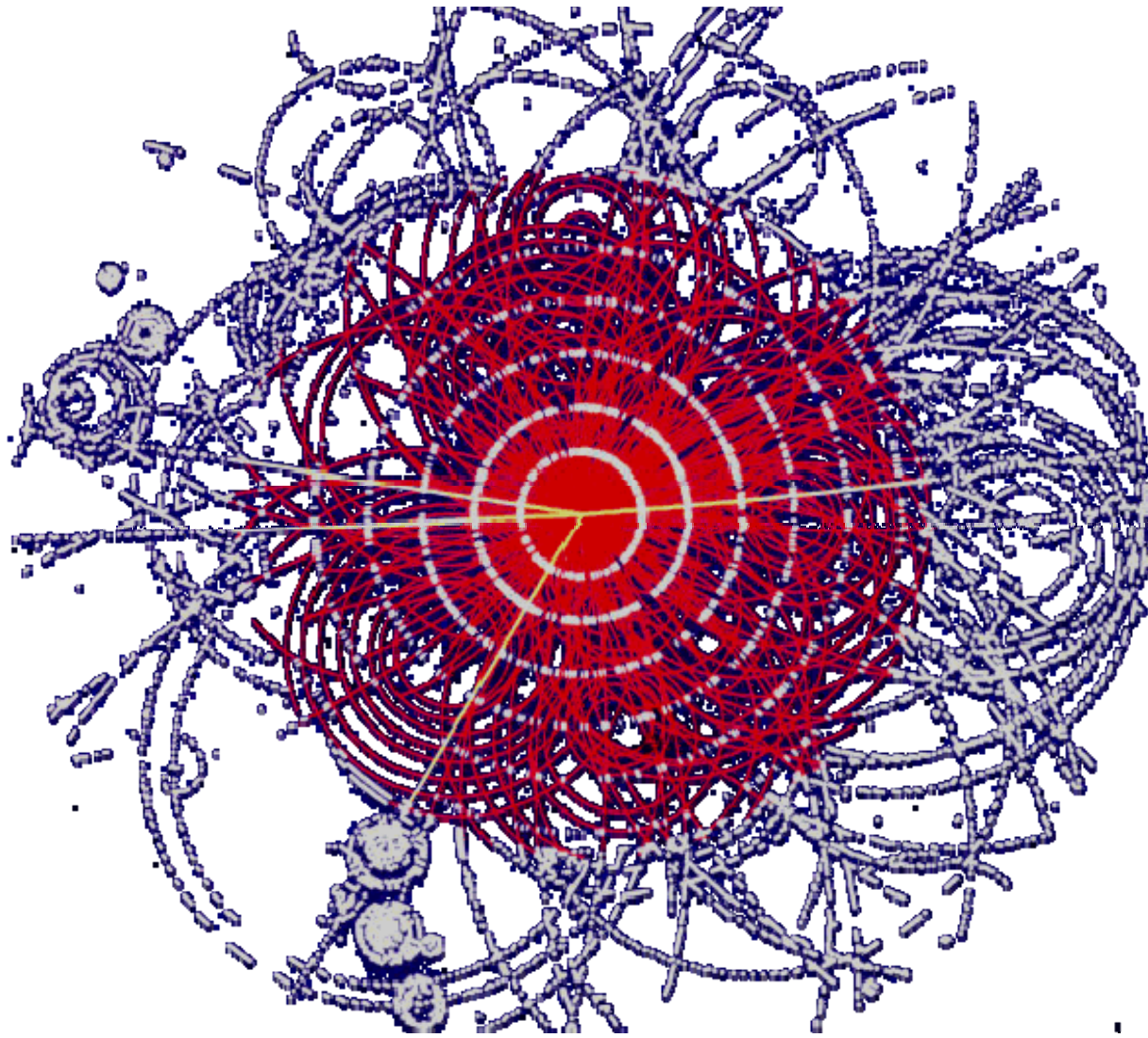



NOT USED SLIDES





CB0 module being assembled

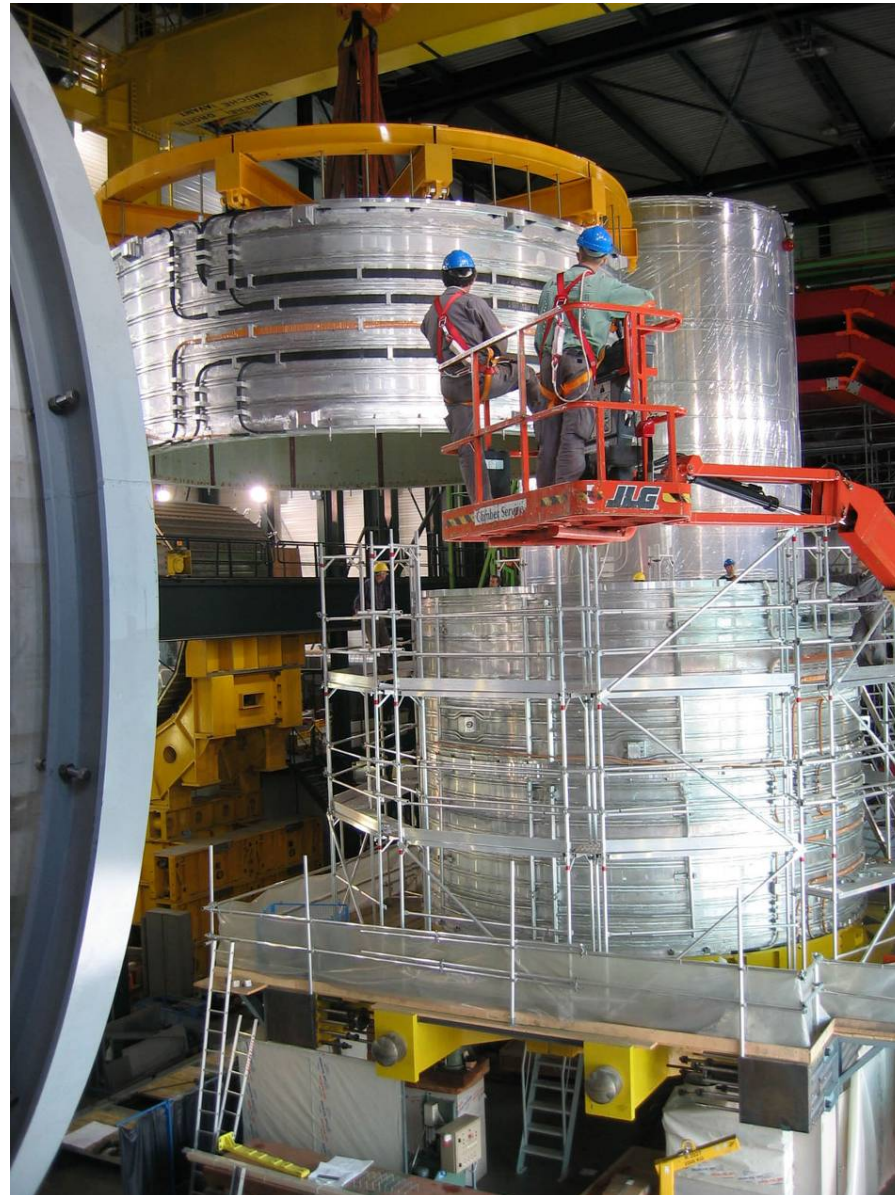

The busbar are bended during the insertion



Coil insertion into the outer vacuum tank



Bus-bar bending during insertion



Inner shield insertion

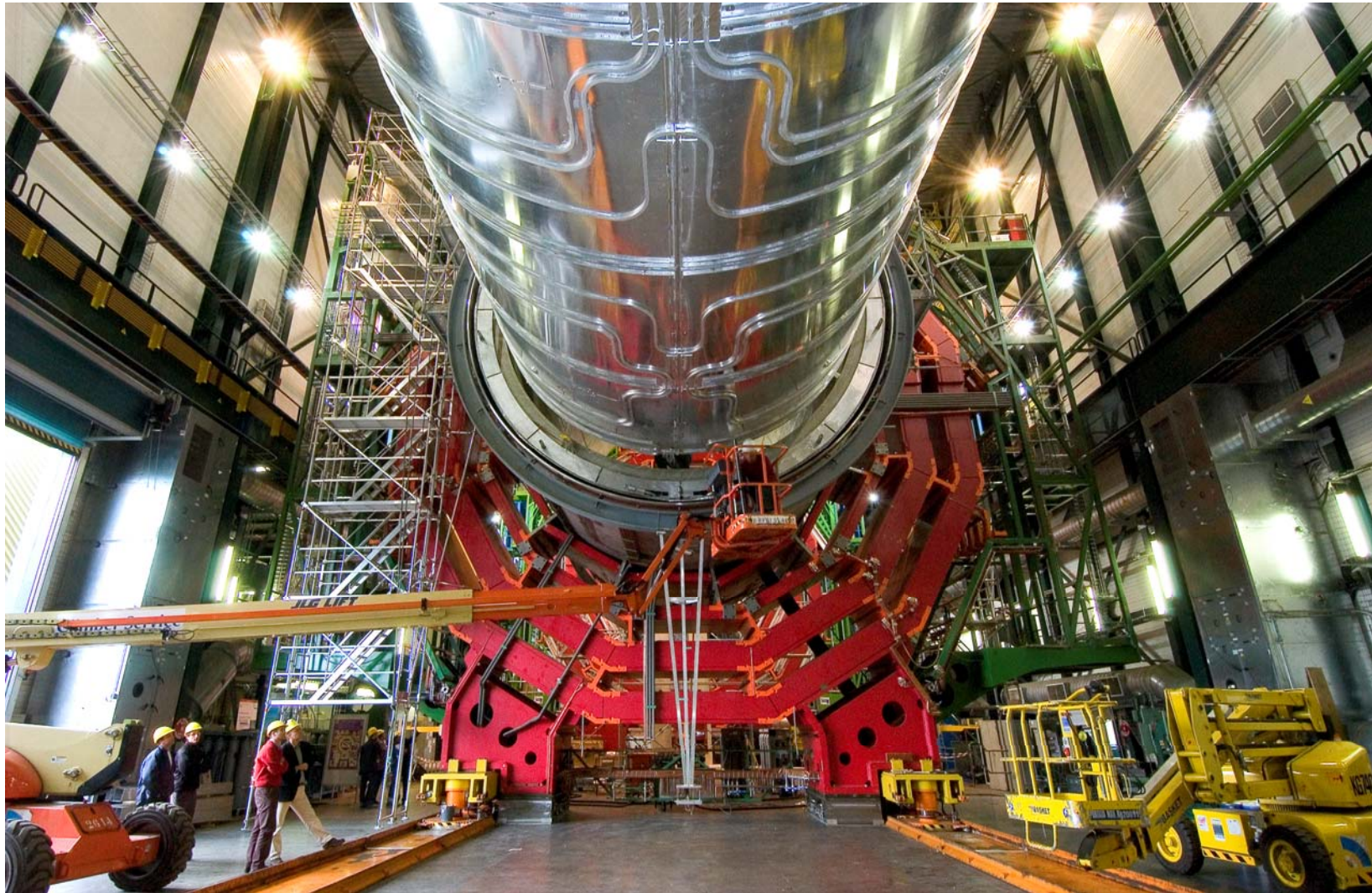



Dump resistors

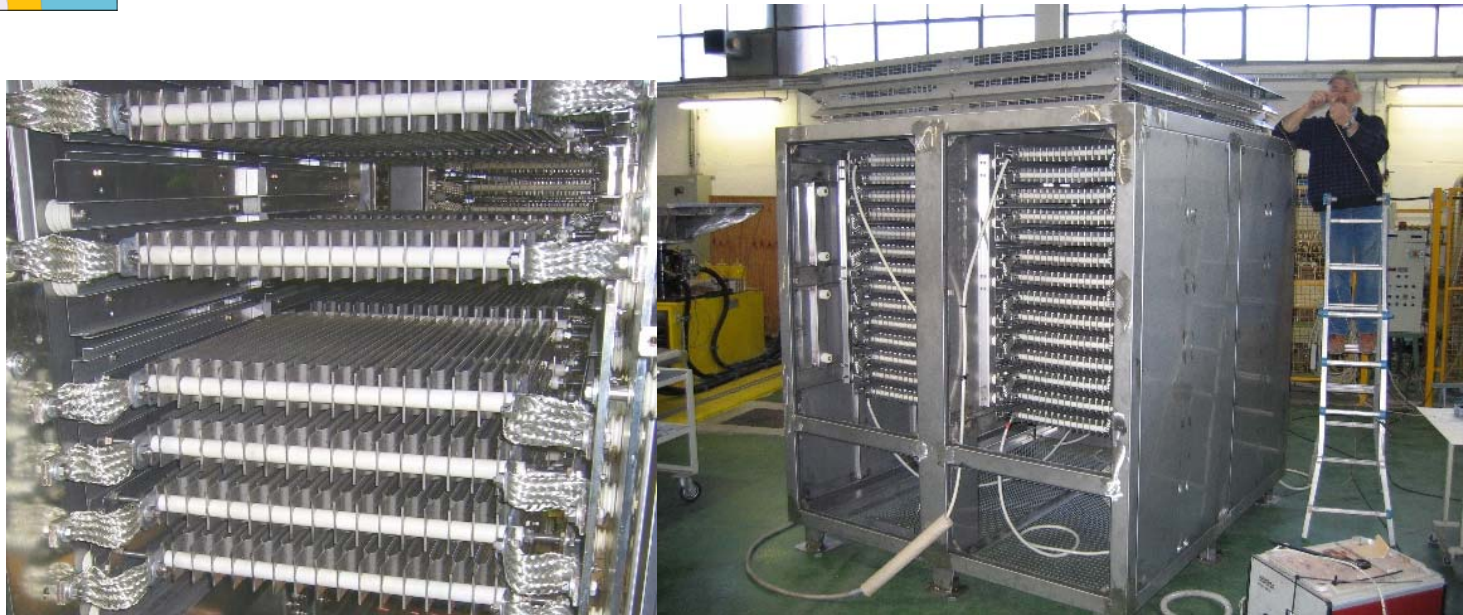



Cooling lay-out



Cooling lay-out at P5



Andrea Gaddi - PH/CMI

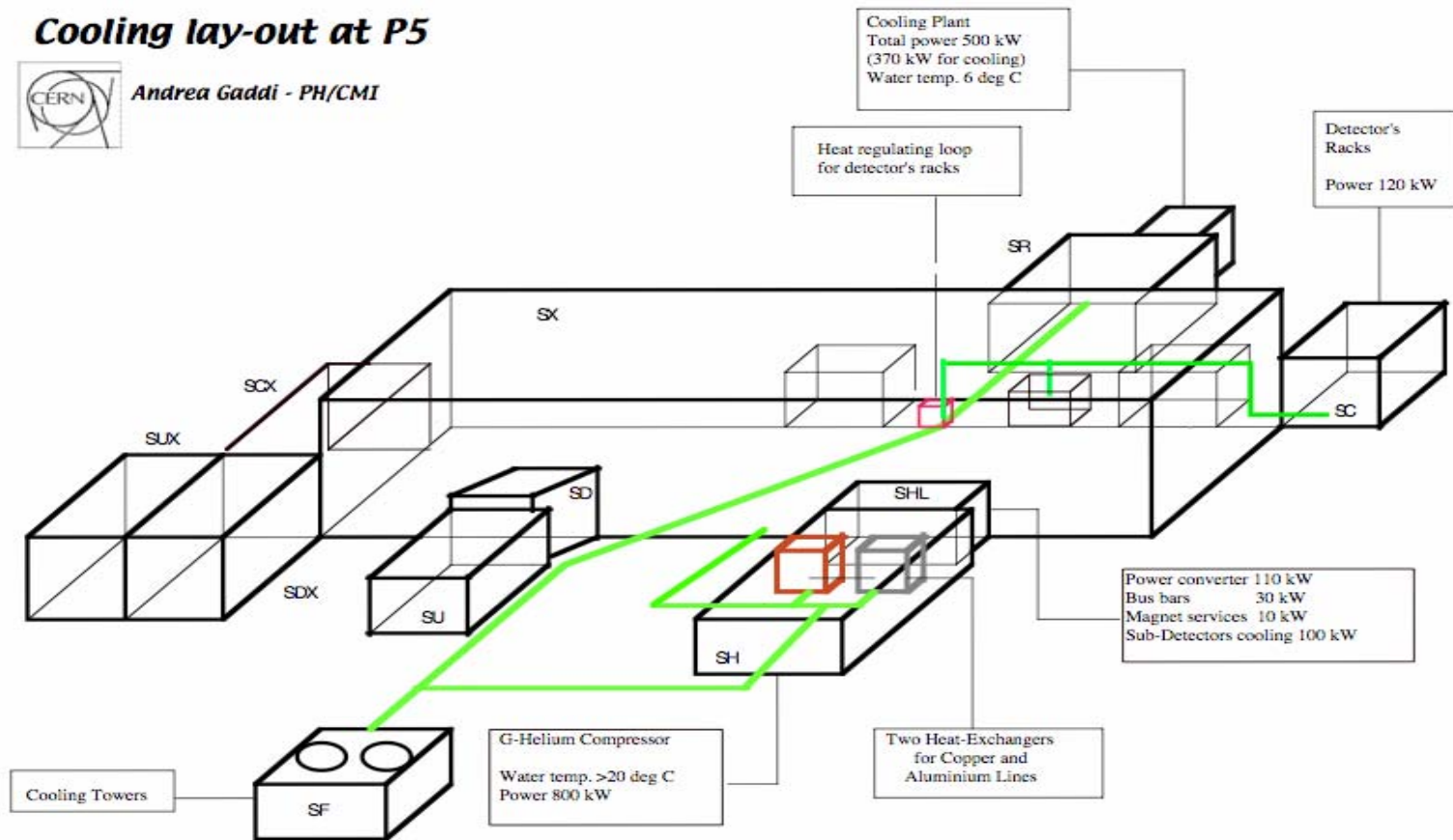



Some views of MCS PVSS supervisor screens



Magnet temperatures

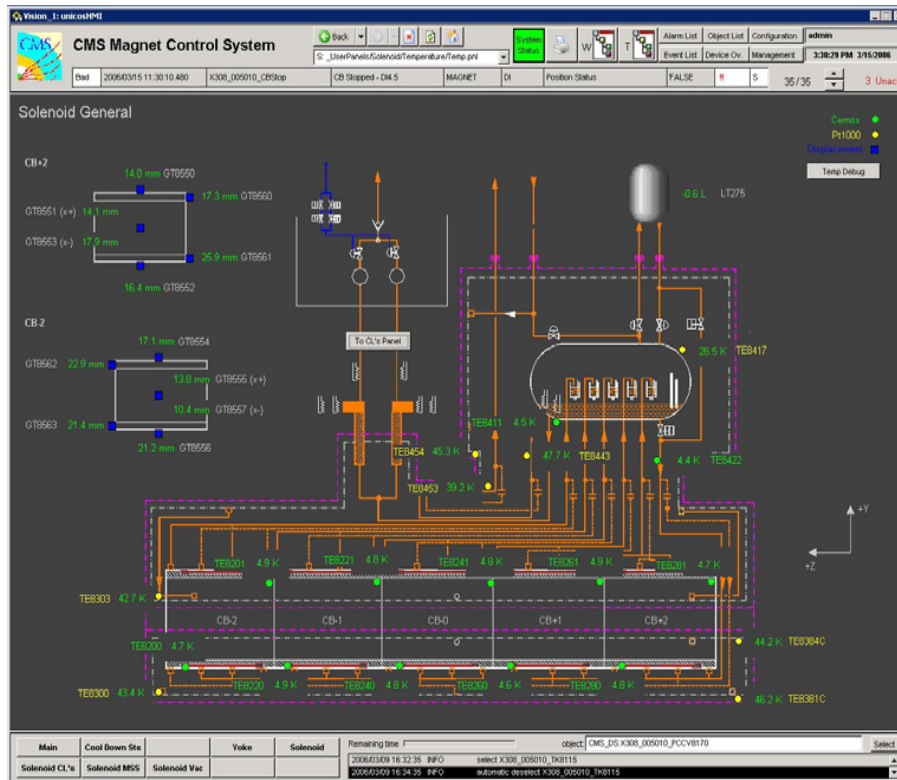

Vacuum pumping

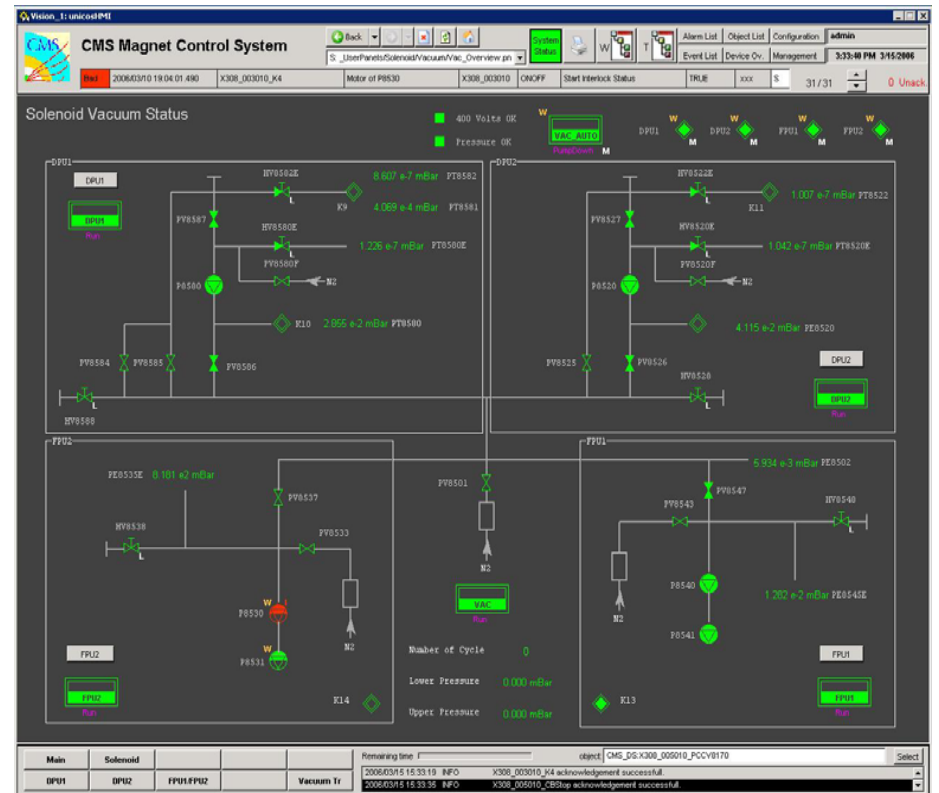



Provisional Control Room





FD Current Decays

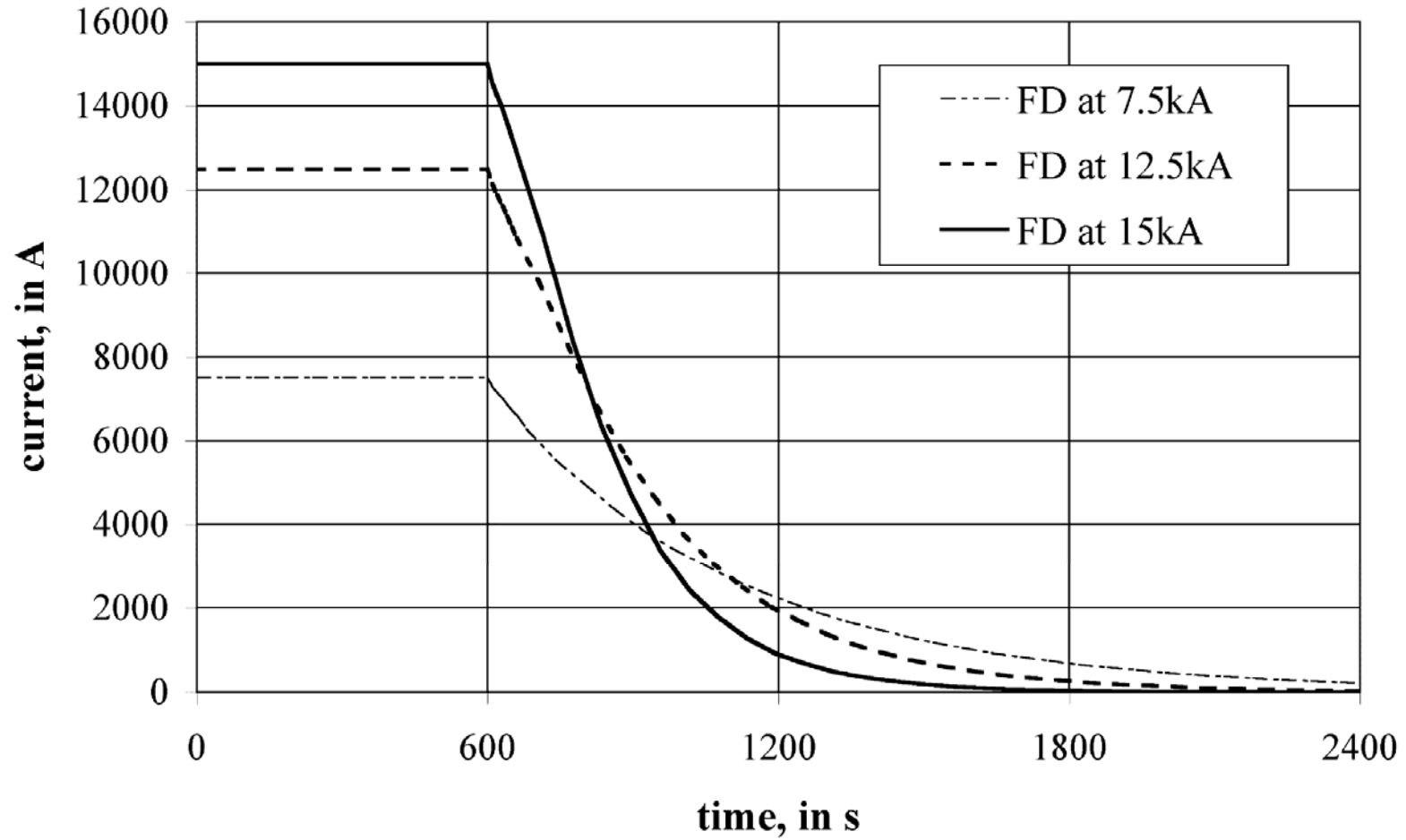



Air and grease pads system to move Magnet Elements





Endcap closing : minus side

