

# La relatività in dieci minuti

# Riassumendo

- Le leggi dell'elettromagnetismo sono invarianti rispetto alle trasformazioni (dette di Lorentz) per cui

$$c^2(t_A - t_B)^2 - (x_A - x_B)^2 = \text{invariante}$$

nella geometria di Euclide

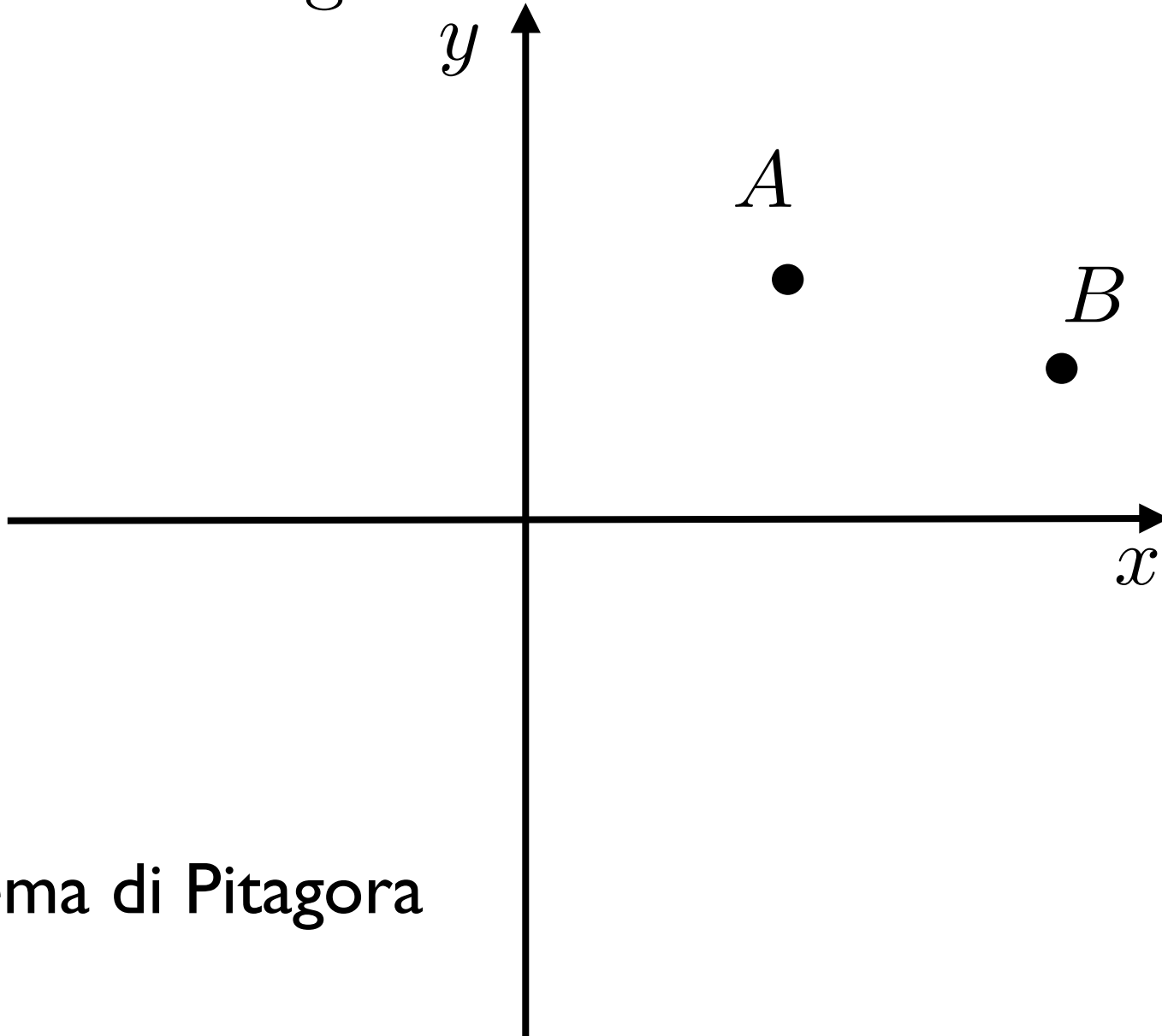

Teorema di Pitagora

$$(x_A - x_B)^2 + (y_A - y_B)^2 = \text{invariante}$$

nella geometria di Euclide

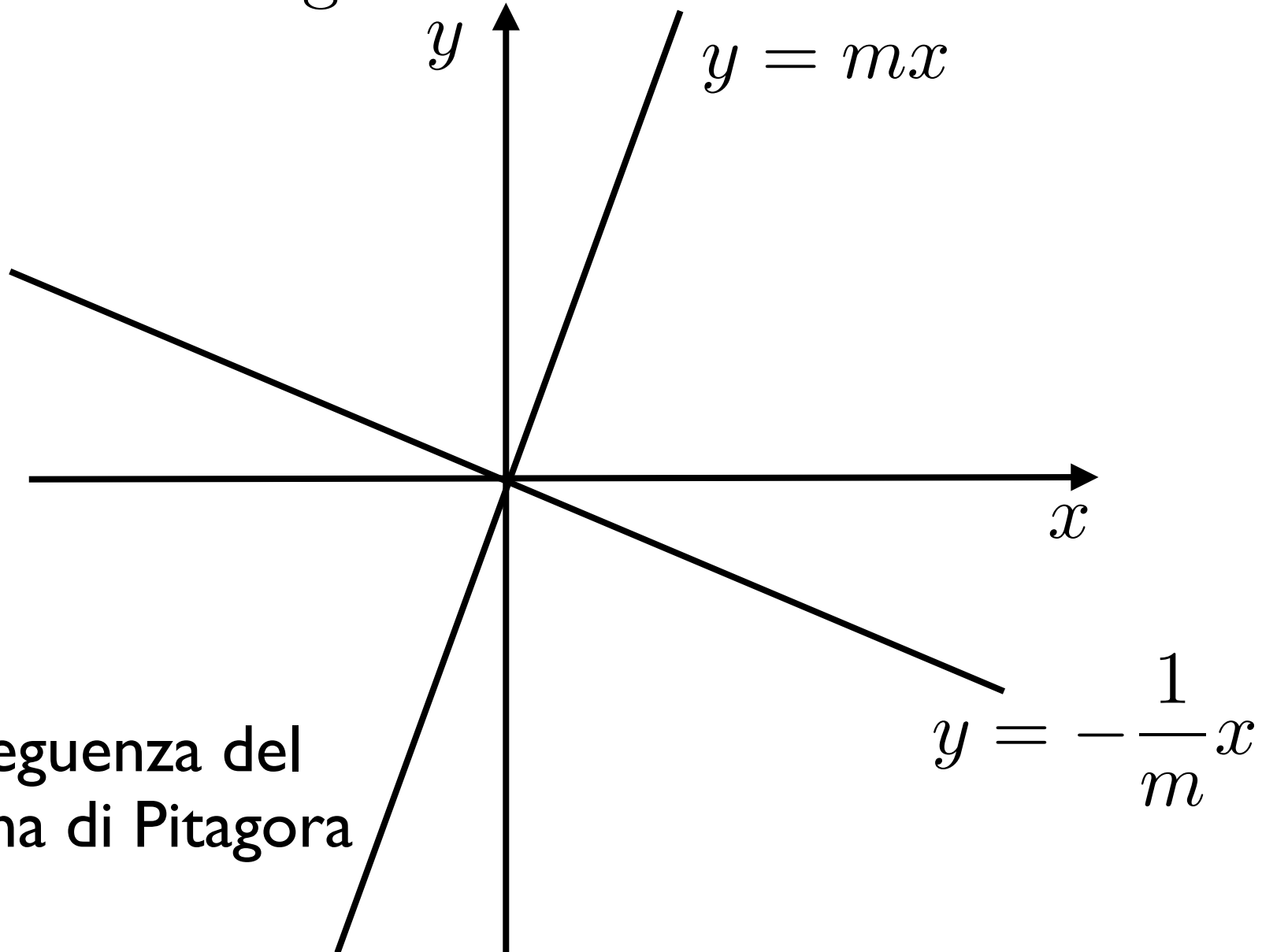

conseguenza del  
Teorema di Pitagora

rette ortogonali hanno pendenze inverse (o reciproche)  
e opposte (di segno opposto)  
rette parallele hanno la stessa pendenza

nella geometria di Minkowski

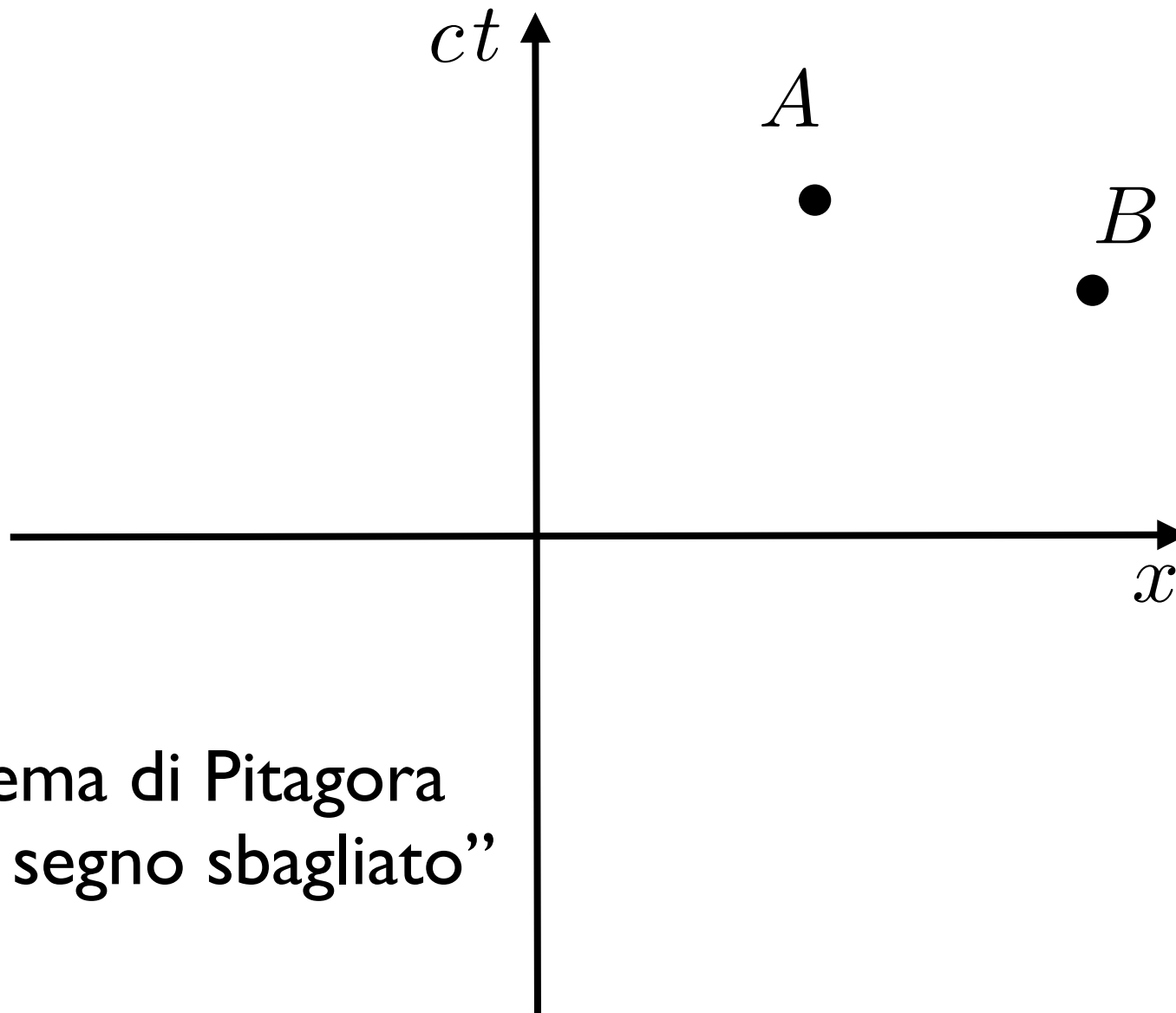

Teorema di Pitagora  
“con il segno sbagliato”

$$c^2 (t_A - t_B)^2 - (x_A - x_B)^2 = \text{invariante}$$

nella geometria di Minkowski

$$c^2(t_A - t_B)^2 - (x_A - x_B)^2 > 0 \quad \text{intervallo tipo-tempo}$$

$$c^2(t_A - t_B)^2 - (x_A - x_B)^2 = 0 \quad \text{intervallo tipo-nullo}$$

$$c^2(t_A - t_B)^2 - (x_A - x_B)^2 < 0 \quad \text{intervallo tipo-spazio}$$

# nella geometria di Minkowski

rette ortogonali hanno pendenze inverse (o reciproche)

**conseguenza del  
Teorema di Pitagora  
“con il segno sbagliato”**

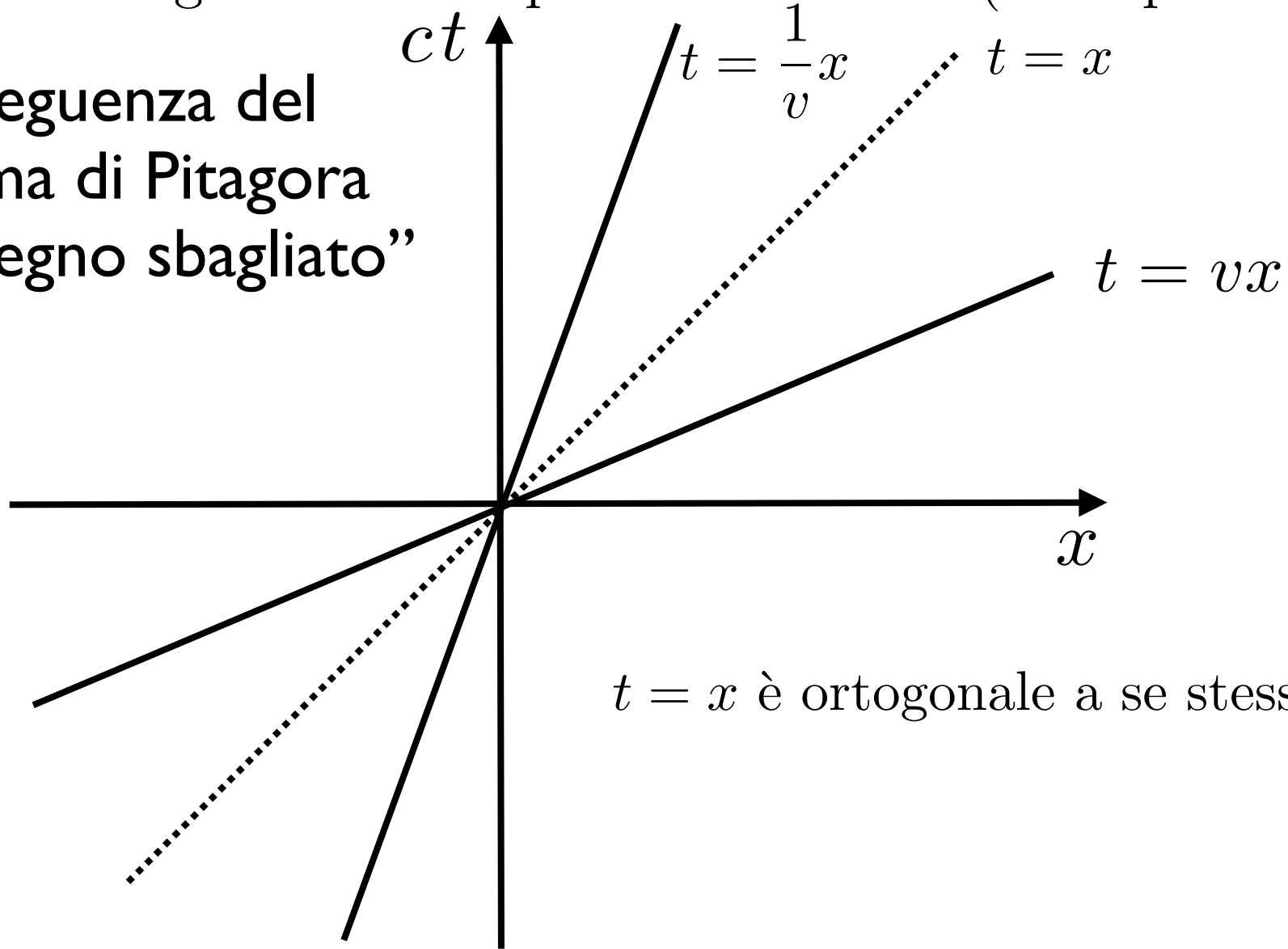

$t = x$  è ortogonale a se stessa

rette parallele hanno la stessa pendenza

Esempio:  $t = \frac{1}{v}x$   $t = \frac{1}{v}(x - x_0)$

# Trasformazioni di Lorentz

$$x' = \frac{x - vt}{\sqrt{1 - \frac{v^2}{c^2}}}$$

$$t' = \frac{t - \frac{vx}{c^2}}{\sqrt{1 - \frac{v^2}{c^2}}}$$



# La relatività in un'ora

linea di universo di  $K$

linea di universo di  $K'$

$K$  si muove con velocità  $v$  rispetto a  $K'$

$K'$  si muove con velocità  $-v$  rispetto a  $K$

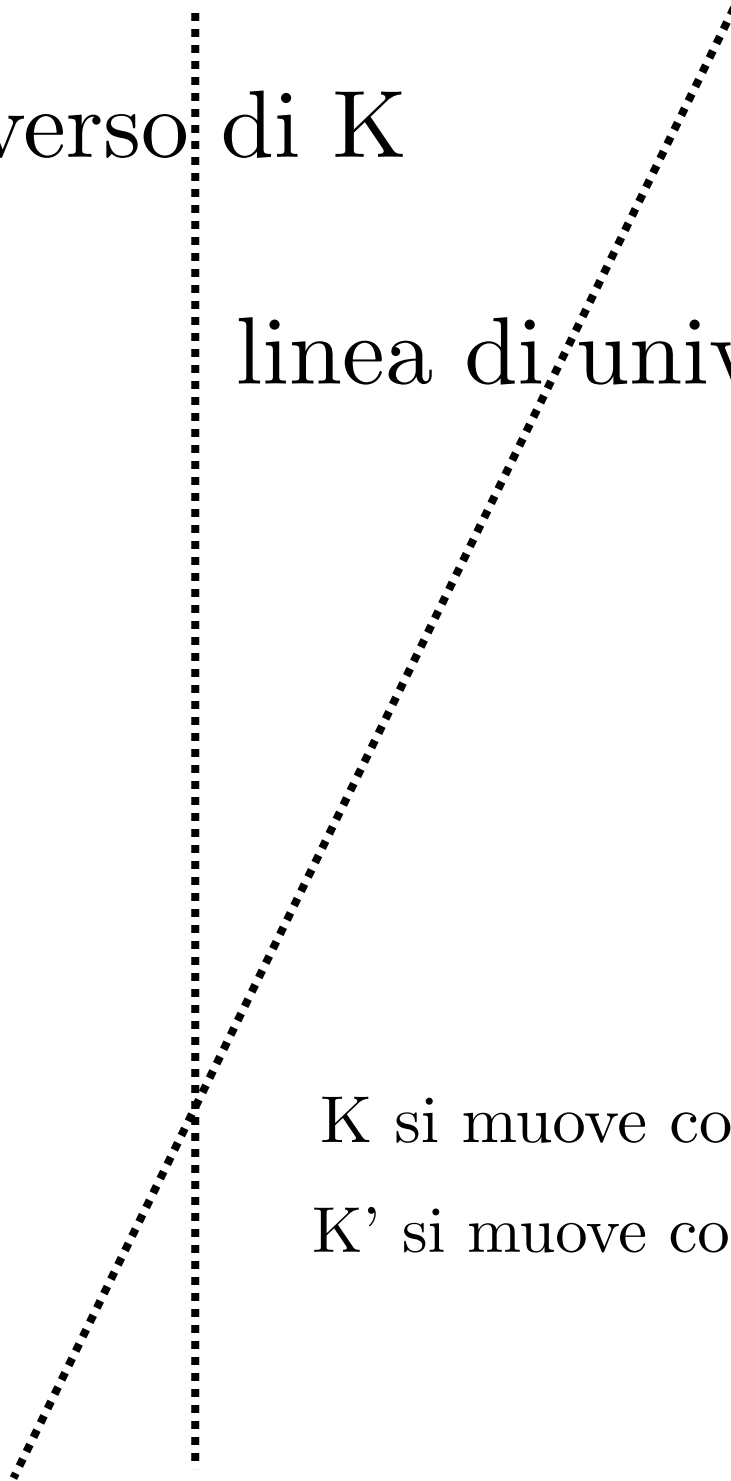

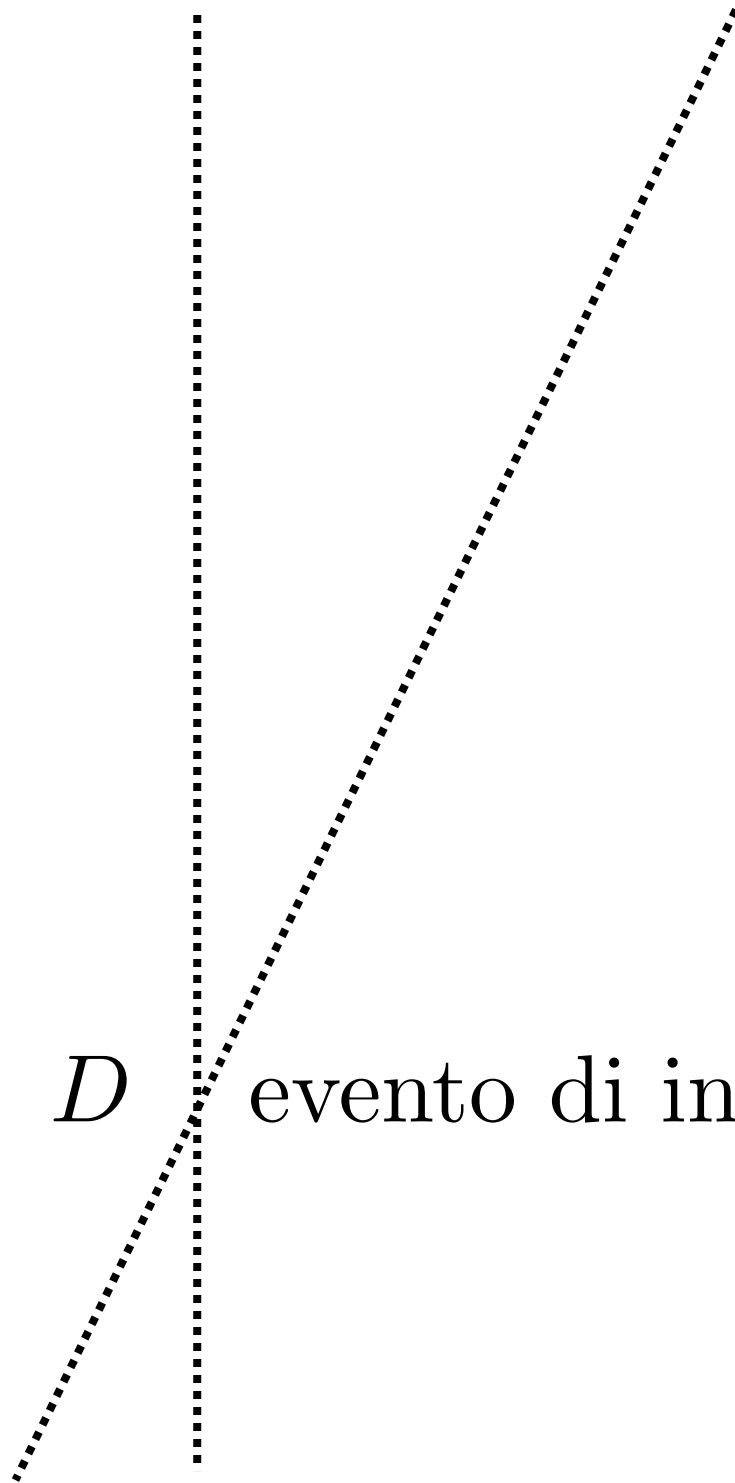

$D$  evento di incontro tra  $K$  e  $K'$

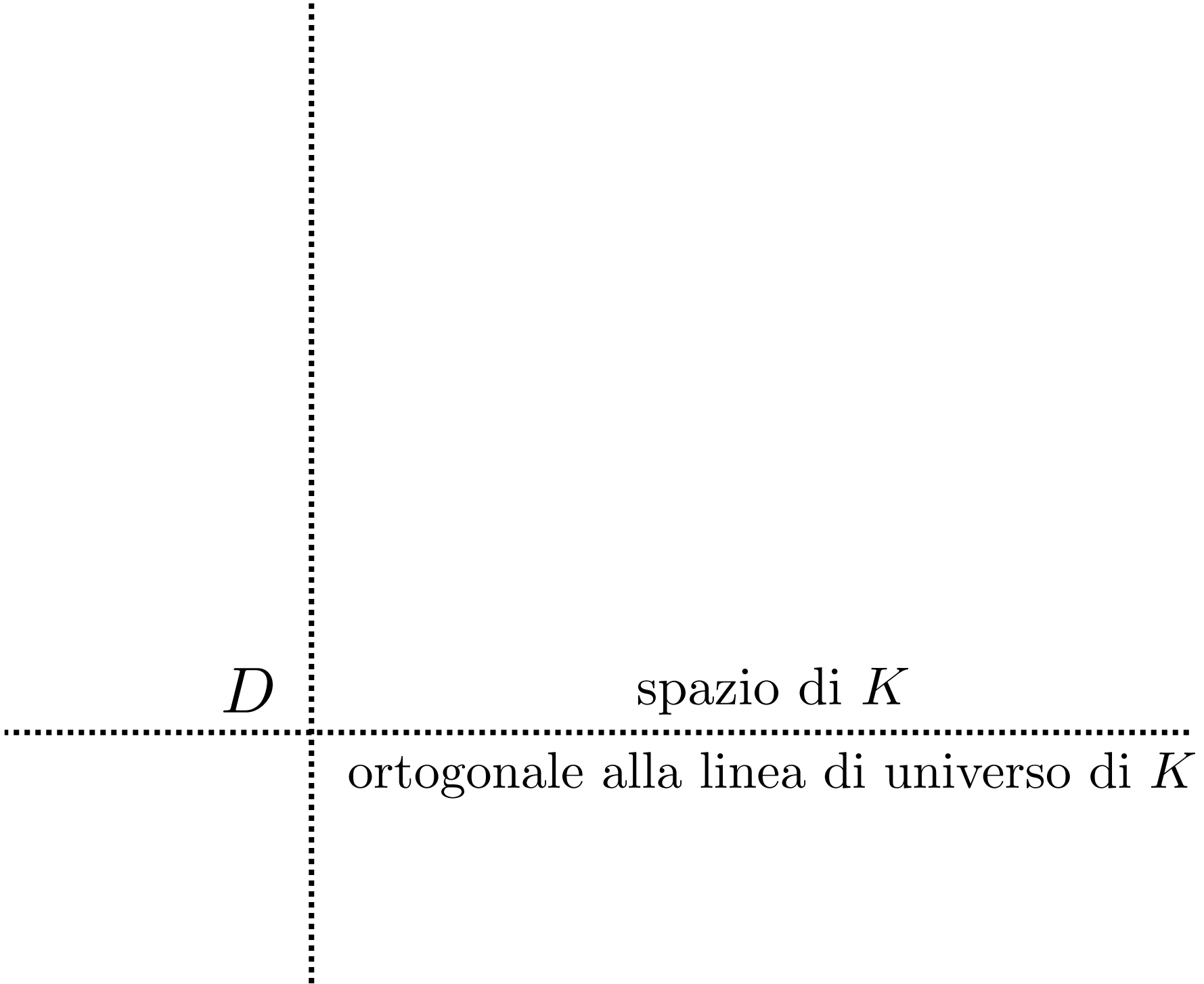

tempo di  $K$   
ortogonale allo spazio di  $K$

$D$



$\tilde{t}$  tempo misurato in secondi

$t$  misurato in metri

$$t = c\tilde{t}$$

$c$  fattore di conversione

$c$  ha le dimensioni di una velocità

quando il tempo si misura in metri le velocità sono numeri puri ( adimensionali)

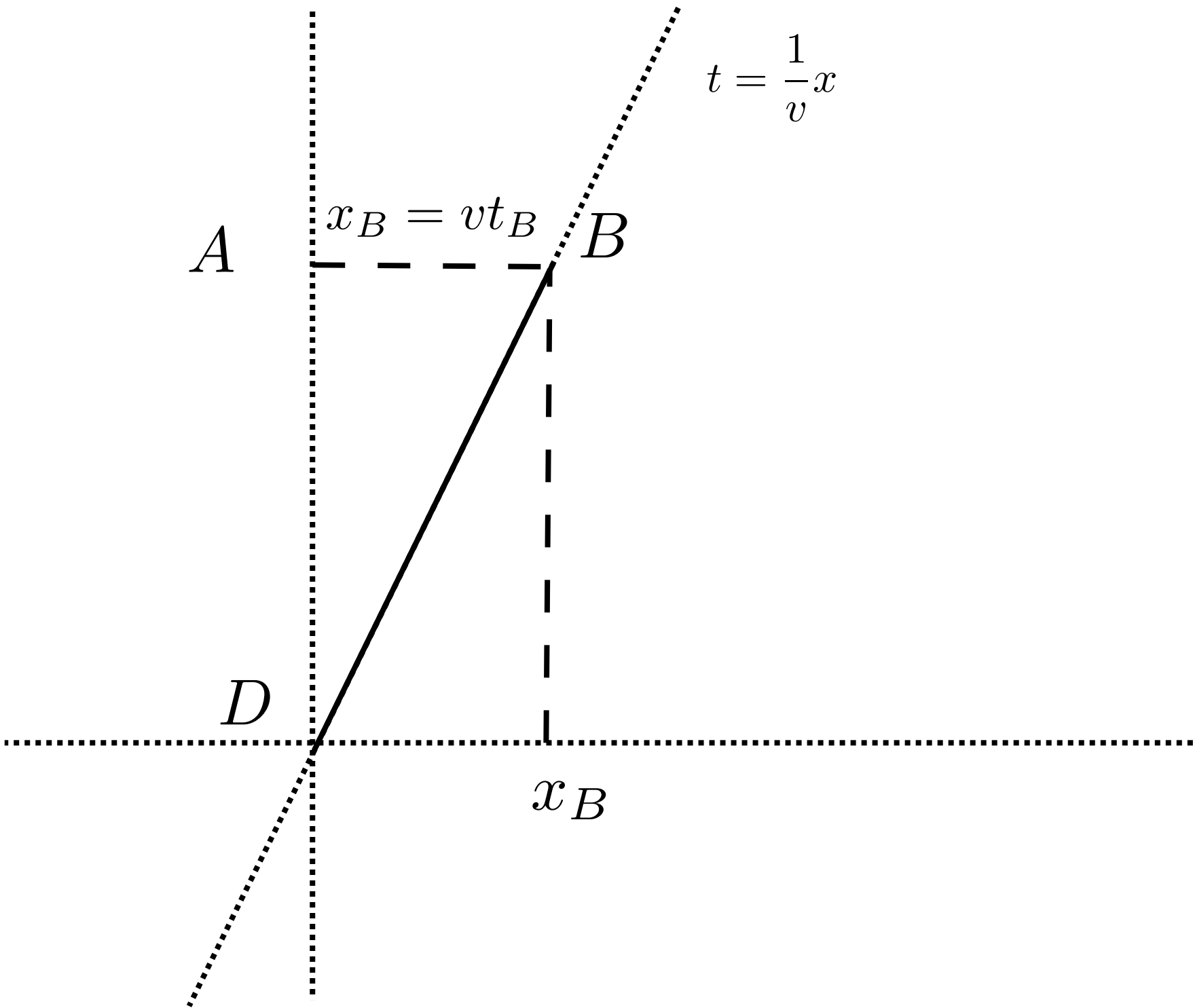

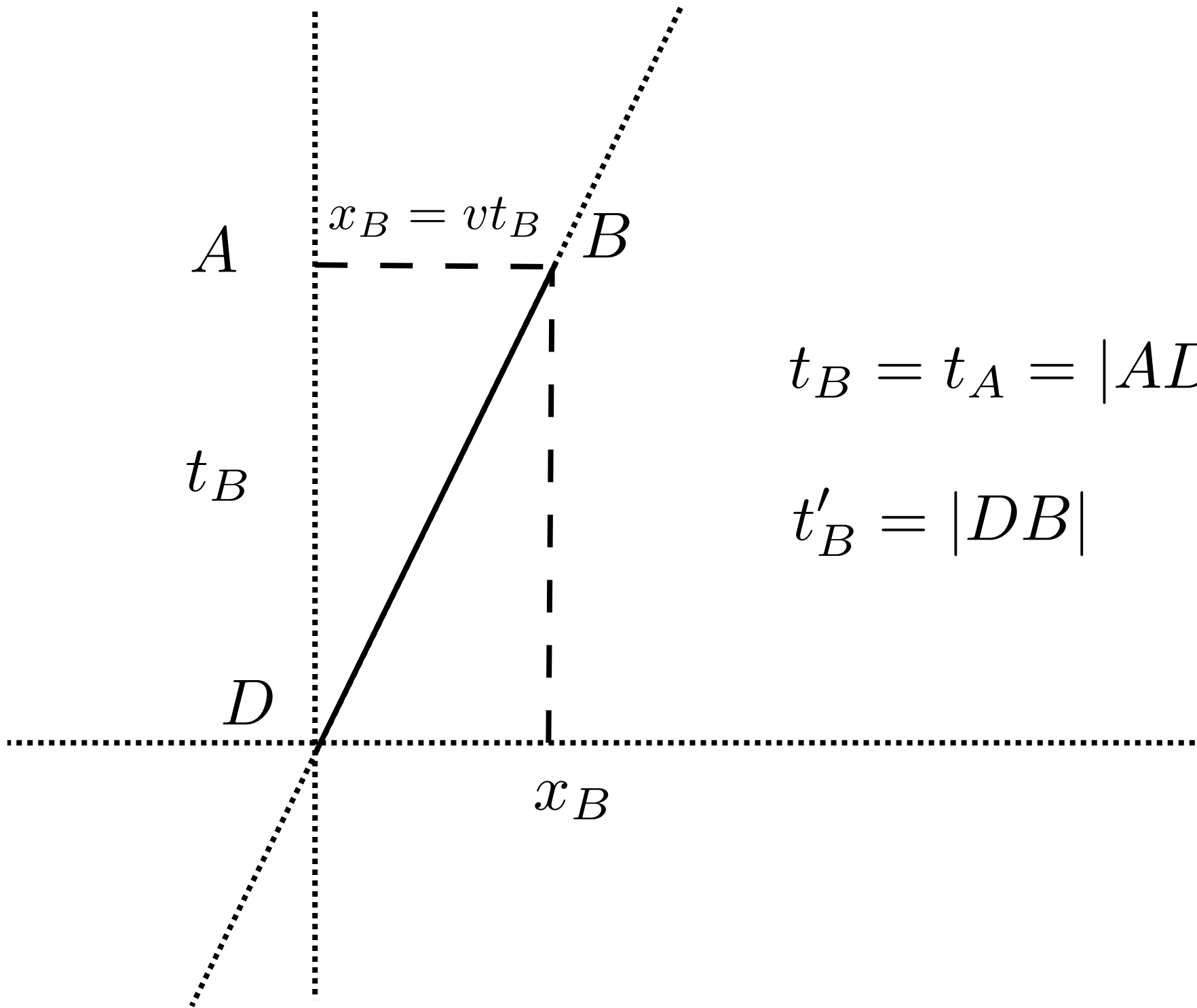



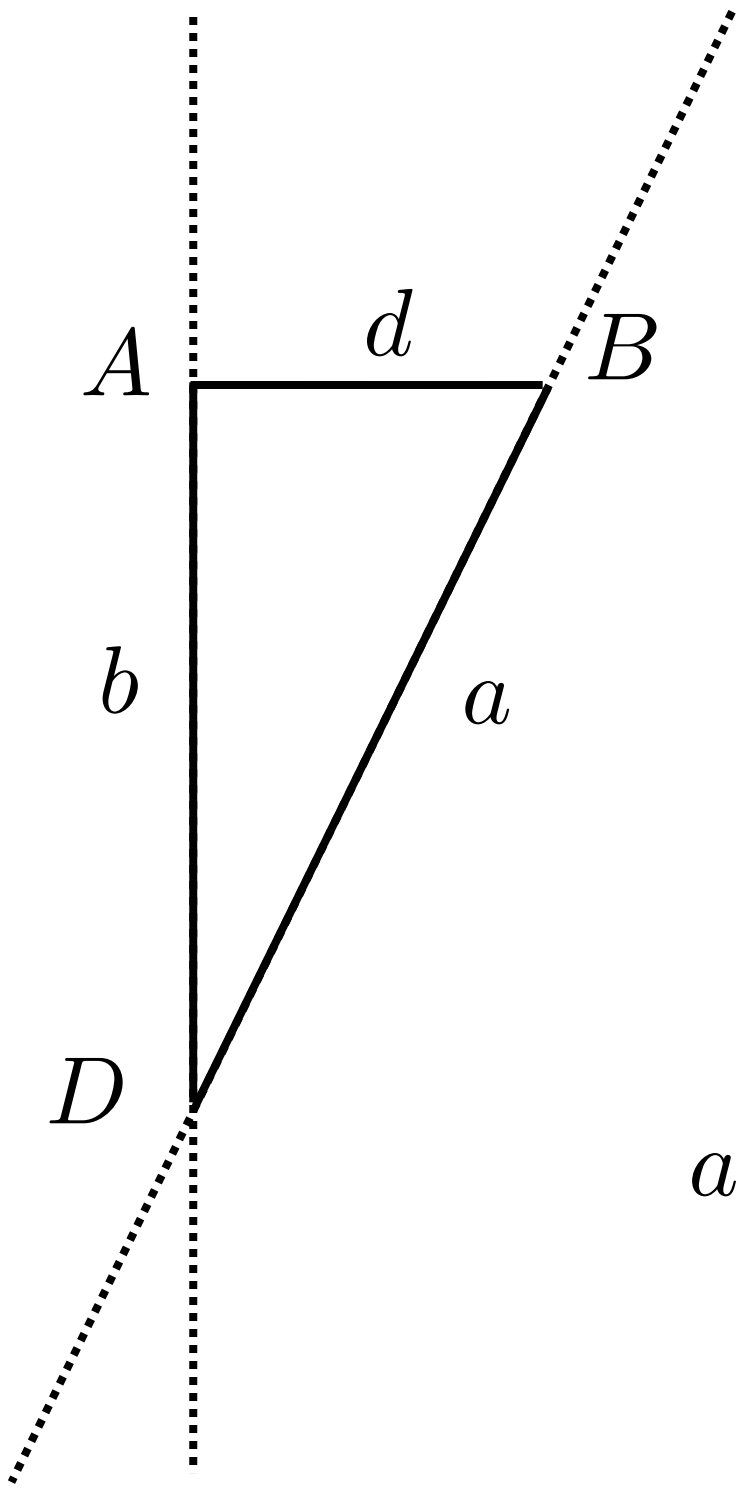

$$a^2 = b^2 - d^2$$

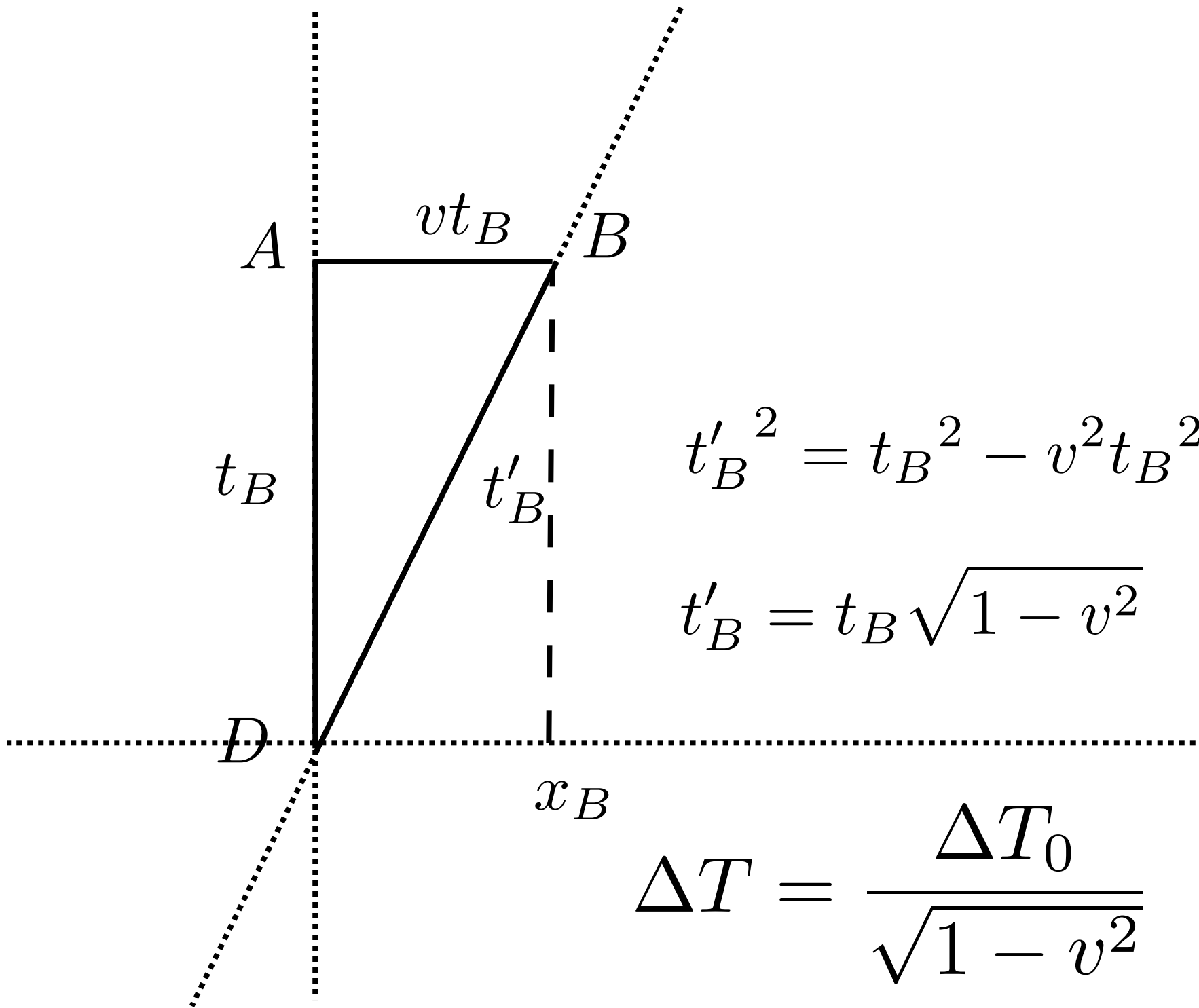

# Paradosso dei gemelli

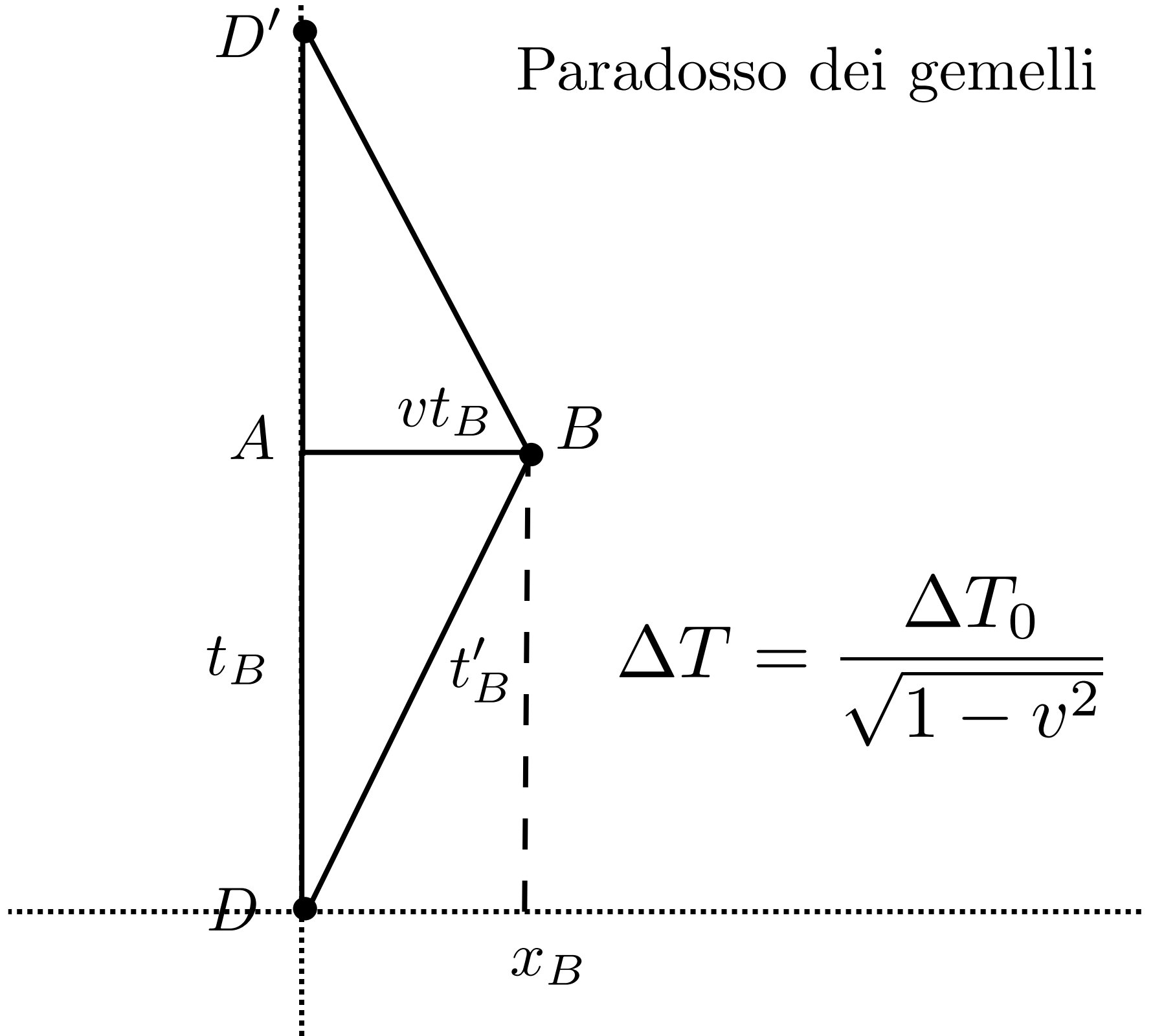

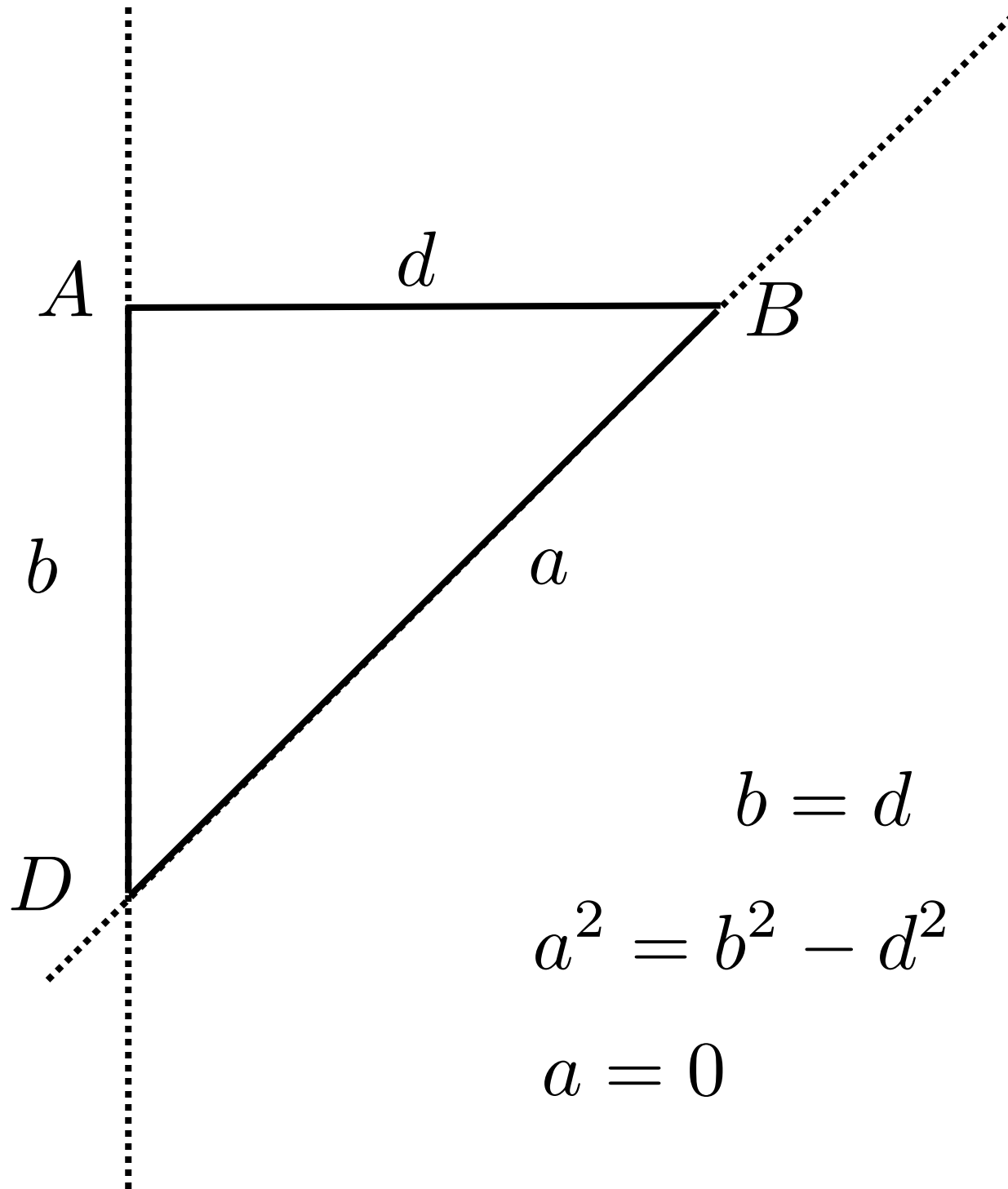

tempo di  $K$

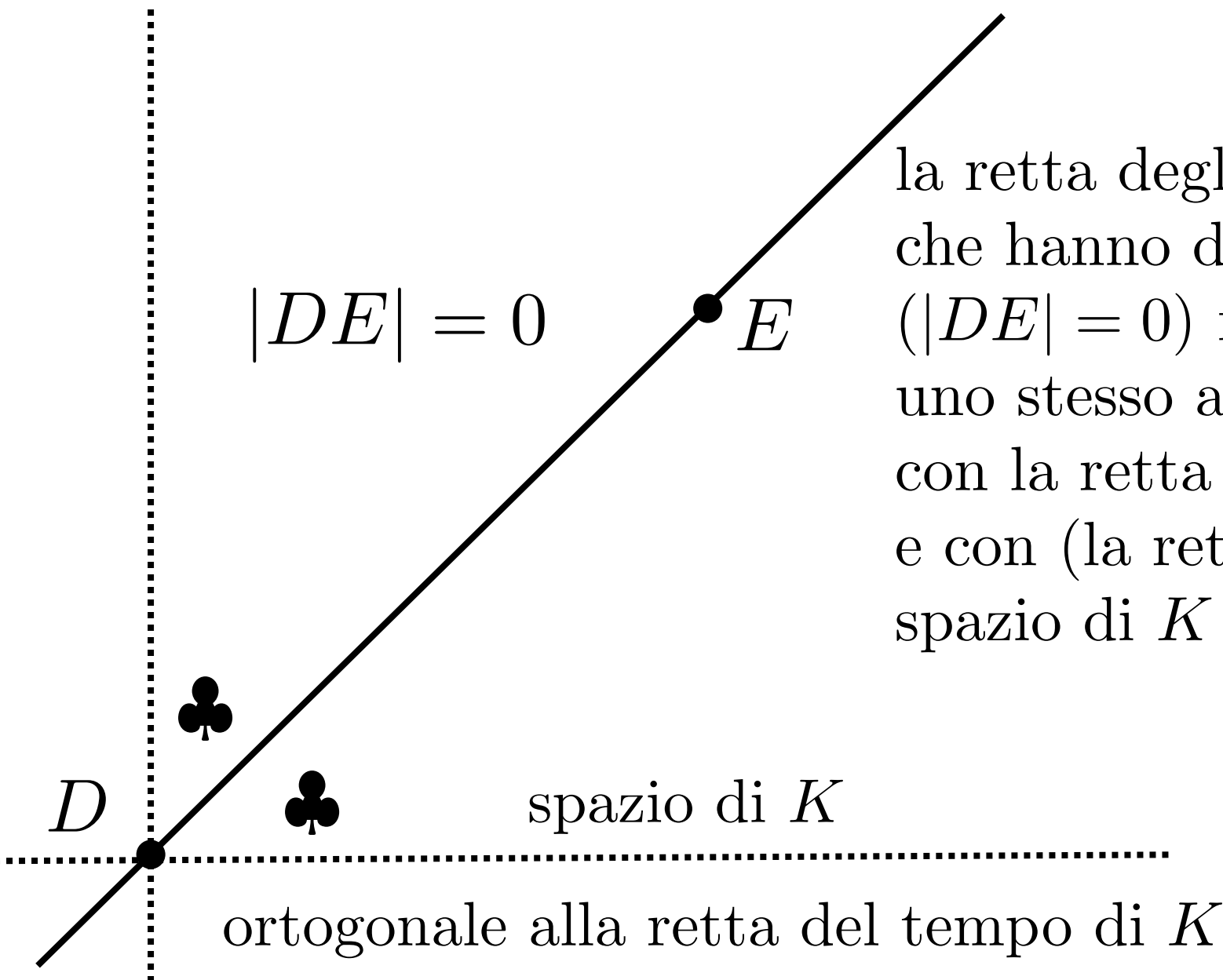

la retta degli eventi  
che hanno distanza 0 da  $D$   
( $|DE| = 0$ ) forma  
uno stesso angolo ♣  
con la retta del tempo di  $K$   
e con (la retta del)lo  
spazio di  $K$

lo stesso deve accadere per  $K'$

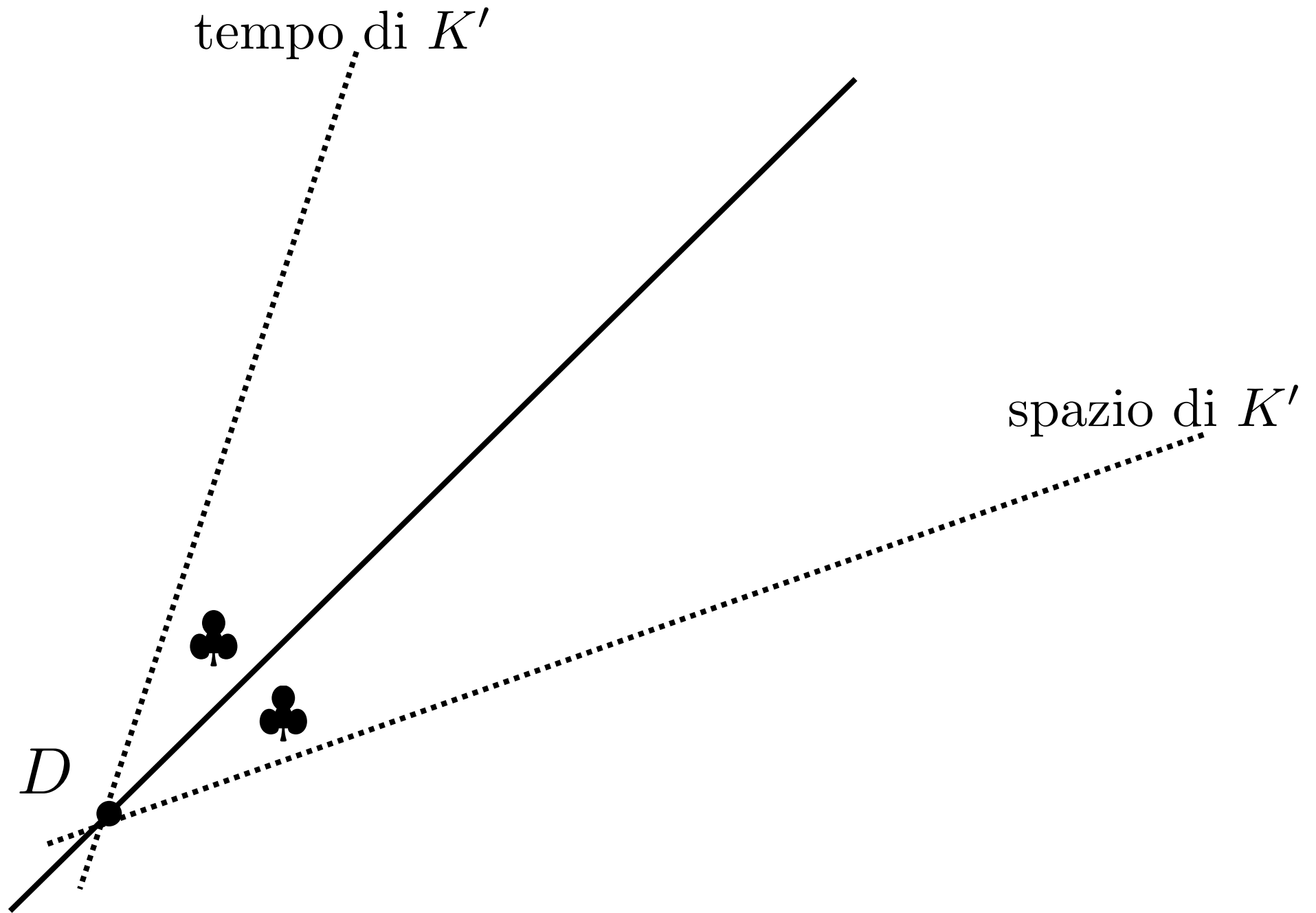

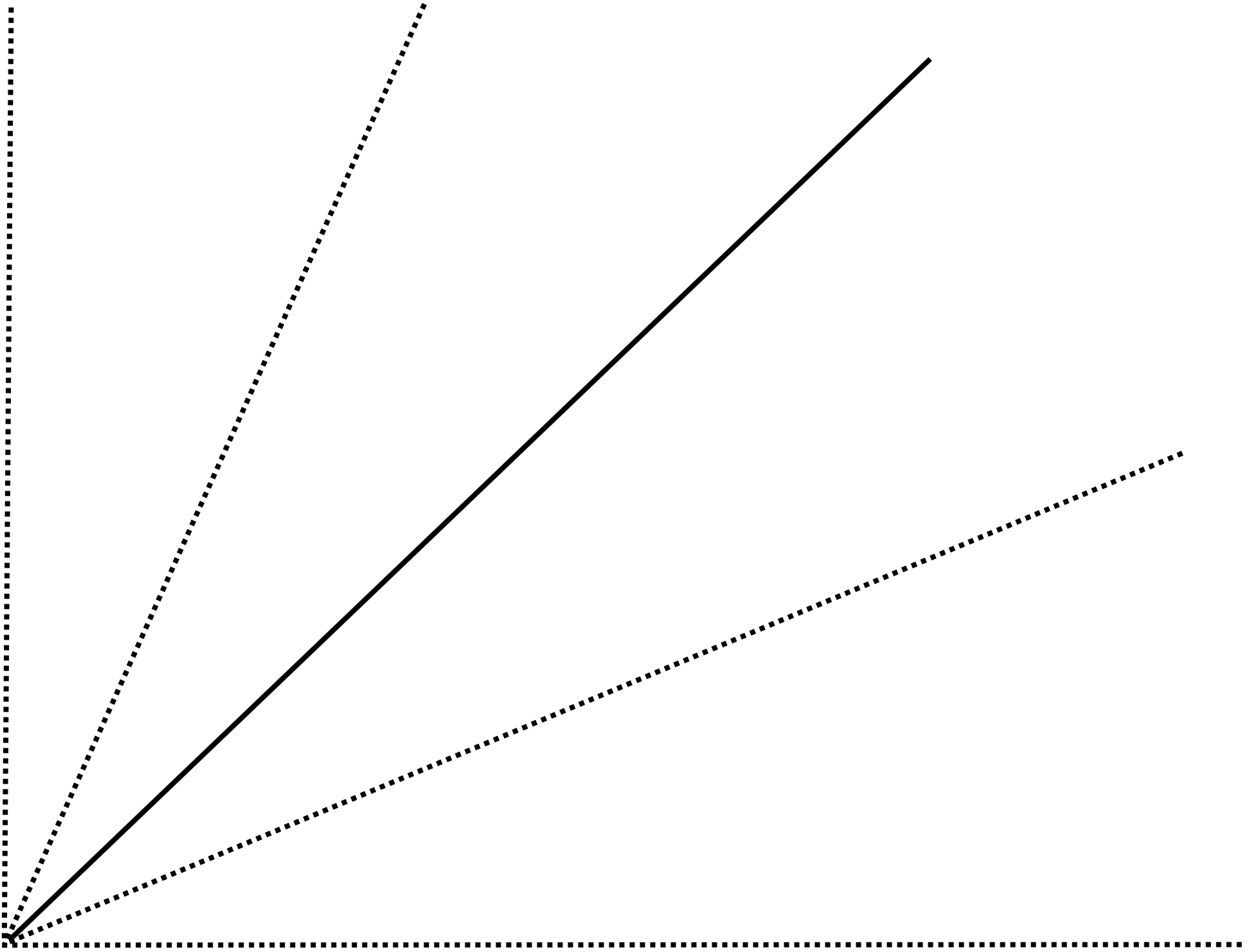

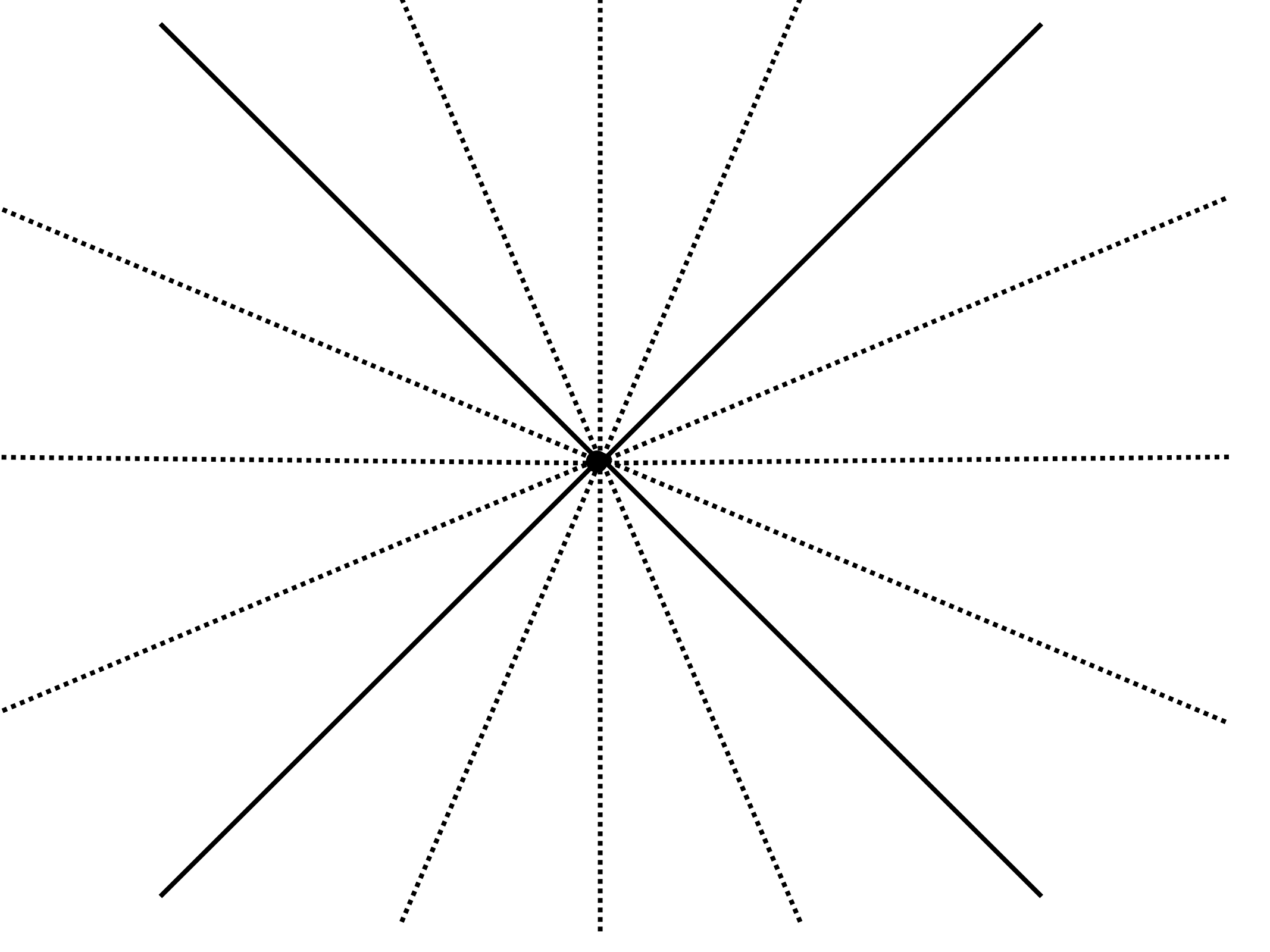



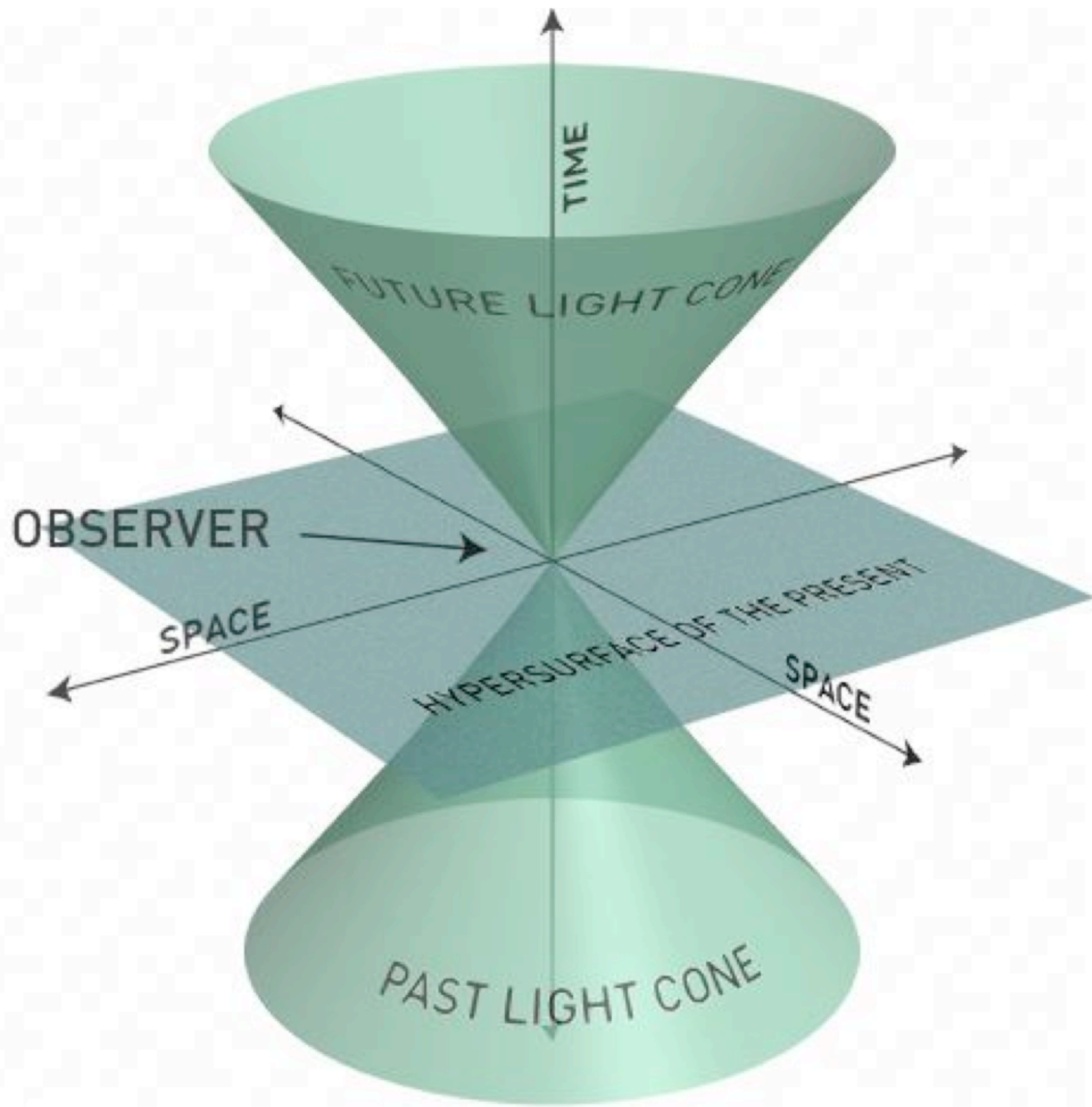

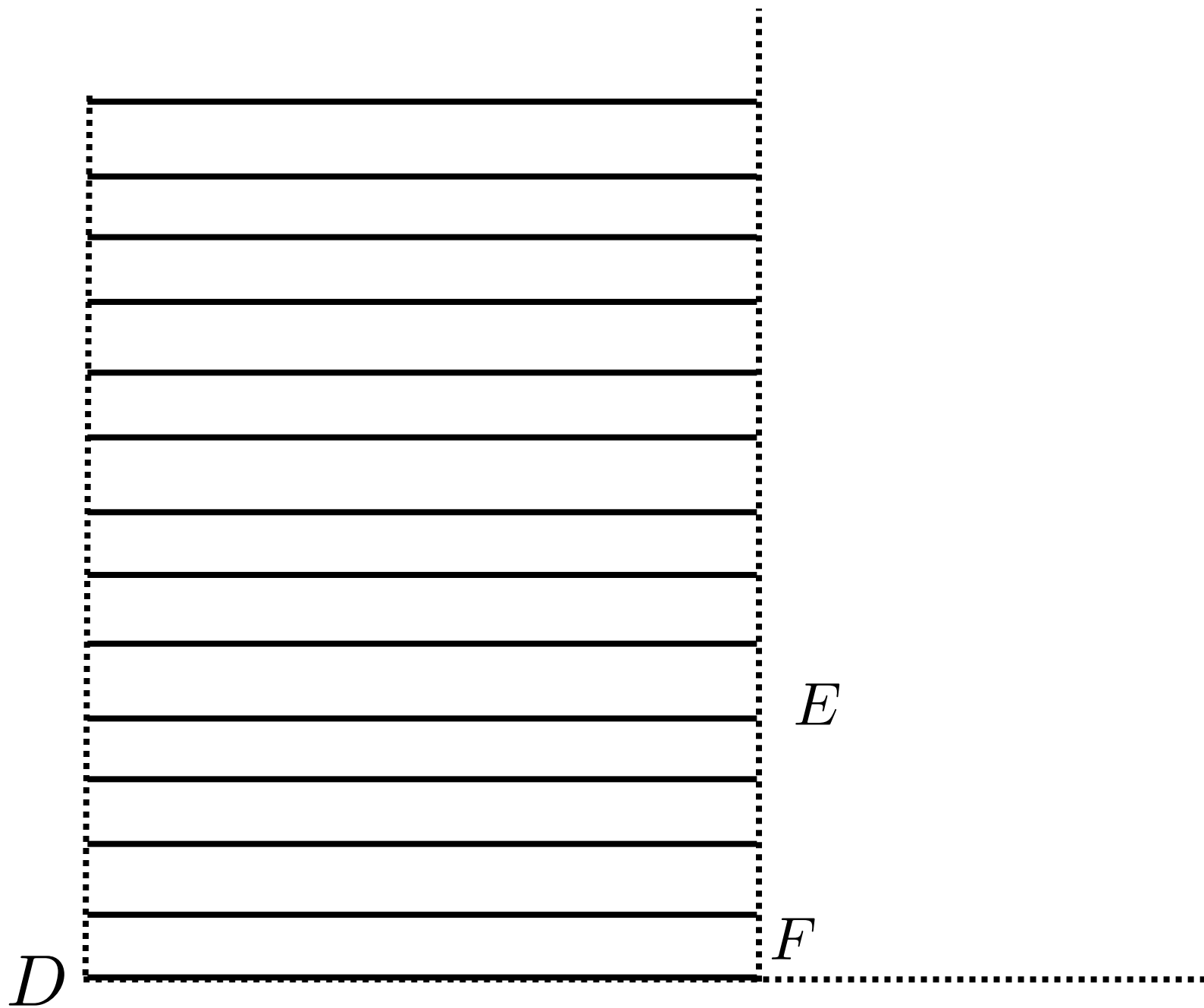

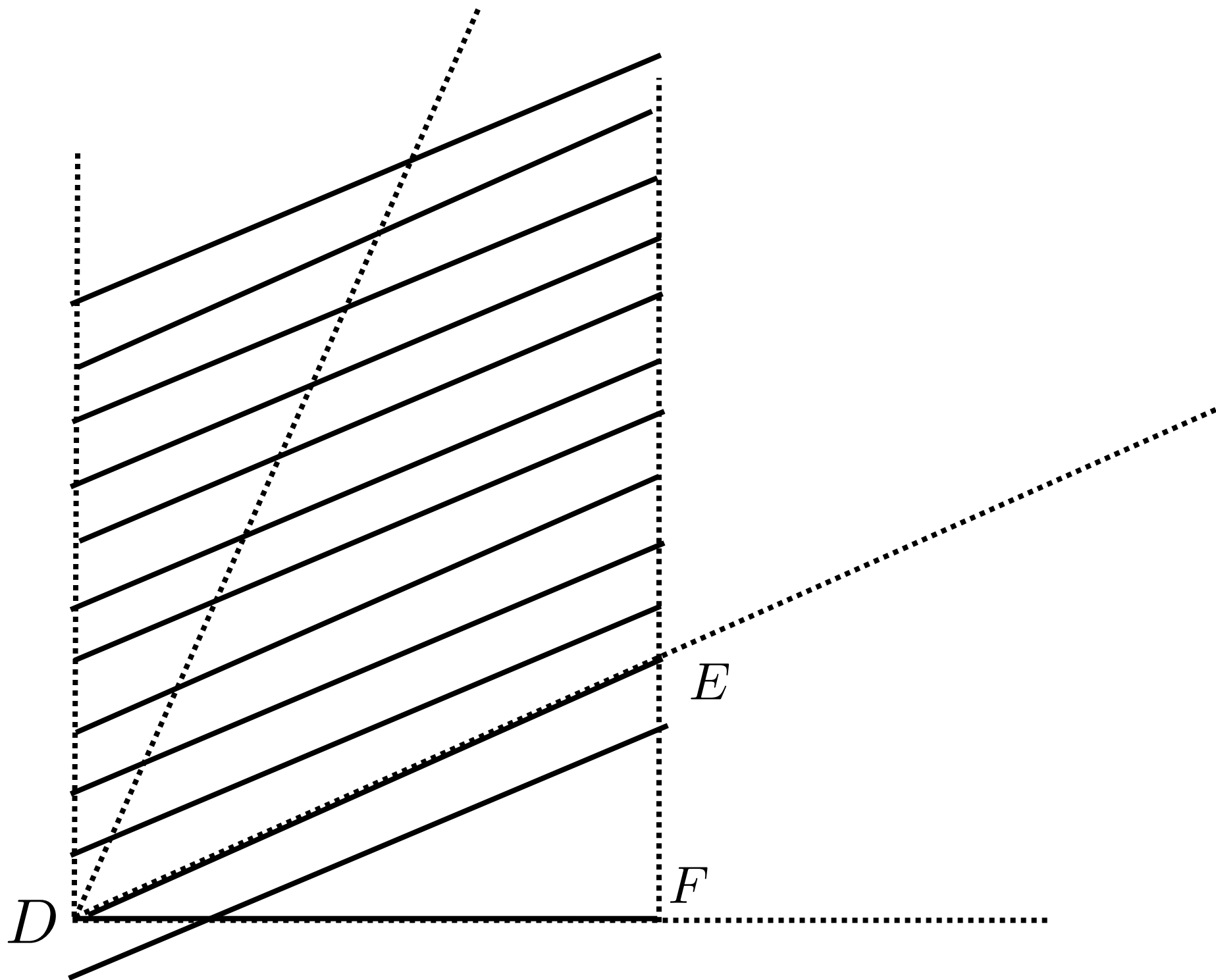

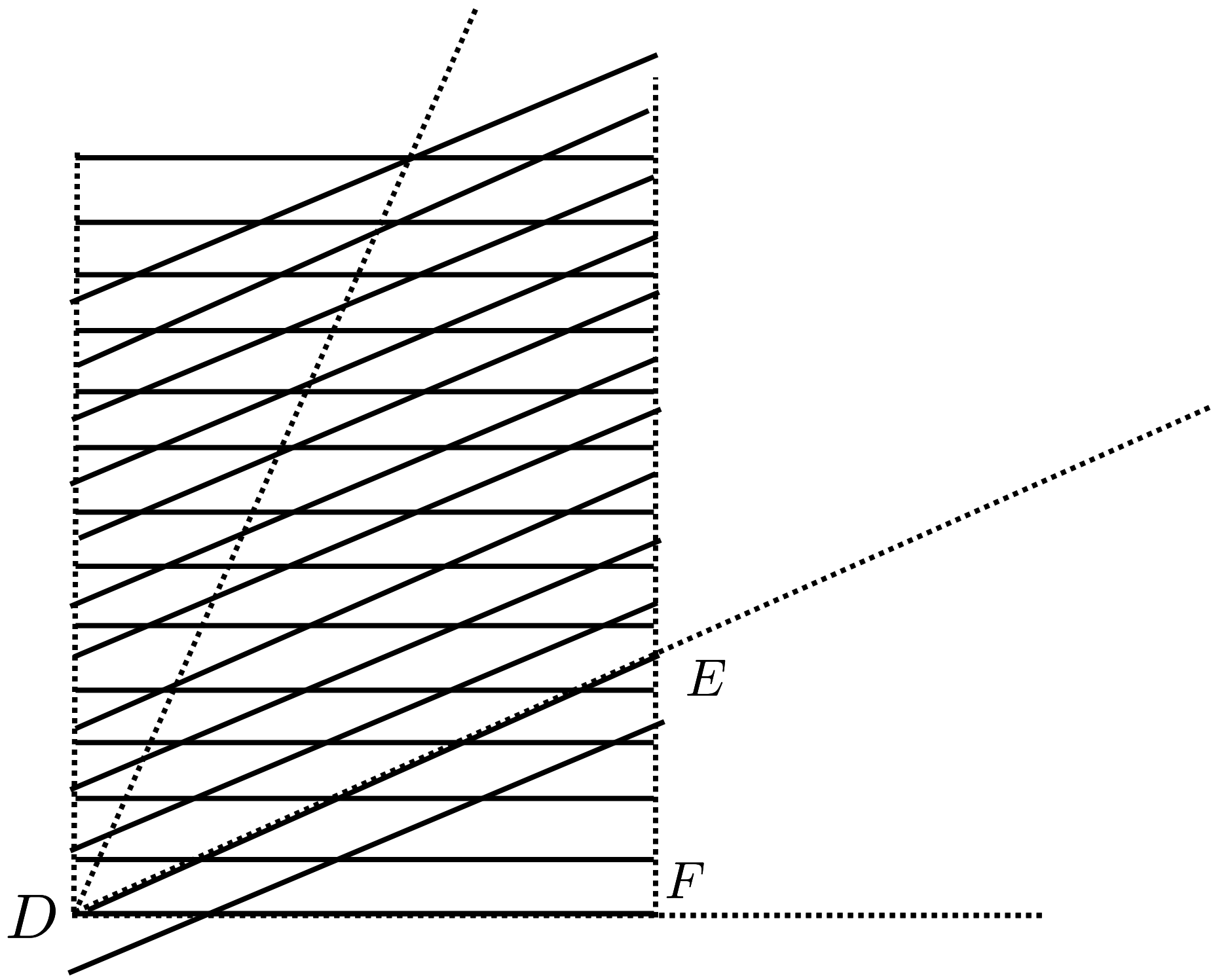

triangoli rettangoli simili

$$\frac{|AB|}{|AD|} = \frac{|DF|}{|EF|}$$

$$v = \frac{|DF|}{|EF|}$$

$$|EF| = v|DF|$$

$$|DF| \equiv L_0$$

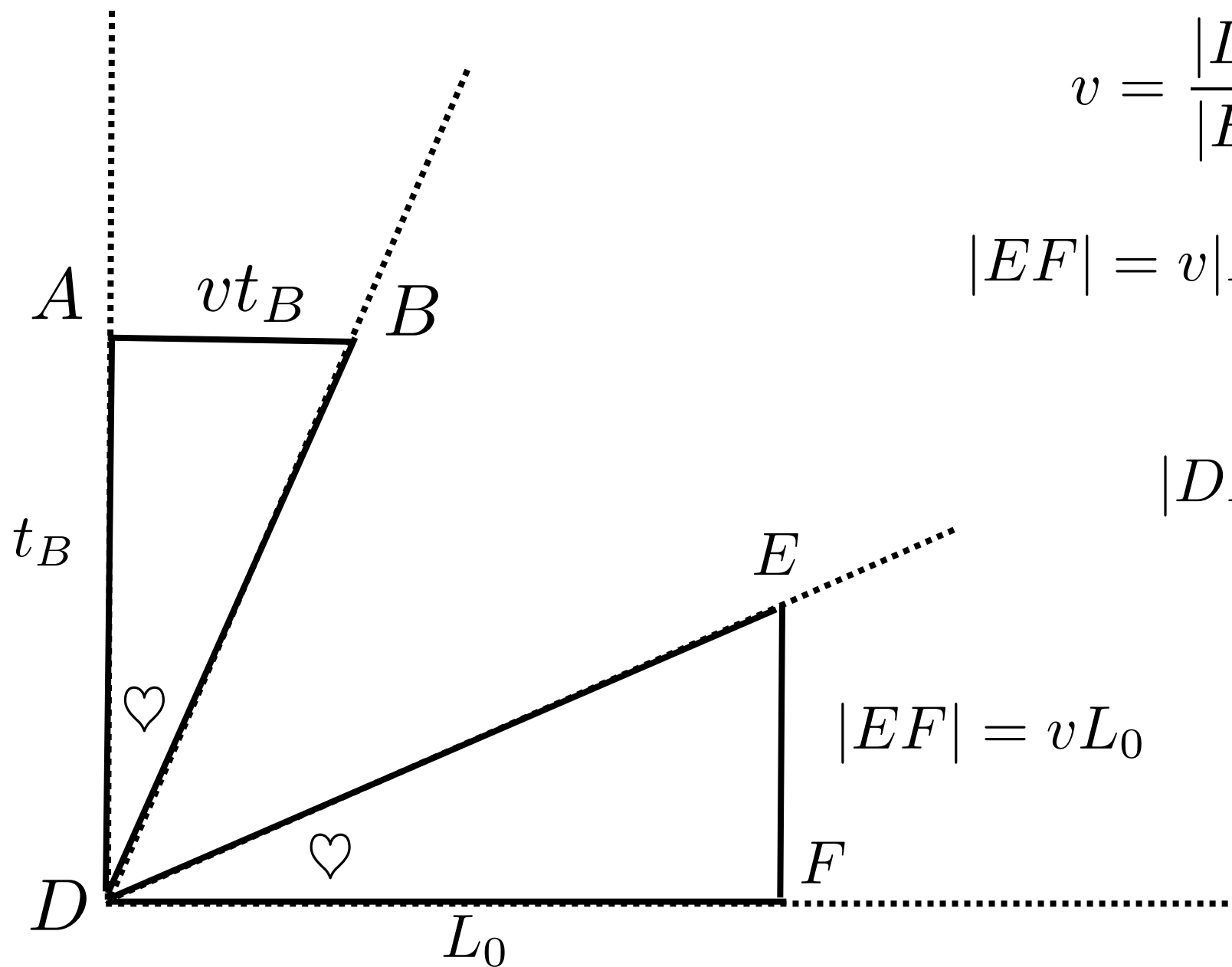

$$|EF| = vL_0$$

$$|DE| \equiv L$$

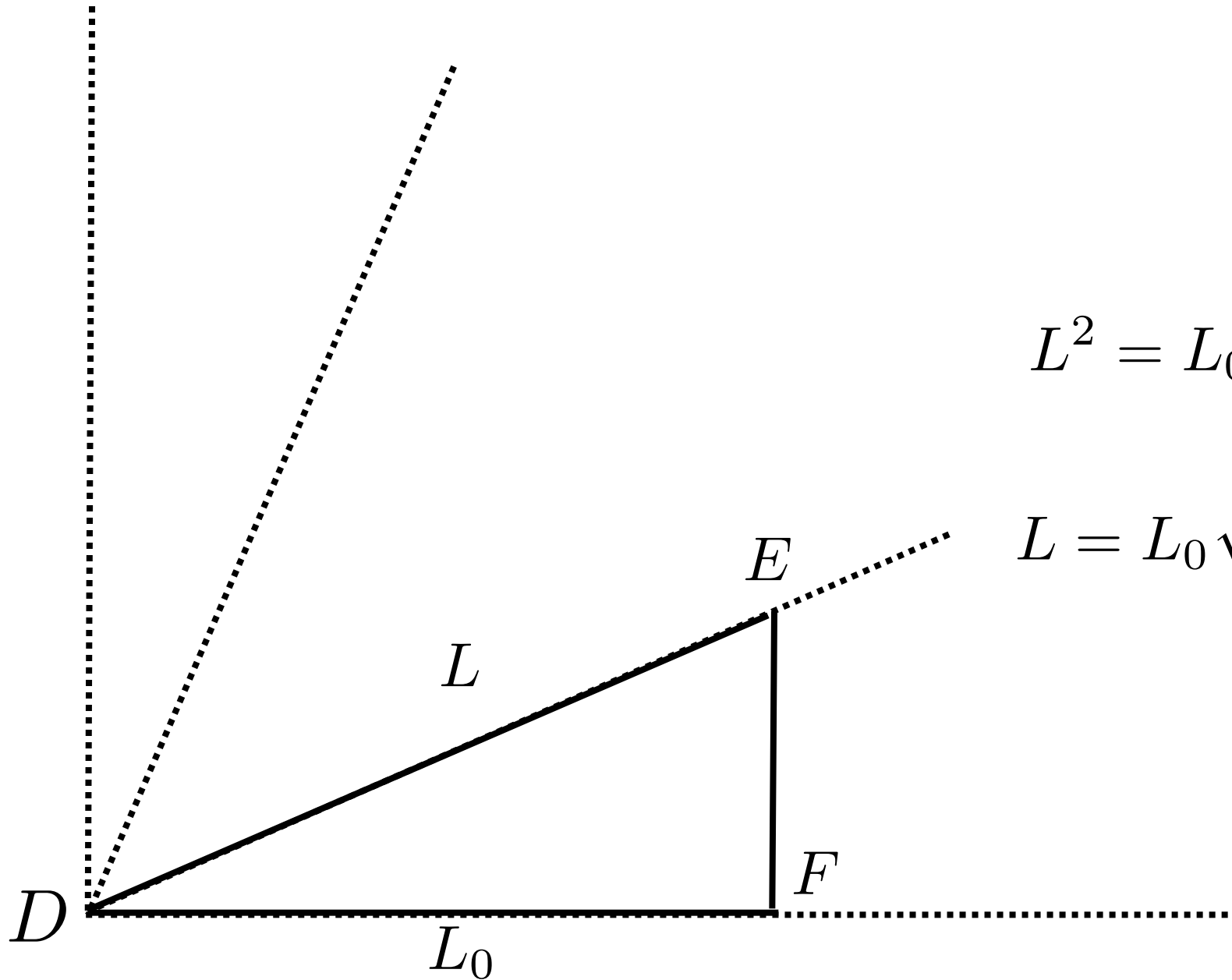

$$L^2 = L_0^2 - v^2 L_0^2$$

$$L = L_0 \sqrt{1 - v^2}$$



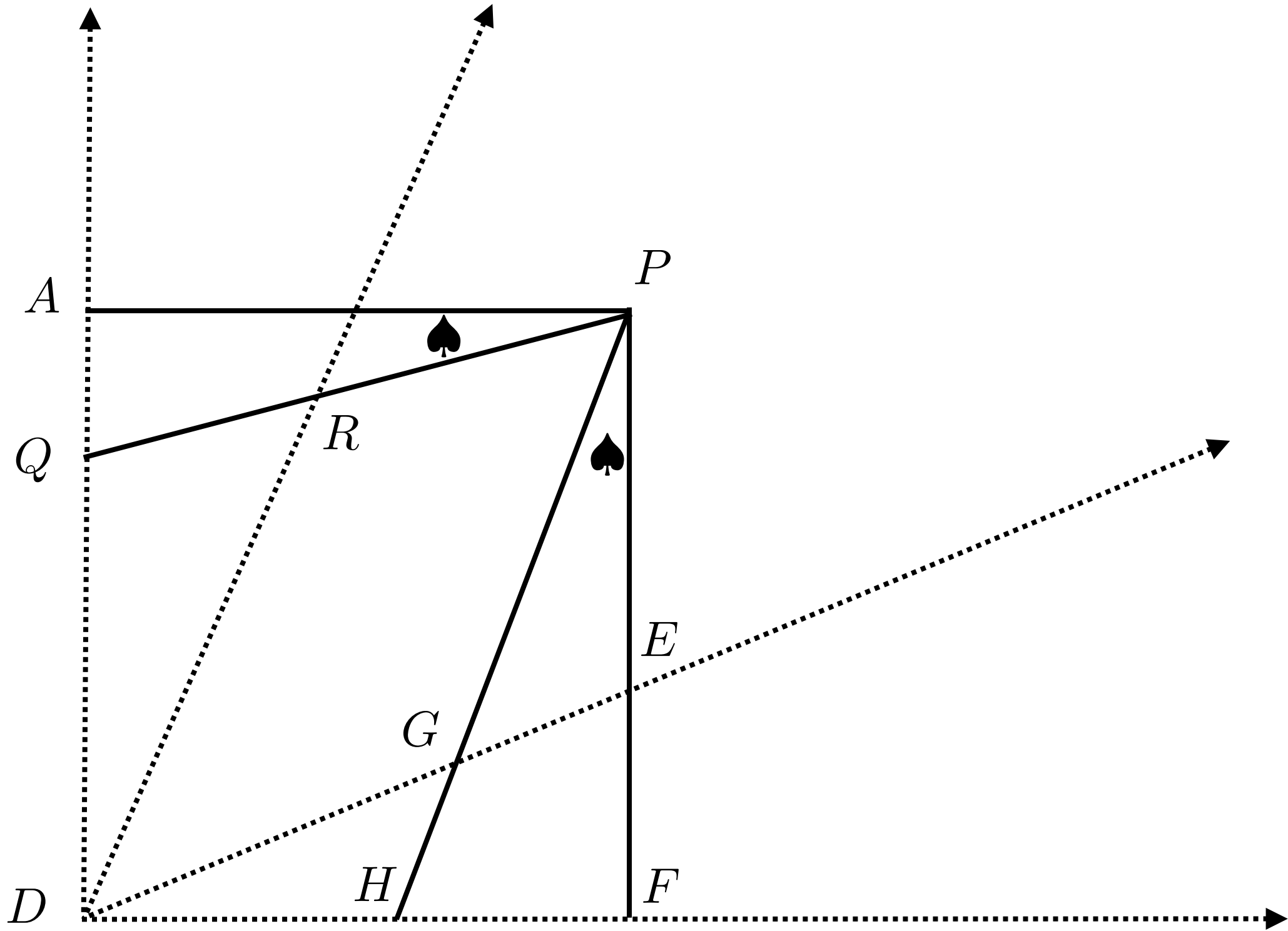



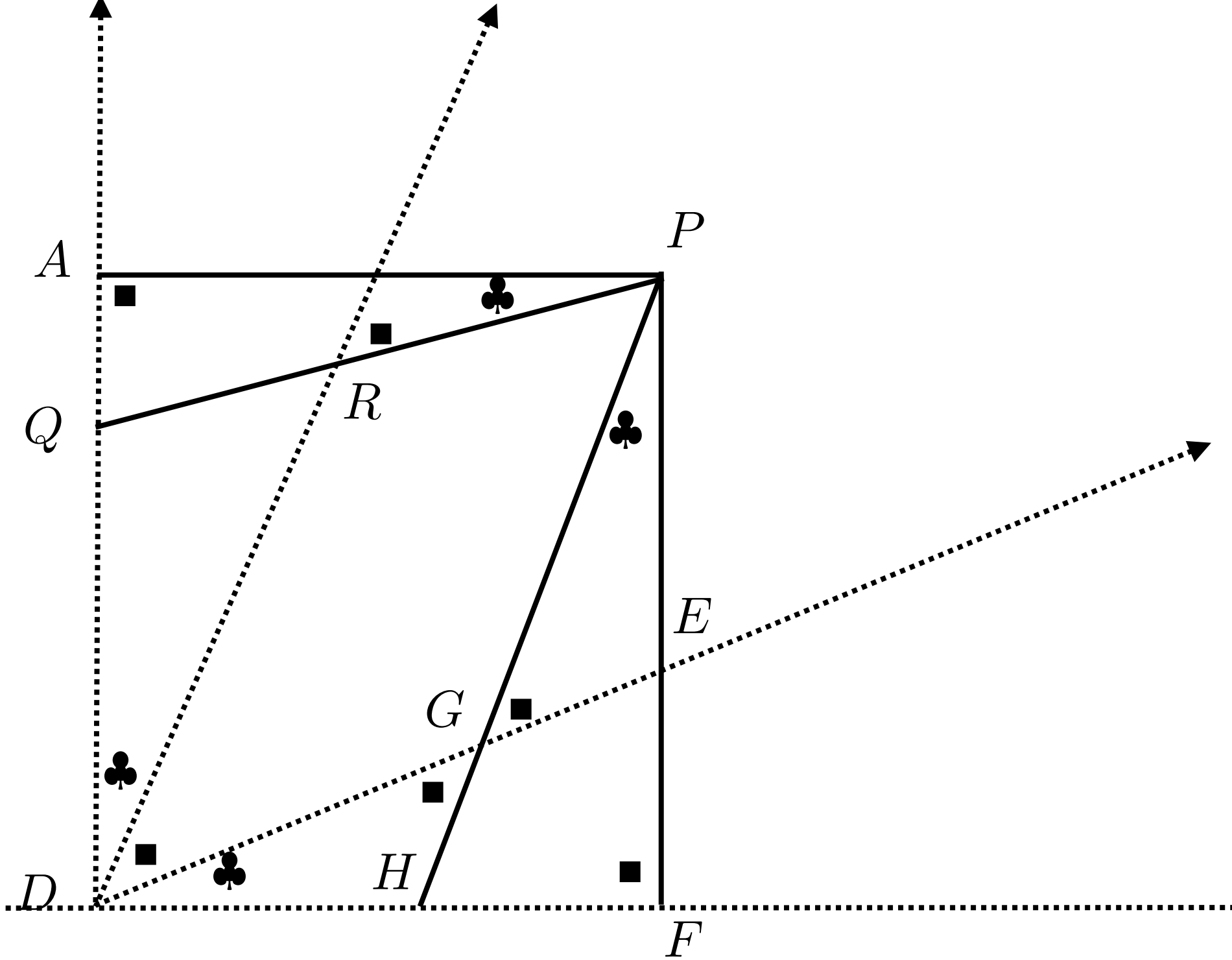

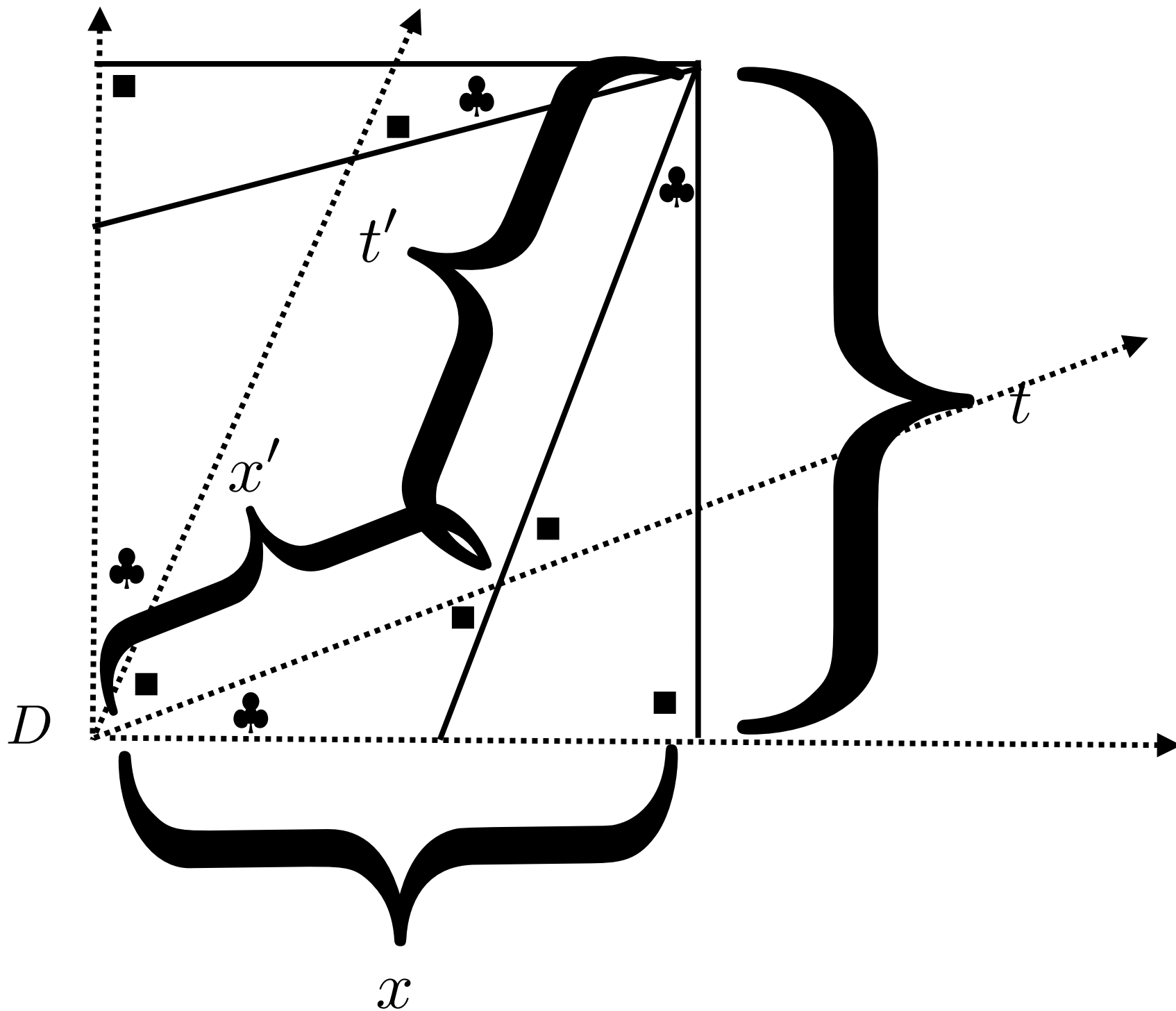

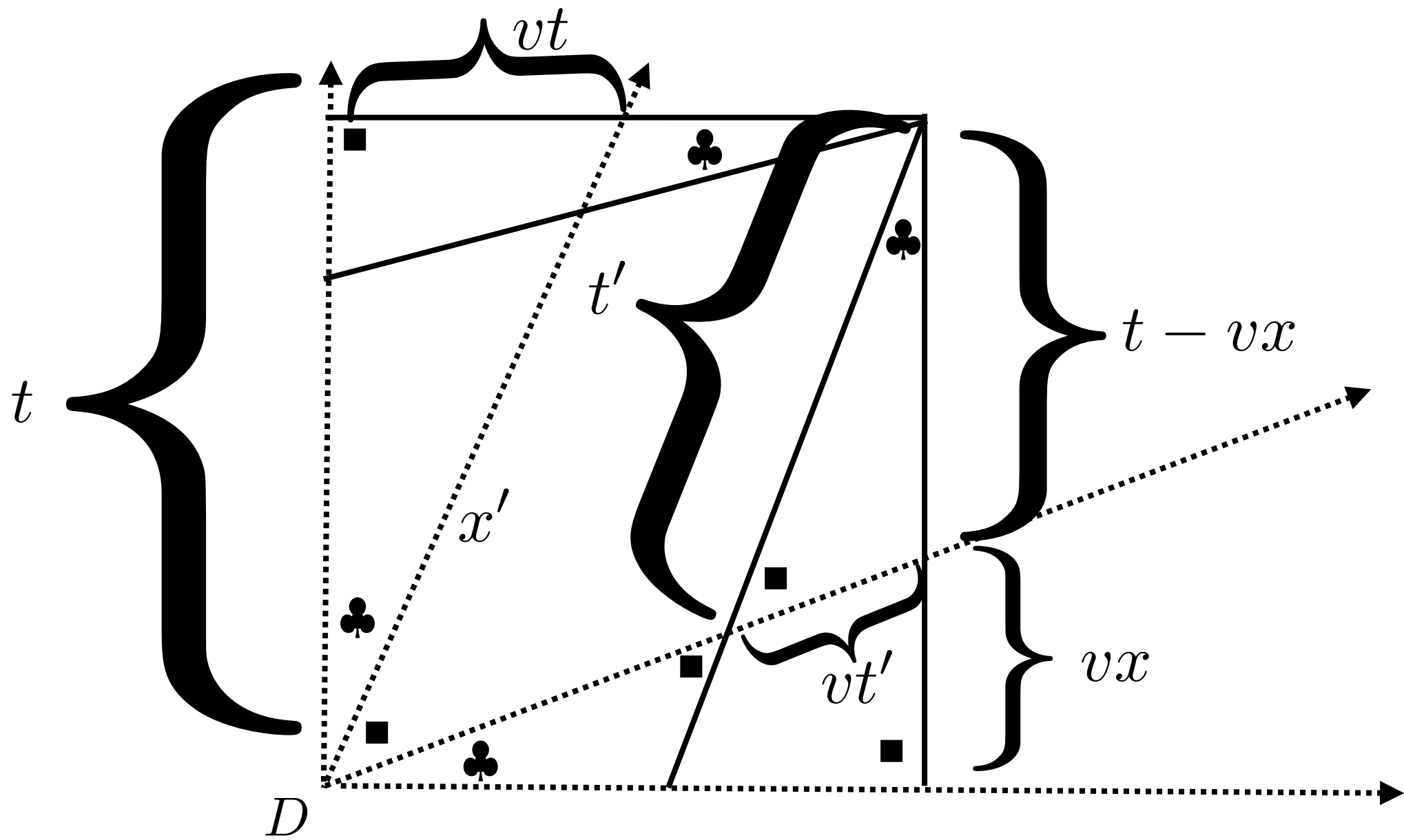

$$(t - vx)^2 = t'^2 - v^2 t'^2$$

$$t' = \frac{t - vx}{\sqrt{1 - v^2}}$$

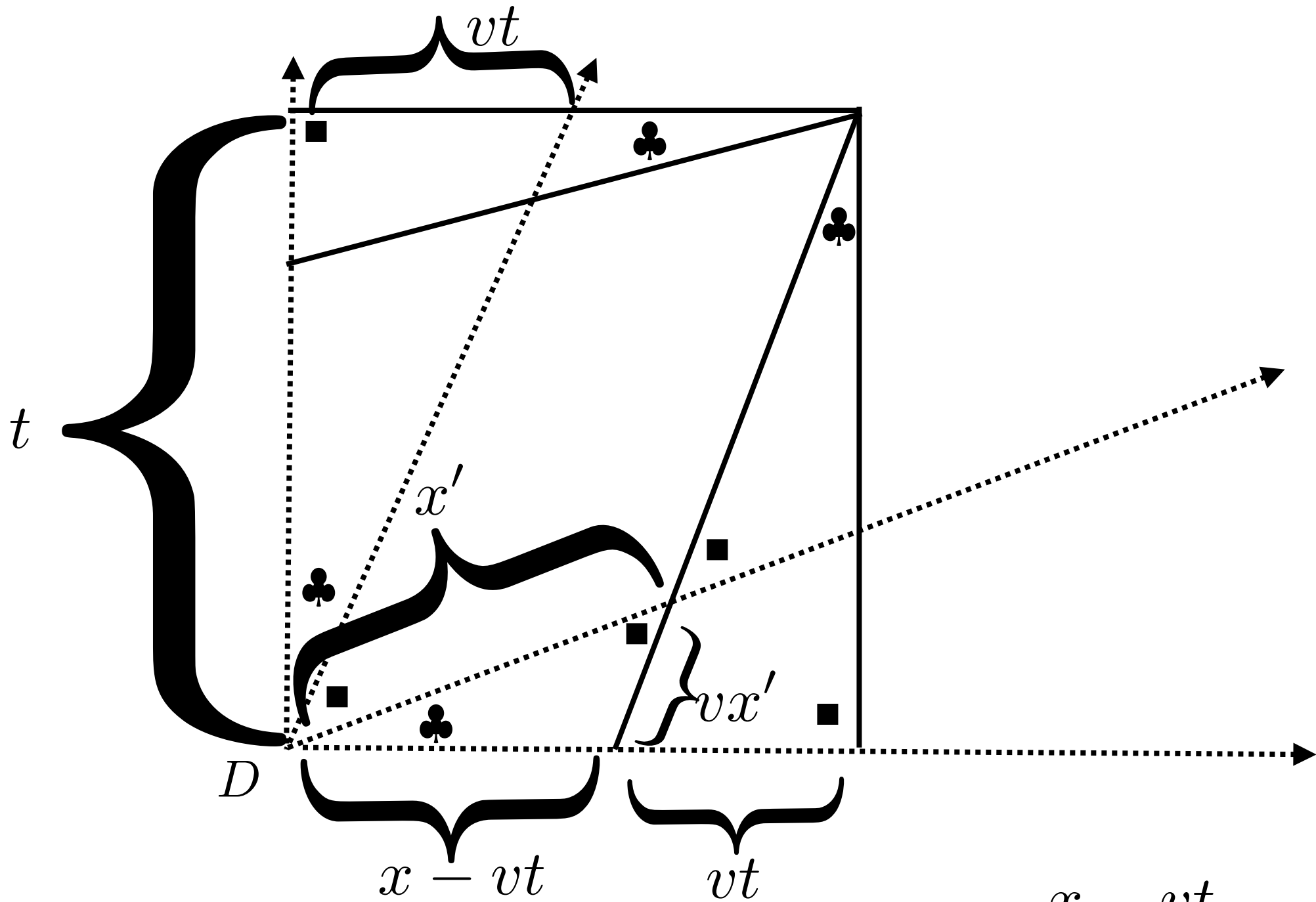

$$(x - vt)^2 = x'^2 - v^2 x'^2$$

$$x' = \frac{x - vt}{\sqrt{1 - v^2}}$$

