Recent photoproduction results obtained in a coupled-channel framework

Helmut Haberzettl

Institute for Nuclear Studies and Department of Physics

THE GEORGE WASHINGTON UNIVERSITY

WASHINGTON, DC

George
Washington →



Jülich–Athens–Washington Collaboration

Jülich:

M. Döring
J. Haidenbauer
Ch. Hanhart
S. Krewald
U.-G. Meißner
D. Rönchen

Forschungszentrum Jülich

Athens:

F. Huang
K. Nakayama

The University of Georgia

Washington:

H. Haberzettl

The George Washington University



Jülich–Athens–Washington Collaboration

Jülich:

M. Döring
J. Haidenbauer
Ch. Hanhart
S. Krewald
U.-G. Meißner
D. Rönchen

Forschungszentrum Jülich

Athens:

F. Huang
K. Nakayama

The University of Georgia

Washington:

H. Haberzettl

The George Washington University





The

JAW

Collaboration

Jülich–**A**thens/GA–**W**ashington/DC



**Recent photoproduction results
obtained in a coupled-channel framework**

Helmut Haberzettl

Institute for Nuclear Studies and Department of Physics

THE GEORGE WASHINGTON UNIVERSITY

WASHINGTON, DC



Recent photoproduction results
obtained in a coupled-channel framework

Helmut Haberzettl

Institute for Nuclear Studies and Department of Physics

THE GEORGE WASHINGTON UNIVERSITY

WASHINGTON, DC



Goal

- Provide a **microscopically consistent formulation** of meson photoproduction processes off the nucleon valid for real *and* virtual photons within the framework of a coupled-channel formalism
- Full implementation of **gauge invariance** (in terms of *off-shell* Generalized Ward-Takahashi identities)
- In practice, approximations will be necessary: Provide prescriptions to retain microscopic consistency and gauge invariance even then

Procedure

- Use field theory based on hadronic Lagrangians
- Employ LSZ-type mechanisms to couple electromagnetic field to fully dressed hadronic propagators and vertices



Overview

- Consistent implementation of gauge invariance
- Example: Pion photoproduction
- Summary
- η' Photoproduction
- Discussion

NB: Pions and nucleons here are placeholders for arbitrary mesons and baryons.
Note also, the formulation is valid for real *and* virtual photons.



Gauge Invariance

$(N + 1)$ -point current:

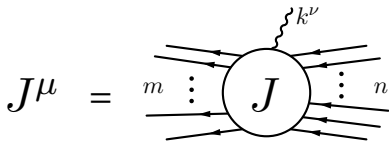

one incoming photon
 n incoming hadrons
 m outgoing hadrons
 $N = m + n$



Gauge Invariance

$(N + 1)$ -point current:

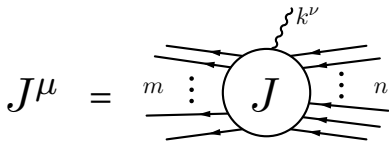

one incoming photon
 n incoming hadrons
 m outgoing hadrons
 $N = m + n$

Vanishing four-divergence:

$$\partial_\mu J^\mu = 0$$

alle external hadrons on-shell

Equivalent continuity equation:

$$\frac{\partial \rho}{\partial t} - \nabla \cdot \mathbf{J} = 0$$

$$J^\mu = (\rho, \mathbf{J})$$

Implies charge conservation:

$$Q = \int d^3r \rho = \text{const}$$



Where does it come from?



Gauge Invariance \equiv U(1) Invariance

Global gauge invariance: Physics invariant under global phase transformation of field

$$\phi \rightarrow \phi e^{-i\lambda}$$

λ : real, constant

implies a conserved charge



Gauge Invariance \equiv U(1) Invariance

Global gauge invariance: Physics invariant under global phase transformation of field

$$\phi \rightarrow \phi e^{-i\lambda}$$

λ : real, constant

implies a conserved charge

This is not very helpful from a dynamical point of view since charge conservation is built into the models explicitly anyway, either via the isospin formalism or by employing an explicit particle basis.



Gauge Invariance \equiv U(1) Invariance

Global gauge invariance: Physics invariant under global phase transformation of field

$$\phi \rightarrow \phi e^{-i\lambda} \quad \lambda: \text{real, constant}$$

implies a conserved charge

Local gauge invariance: Physics invariant under **local** phase transformation of field

$$\phi \rightarrow \phi e^{-i\Lambda(x)} \quad \Lambda: \text{real function of } x$$

implies a conserved charge



Gauge Invariance \equiv U(1) Invariance

Global gauge invariance: Physics invariant under global phase transformation of field

$$\phi \rightarrow \phi e^{-i\lambda} \quad \lambda: \text{real, constant}$$

implies a conserved charge

Local gauge invariance: Physics invariant under **local** phase transformation of field

$$\phi \rightarrow \phi e^{-i\Lambda(x)} \quad \Lambda: \text{real function of } x$$

implies a conserved charge

In addition, it implies the very existence of the electromagnetic field A^μ , i.e., it provides the Maxwell equations:

$$\partial_\nu F^{\mu\nu} = -J^\mu \quad F^{\mu\nu} = \partial^\mu A^\nu - \partial^\nu A^\mu$$



Gauge Invariance \equiv U(1) Invariance

Global gauge invariance: Physics invariant under global phase transformation of field

$$\phi \rightarrow \phi e^{-i\lambda} \quad \lambda: \text{real, constant}$$

implies a conserved charge

Local gauge invariance: Physics invariant under **local** phase transformation of field

$$\phi \rightarrow \phi e^{-i\Lambda(x)} \quad \Lambda: \text{real function of } x$$

implies a conserved charge

In addition, it implies the very existence of the electromagnetic field A^μ , i.e., it provides the Maxwell equations:

$$\partial_\nu F^{\mu\nu} = -J^\mu \quad F^{\mu\nu} = \partial^\mu A^\nu - \partial^\nu A^\mu$$

Violation of local gauge invariance tampers with consistent implementation of the electromagnetic field!



Gauge Invariance

Use the requirement of *local gauge invariance* as a tool for finding all reaction mechanisms that must be considered simultaneously



Current Conservation vs. Local Gauge Invariance

Current conservation:

$$k_\mu J^\mu = 0$$

Decompose current into transverse and longitudinal pieces:

$$J^\mu = J_T^\mu + J_L^\mu$$

Current conservation:

$$k_\mu J_T^\mu = 0 \text{ (trivial)}$$

and

$$k_\mu J_L^\mu = 0$$

(non-trivial)

Amplitude for real photons ($k^2 = 0$ and $k_\mu \varepsilon^\mu = 0$):

$$\varepsilon_\mu J^\mu = \varepsilon_\mu J_T^\mu$$

Real photons never see the non-trivial part of the current.



Current Conservation vs. Local Gauge Invariance

Current conservation:

$$\boxed{k_\mu J^\mu = 0}$$

on-shell condition

Decompose current into transverse and longitudinal pieces:

$$J^\mu = J_T^\mu + J_L^\mu$$

Current conservation:

$$k_\mu J_T^\mu = 0 \text{ (trivial)}$$

and

$$\boxed{k_\mu J_L^\mu = 0} \text{ (non-trivial)}$$

Amplitude for real photons ($k^2 = 0$ and $k_\mu \varepsilon^\mu = 0$):

$$\boxed{\varepsilon_\mu J^\mu = \varepsilon_\mu J_T^\mu}$$

Real photons never see the non-trivial part of the current.

■ Dynamically consistent framework:

Local gauge invariance appears as **off-shell conditions**

in the form of **generalized Ward-Takahashi identities** that

link longitudinal and transverse current contributions dynamically



Pion Photoproduction: $\gamma N \rightarrow \pi N$

Photoproduction current:

$$M^\mu = M_s^\mu + M_u^\mu + M_t^\mu + M_{\text{int}}^\mu$$

The diagram shows the decomposition of the photoproduction current M^μ into four terms:

- M_s^μ : s-channel exchange of a nucleon (N) between the photon and the target nucleon.
- M_u^μ : u-channel exchange of a nucleon (N) between the photon and the target nucleon.
- M_t^μ : t-channel exchange of a pion (π) between the photon and the target nucleon.
- M_{int}^μ : contact interaction between the photon, pion, and nucleon.



Pion Photoproduction: $\gamma N \rightarrow \pi N$

Photoproduction current:

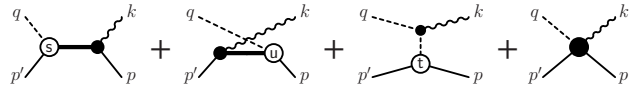
$$M^\mu = M_s^\mu + M_u^\mu + M_t^\mu + M_{\text{int}}^\mu$$

The diagram shows four Feynman diagrams representing the components of the photoproduction current M^μ . Each diagram has an incoming photon line (dashed) with momentum q and an outgoing pion line (wavy) with momentum k . The nucleon lines are solid, with incoming momentum p' and outgoing momentum p . The diagrams are:

- M_s^μ : A nucleon line with a vertex labeled 'S' (circled) where the photon and pion meet.
- M_u^μ : A nucleon line with a vertex labeled 'u' (circled) where the photon and pion meet.
- M_t^μ : A nucleon line with a vertex labeled 't' (circled) where the photon and pion meet.
- M_{int}^μ : A nucleon line with a vertex where the photon and pion meet.

NB: This is the **full topological structure of the current** — even in the most sophisticated implementation of the problem



Gauge Invariance: Generalized Ward-Takahashi identities

$$M^\mu = M_s^\mu + M_u^\mu + M_t^\mu + M_{\text{int}}^\mu$$

Generalized WTI for the full current M^μ :

$$k_\mu M^\mu = 0 \text{ on-shell}$$

$$k_\mu M^\mu = \underbrace{-F_s S(p+k) Q_i S^{-1}(p)}_{s\text{-channel}} + \underbrace{S^{-1}(p') Q_f S(p'-k) F_u}_{u\text{-channel}} + \underbrace{\Delta_\pi^{-1}(q) Q_\pi \Delta_\pi(q-k) F_t}_{t\text{-channel}}$$

WTI for the nucleon current Γ^μ :

$$k_\mu \Gamma^\mu = S^{-1}(p+k) Q_N + Q_N S^{-1}(p)$$

Generalized WTI for the interaction current M_{int}^μ :

$$k_\mu M_{\text{int}}^\mu = -F_s Q_i + Q_f F_u + Q_\pi F_t$$



■ Pion-production current M^μ :

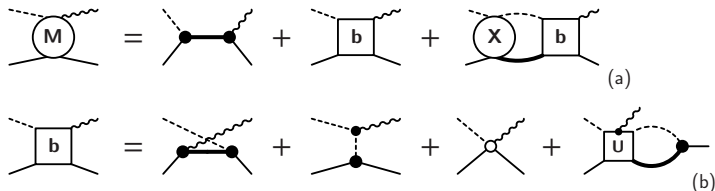

■ Nucleon current Γ^μ :

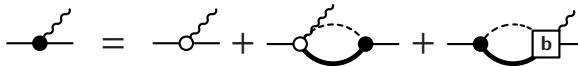

⇒ The internal structures of the dressed nucleon current can be understood by the dynamics of the pion production current.

■ Tower of *nonlinear* Dyson-Schwinger-type equations



πN T -matrix

pole non-pole

(a)

(b)

(d)

(c)

(e)

dressed nucleon propagator

(a)

dressed πNN vertex

(b)

propagator
determines
current

■ Tower of *nonlinear* Dyson-Schwinger-type equations



πN T -matrix

$$T = \overbrace{\text{pole}} + \overbrace{\text{non-pole}} + X \quad (a)$$

$$T = V + \text{diagram} + X = \text{diagram} + U + X \quad (d)$$

$$V = \text{diagram} + U \quad (c)$$

$$U = \text{diagram} + \dots \quad (e)$$

dressed nucleon propagator

$$\text{dressed nucleon propagator} = \text{bare nucleon propagator} + \text{self-energy loop} \quad (a)$$

dressed πNN vertex

$$\text{dressed } \pi NN \text{ vertex} = \text{bare } \pi NN \text{ vertex} + \text{diagram with X} \quad (b)$$

propagator determines current

Tower of *nonlinear* Dyson-Schwinger-type equations



Hadronic Input: The Jülich Model

(the latest incarnation)

Coupled system of equations with Lippmann-Schwinger structure:

$$T = V + VG_0T$$

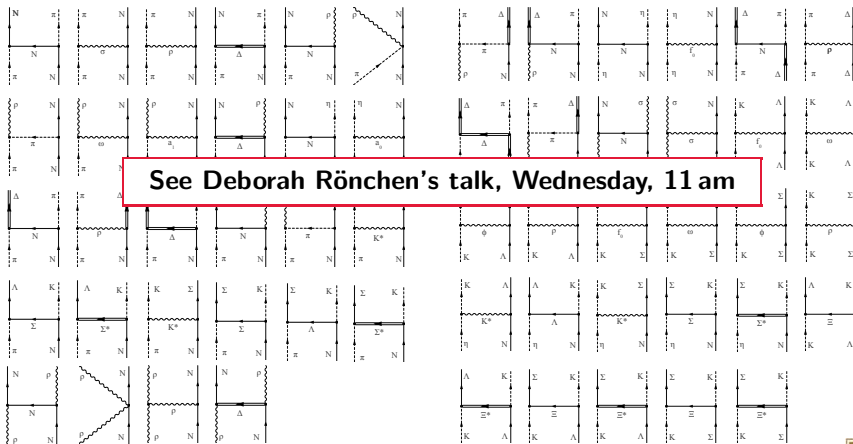

D. Rönchen, M. Döring, F. Huang, H. Haberzettl, J. Haidenbauer, C. Hanhart, S. Krewald, U.-G. Meißner, K. Nakayama, EPJA49:44(2013)



Hadronic Input: The Jülich Model

(the latest incarnation)

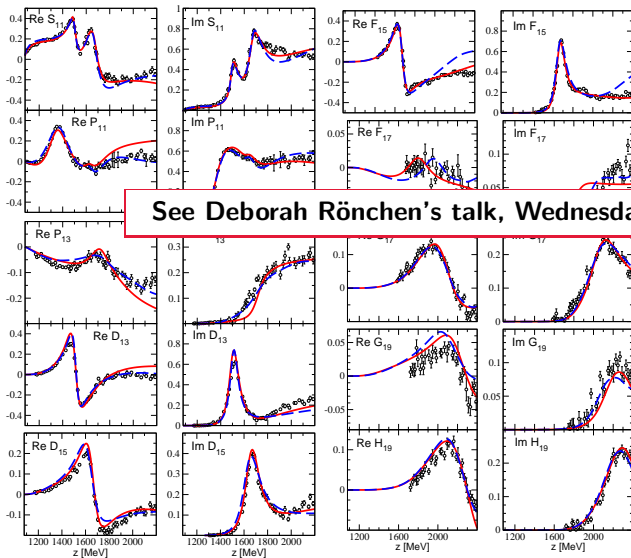

See Deborah Rönchen's talk, Wednesday, 11 am

$\pi N \rightarrow \pi N$
Isospin 1/2

Reaction $\pi N \rightarrow \pi N$, S - to D -wave.

Reaction $\pi N \rightarrow \pi N$, F - to H -wave.



Hadronic Input: The Jülich Model

(the latest incarnation)

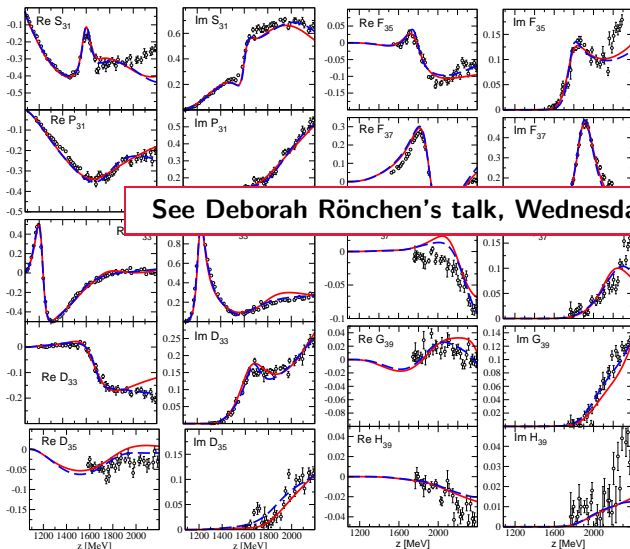

See Deborah Rönchen's talk, Wednesday, 11 am

$\pi N \rightarrow \pi N$
Isospin 3/2

Reaction $\pi N \rightarrow \pi N$, S- to D-wave.

Reaction $\pi N \rightarrow \pi N$, F- to H-wave.



■ Pion-production current M^μ :

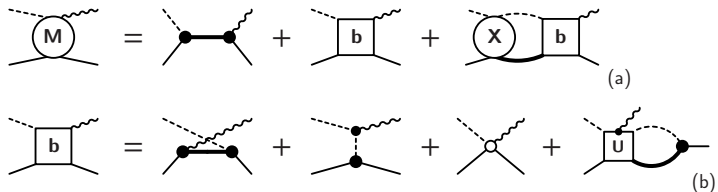

■ Nucleon current Γ^μ :

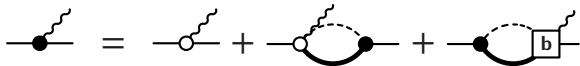

⇒ The internal structures of the dressed nucleon current can be understood by the dynamics of the pion production current.

■ Tower of *nonlinear* Dyson-Schwinger-type equations



■ Pion-production current M^μ :

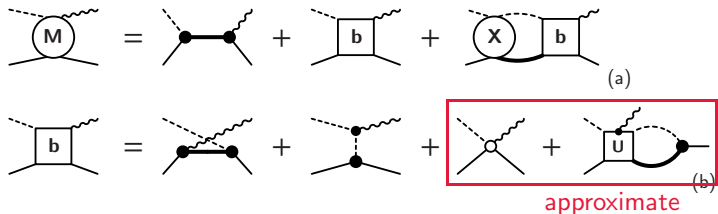

■ Nucleon current Γ^μ :



⇒ The internal structures of the dressed nucleon current can be understood by the dynamics of the pion production current.

■ Tower of *nonlinear* Dyson-Schwinger-type equations



■ Pion-production current M^μ :

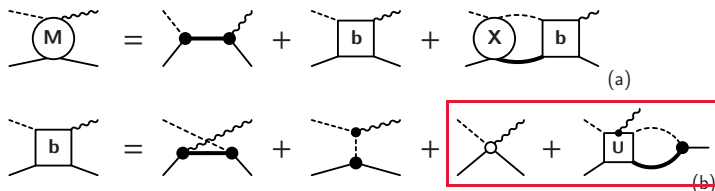

■ Lowest-order approximation in terms of phenomenological form factors:

$$\begin{aligned}
 M_c^\mu = & g e \gamma_5 \frac{i \sigma^{\mu\nu} k_\nu}{4m^2} \tilde{\kappa}_N - (1 - \lambda) g \frac{\gamma_5 \gamma^\mu}{2m} \tilde{F}_t e_\pi - G_\lambda \left[e_i (2p + k)^\mu \frac{\tilde{F}_s - \hat{F}}{s - p^2} \right. \\
 & \left. + e_f (2p' - k)^\mu \frac{\tilde{F}_u - \hat{F}}{u - p'^2} + e_\pi (2q - k)^\mu \frac{\tilde{F}_t - \hat{F}}{t - q^2} e \right]
 \end{aligned}$$

Phenomenological contact current
— no poles

Approximation preserves the full off-shell generalized WTI



Does it work? — Yes!

Results for $\gamma N \rightarrow \pi N$

See also Deborah Rönchen's talk, Wednesday, 11 am

$$\frac{d\sigma}{d\Omega}$$

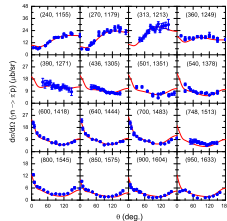
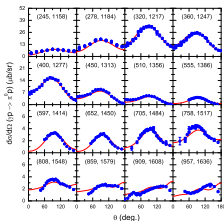
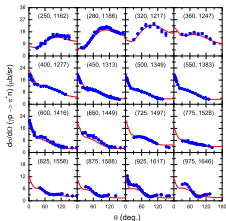

$$\Sigma$$

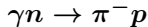
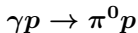
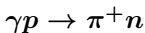
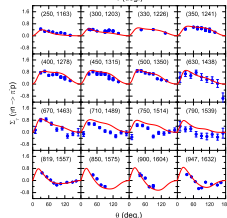
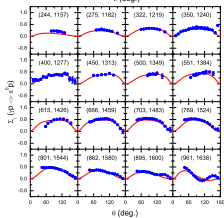
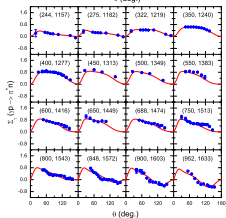

F. Huang, M. Döring, H. Haberzettl, J. Haidenbauer, C. Hanhart, S. Krewald, U.-G. Meißner, and K. Nakayama, PRC85, 054003 (2012)



Why?

Q: Why is it so important to maintain gauge invariance in terms of off-shell conditions?

A: Because current contributions for off-shell particles occur naturally in complex dynamical situations. **Example:** Two-pion production



Attach Photon — No-loop Graphs

The diagram shows an equation between three Feynman diagrams. On the left is a vertex labeled 'NL' (Non-Linear) represented by a black oval with two dashed lines entering from the top. This is equal to the sum of two diagrams on the right. The first diagram on the right shows two vertices connected by a solid line, with two dashed lines entering from the top. The second diagram on the right shows a vertex connected to a wavy line (representing a photon) which then connects to another vertex, with two dashed lines entering from the top.



Attach Photon — No-loop Graphs



Example for attaching photon:

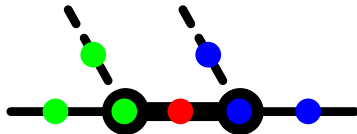

Attach Photon — No-loop Graphs



Example for attaching photon:

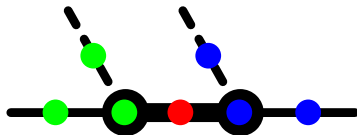

$$M = 3 \times \text{green} + \text{red} \quad \text{red} + 3 \times \text{blue} = M$$



Attach Photon — No-loop Graphs



↓ attach photon

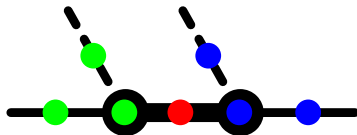

$$M = 3 \times \text{green} + \text{red} \quad \text{red} + 3 \times \text{blue} = M$$

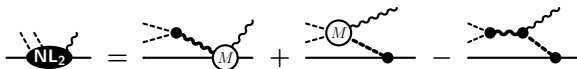
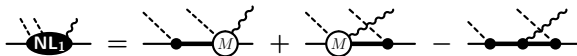

Attach Photon — No-loop Graphs

$$\text{NL} = \text{NL}_1 + \text{NL}_2$$

attach photon

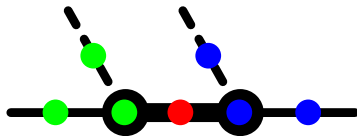

$$M = 3 \times \text{green} + \text{red} \quad \text{red} + 3 \times \text{blue} = M$$

$$\text{NL} = \text{NL}_1 + \text{NL}_2$$

$$\text{NL}_1 = \text{NL}_1^+ + \text{NL}_1^- - \text{NL}_1^{\text{double}}$$

$$\text{NL}_2 = \text{NL}_2^+ + \text{NL}_2^- - \text{NL}_2^{\text{double}}$$

Subtraction necessary to avoid double-counting of ●



Attach Photon — No-loop Graphs



attach photon

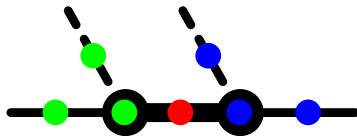

$$M = 3 \times \text{green} + \text{red} \quad \text{red} + 3 \times \text{blue} = M$$

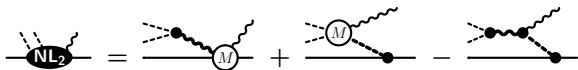
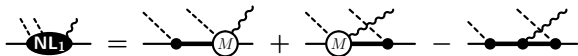

separately gauge invariant!

Local gauge invariance follows as a matter of course since all ingredients satisfy their respective off-shell WTIs 😊



Summary

- ✓ Full implementation of *local gauge invariance* order by order in terms of *Generalized Ward–Takahashi Identities* at all levels of the reaction dynamics.
⇒ Essential for the microscopic consistency of all reaction mechanisms.
- ✓ Valid for hadronic two- and three-point functions dressed by arbitrary internal mechanisms — even nonlinear ones.
- ✓ Extension to the production of two or more mesons straightforward.



η' Production

Combined analysis of

- $\gamma p \rightarrow \eta' p$
- quasifree $\gamma p \rightarrow \eta' p$ and $\gamma n \rightarrow \eta' n$
- $NN \rightarrow \eta' NN$
- $\pi N \rightarrow \eta' N$



Why η' production reactions?

- Aim: to extract N^* information in the less explored high N^* mass region
- Advantages of η' production reactions for N^* study

- Suitable for study of high mass resonances in low partial-wave states

$$M_{\eta'N}^{\text{threshold}} \approx 1897 \text{ MeV} \quad \gg \quad M_{\pi N}^{\text{threshold}} \approx 1077 \text{ MeV}$$

- $\eta'N$ has pure isospin $I = 1/2$, unlike πN which has isospin $I = 1/2, 3/2$
 \implies Suitable to concentrate on resonances with isospin $1/2$
- To study resonances coupled weakly to πN but relatively strongly to $\eta'N$
- Disadvantage of η' production reactions for N^* study: low production rate
 \implies Theoretical studies need to combine various reactions involving η'



What kind of data do we have?

- $\gamma p \rightarrow \eta' p$
 - $d\sigma/d\Omega$: CLAS-2009 [Phys. Rev. C **80**, 045213 (2009)]
 - $d\sigma/d\Omega$: CBELSA/TAPS-2009 [Phys. Rev. C **80**, 055202 (2009)]
- Quasi-free $\gamma p \rightarrow \eta' p$ & $\gamma n \rightarrow \eta' n$
 - $d\sigma/d\Omega$: CBELSA/TAPS-2011 [Eur. Phys. J. A **47**, 11 (2011)]
- $pp \rightarrow \eta' pp$
 - σ : COSY-1998 [Phys. Rev. Lett. **80**, 3202 (1998)]
 - σ : SPESIII-1998 [Phys. Lett. B **438**, 41 (1998)]
 - σ : COSY-2000 [Phys. Lett. B **474**, 416 (2000)]
 - σ & $d\sigma/d\Omega$: DISTO-2000 [Phys. Lett. B **491**, 29 (2000)]
 - σ & $d\sigma/d\Omega$: COSY-2004 [Eur. Phys. J. A **20**, 345 (2004)]
 - $d\sigma/dS_{pp}$ & $d\sigma/dS_{p\eta'}$: COSY-2010 [Phys. Lett. B **684**, 11 (2010)]
- $pn \rightarrow \eta' pn$
 - Upper limit of σ : COSY-2010 [Phys. Rev. C **81**, 035209 (2010)]
- $\pi N \rightarrow \eta' N$
 - σ : few data from 1970's



Model

Huang, HH, Nakayama, PRC 87, 054004 (2013)

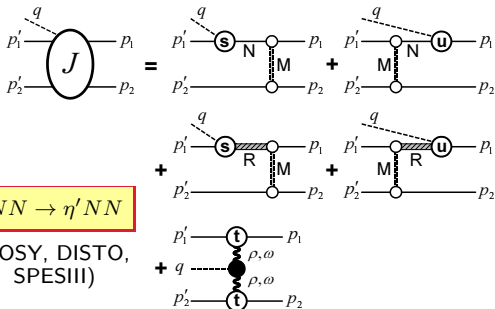
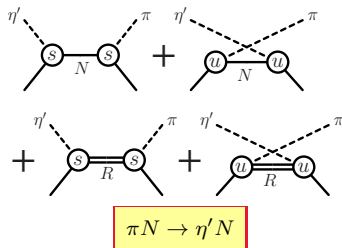
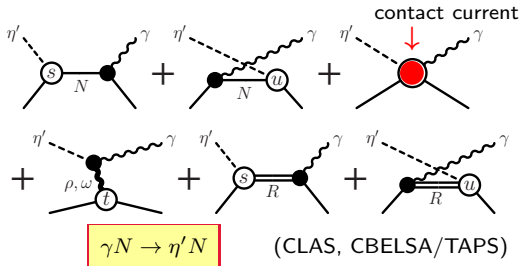

The NN ISI/FSI is treated in DWBA:
 $(1 + TG_0)J(G_0T + 1)$



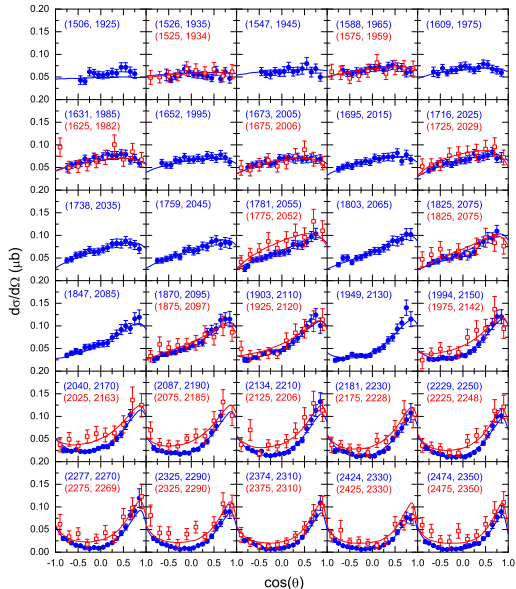

— CLAS 2009
 — CBELSA/TAPS 2009

Four resonances:
 $P_{13}(1720)$ ****, $S_{11}(1925)$ **,
 $P_{13}(2050)$ *, $P_{11}(2100)$ *

Discrepancy between
 CBELSA/TAPS
 and CLAS data



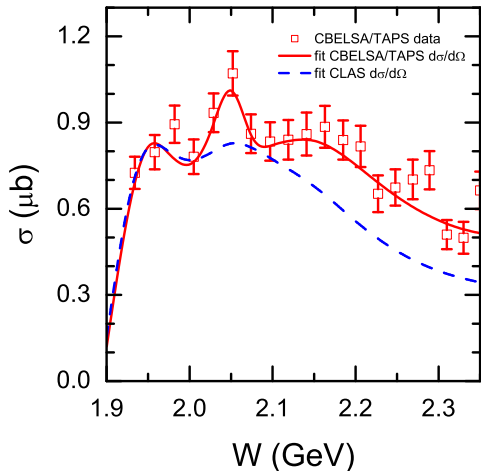

— CLAS 2009
— CBELSA/TAPS 2009

Four resonances:

$P_{13}(1720)$ ****, $S_{11}(1925)$ **,
 $P_{13}(2050)$ *, $P_{11}(2100)$ *

Discrepancy between
CBELSA/TAPS
and CLAS data

Will affect extraction
of resonances



Will skip discussion of other reactions for lack of time.

- The combined analysis of all reactions — free $\gamma p \rightarrow \eta' p$, quasifree $\gamma p \rightarrow \eta' p$ and $\gamma n \rightarrow \eta' n$, $\pi N \rightarrow \eta' N$, and $NN \rightarrow \eta' NN$ — was crucial to remove ambiguities in the resonance determination. This cannot be done by photodata alone. The only acceptable set found was $P_{13}(1720)$ ****, $S_{11}(1925)$ ** , $P_{13}(2050)$ * , $P_{11}(2100)$ *.
- Full coupled-channel calculation is feasible in principle. However, lack of hadronic data will introduce considerable uncertainty into the calculations: Only ~ 3800 hadronic data points vs. ~ 24600 photodata points; many hadronic data have large error bars and are inconsistent with each other. This is one of the major limitations for developing more accurate coupled-channel models.



Will skip discussion of other reactions for lack of time.

- The combined analysis of all reactions — free $\gamma p \rightarrow \eta' p$, quasifree $\gamma p \rightarrow \eta' p$ and $\gamma n \rightarrow \eta' n$, $\pi N \rightarrow \eta' N$, and $NN \rightarrow \eta' NN$ — was crucial to remove ambiguities in the resonance determination. This cannot be done by photodata alone. The only acceptable set found was $P_{13}(1720)$ ****, $S_{11}(1925)$ ** , $P_{13}(2050)$ * , $P_{11}(2100)$ *.
- Full coupled-channel calculation is feasible in principle. However, lack of hadronic data will introduce considerable uncertainty into the calculations: Only ~ 3800 hadronic data points vs. ~ 24600 photodata points; many hadronic data have large error bars and are inconsistent with each other. This is one of the major limitations for developing more accurate coupled-channel models.

Thank you!

