

Exclusive Electroexcitation of Baryon Resonances: Results and Outlook

Ralf W. Gothe

UNIVERSITY OF
SOUTH CAROLINA

PWA7 2013

7th International Workshop on Pion-Nucleon Partial-Wave Analysis and
the Interpretation of Baryon Resonances
September 23-27, 2013, Camogli, Italy

- **$\gamma_{\nu} NN^*$ Experiments:** The Best Access to the Baryon and Quark Structure?
 - Elastic Form Factors and **Transition Form Factors**
- **Analysis:** Phenomenological Extraction ... who can do better?
 - Consistent extraction of $\gamma_{\nu} NN^*$ electrocouplings in various decay channel with various models
- **QCD based Theory:** Solve Non-Perturbative **QCD** and Confinement?
- **Outlook:** Extended kinematics, new experiments ... what can be done next?

N* Spectrum in LQCD

The strong interaction physics is encoded in the nucleon excitation spectrum that spans the degrees of freedom from meson-baryon and dressed quarks to elementary quarks and gluons

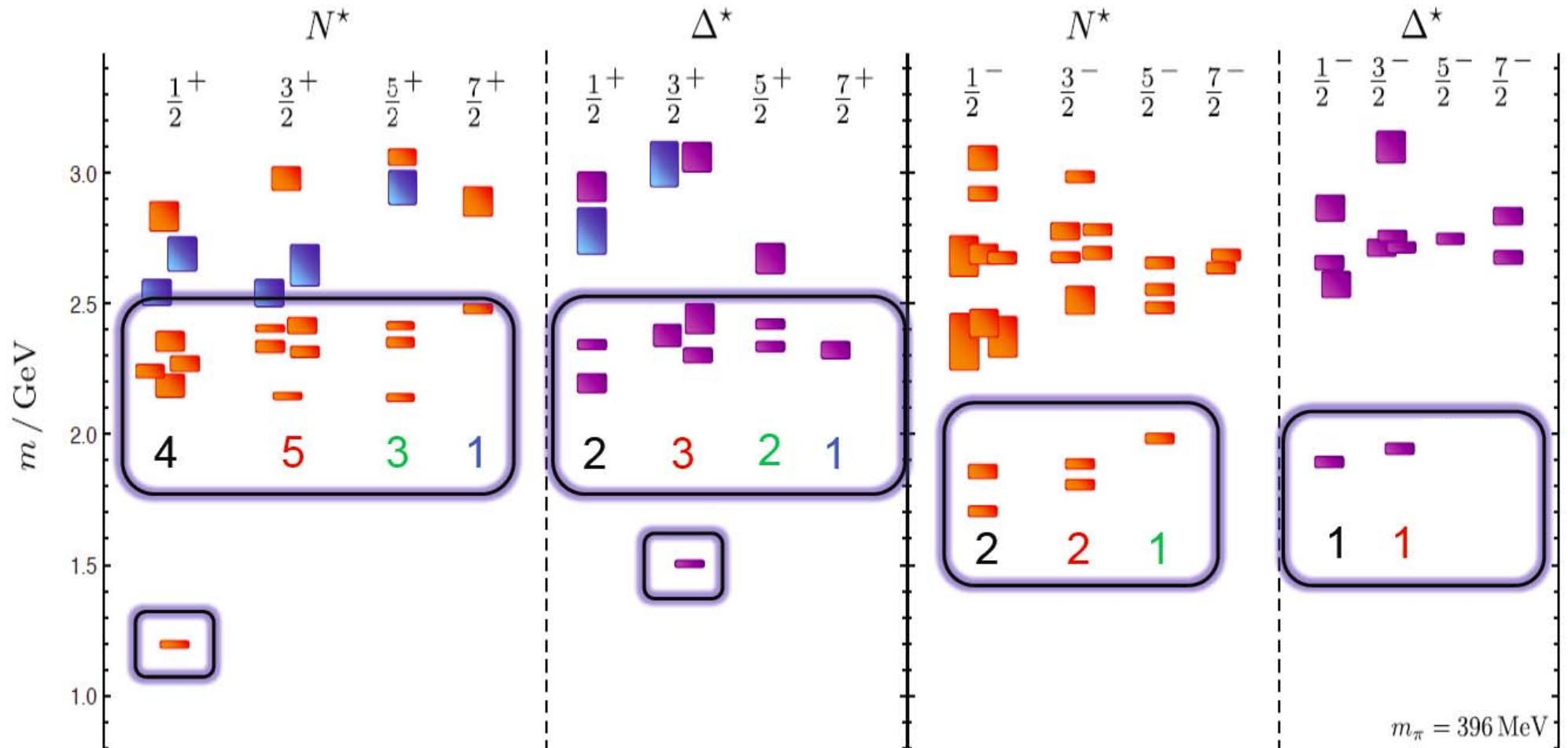

LQCD predicts states with the same quantum numbers as CQMs with underlying $SU(6) \times O(3)$ symmetry

R. Edwards et al.
arXiv:1104.5152, 1201.2349

N* Spectrum in LQCD

The strong interaction physics is encoded in the nucleon excitation spectrum that spans the degrees of freedom from meson-baryon and dressed quarks to elementary quarks and gluons

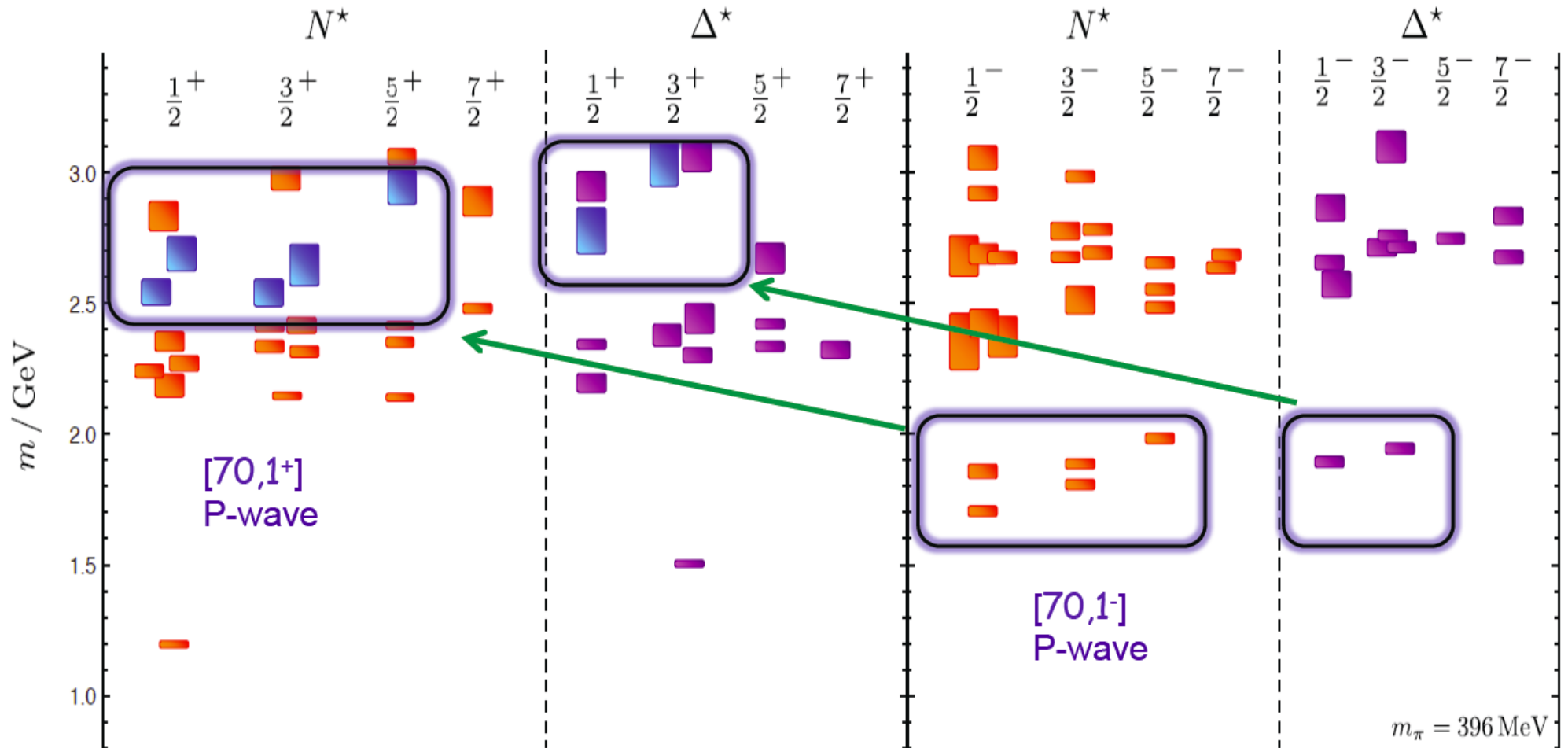

LQCD predicts hybrid baryon states replicating the negative parity multiplet structure

R. Edwards et al.
arXiv:1104.5152, 1201.2349

Baryon Spectrum in a RCQM

Relativistic covariant Constituent Quark Model (RCQM) based on the three-particle Bethe-Salpeter equation with flavor-dependent instanton-induced interaction

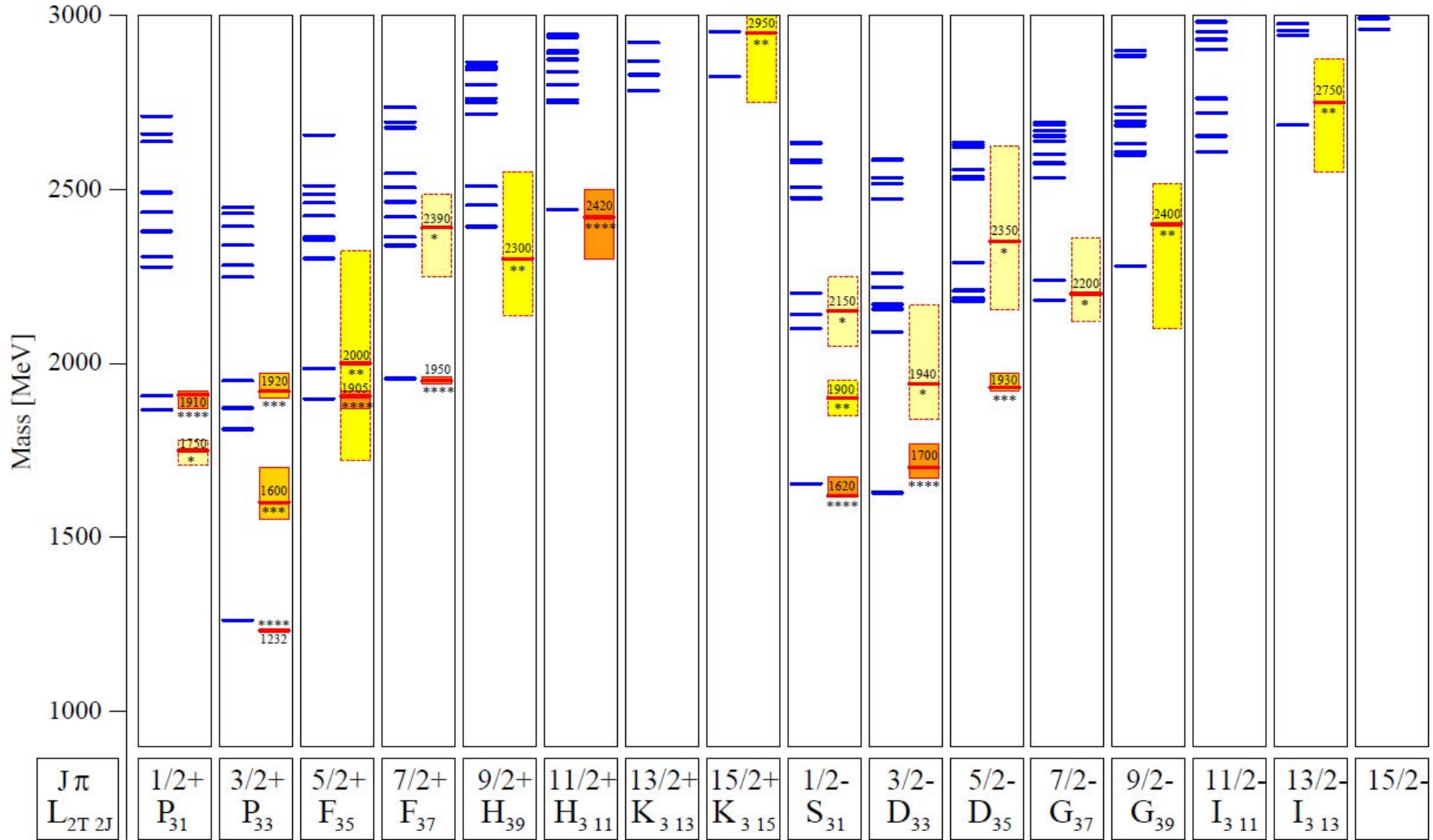

LQCD predicts states with the same quantum numbers as the CQM with underlying $SU(6) \times O(3)$ symmetry

B. Metsch and U. Löring, PiN Newsletter 16 (2002) 225-231

Baryon Spectrum in a RCQM

Relativistic covariant Constituent Quark Model (RCQM) based on the three-particle Bethe-Salpeter equation with flavor-dependent instanton-induced interaction

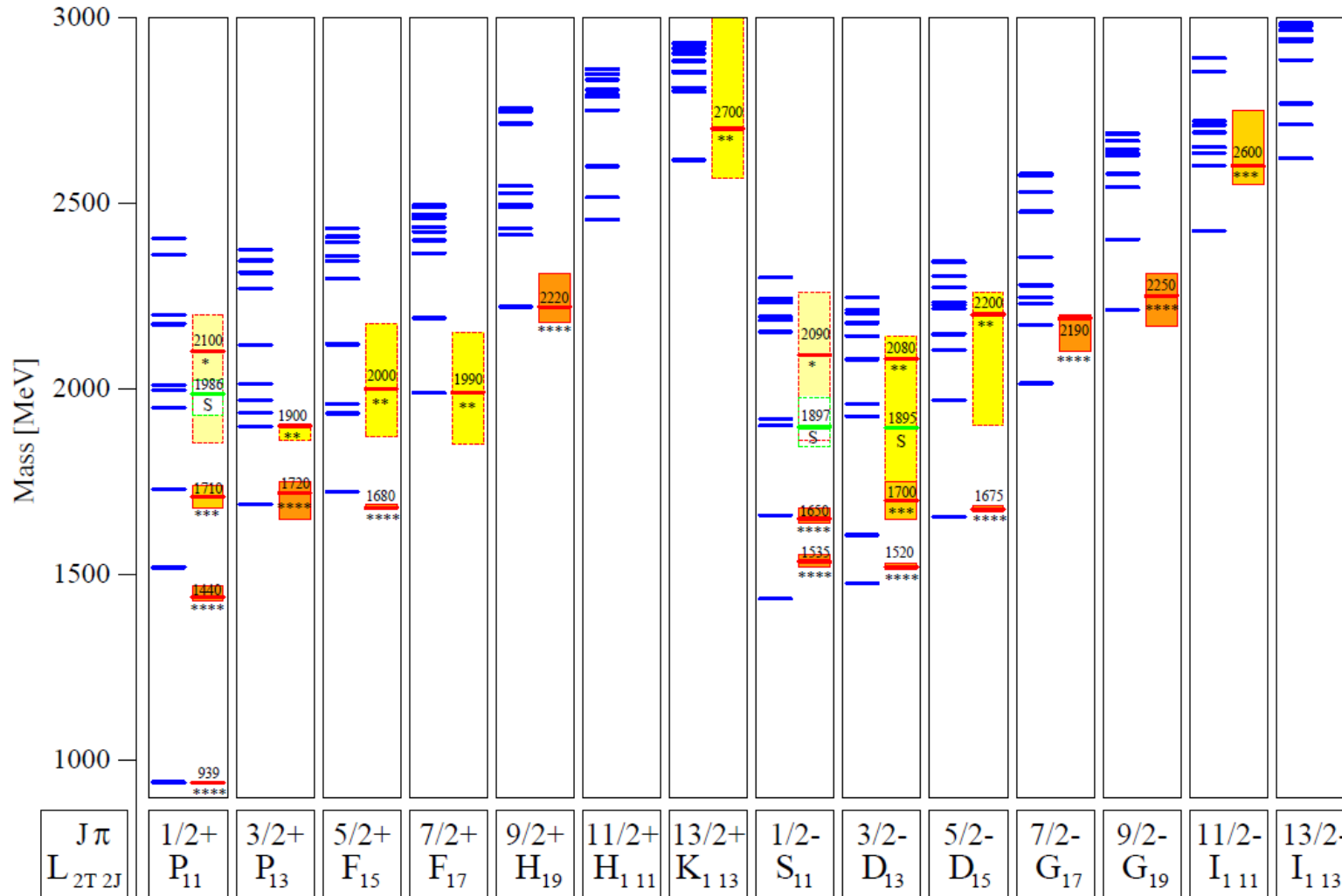

N*

LQCD predicts states with the same quantum numbers as the CQM with underlying $SU(6) \times O(3)$ symmetry

B. Metsch and U. Löring,
PiN Newsletter 16 (2002) 225-231

Hadron Structure with Electromagnetic Probes

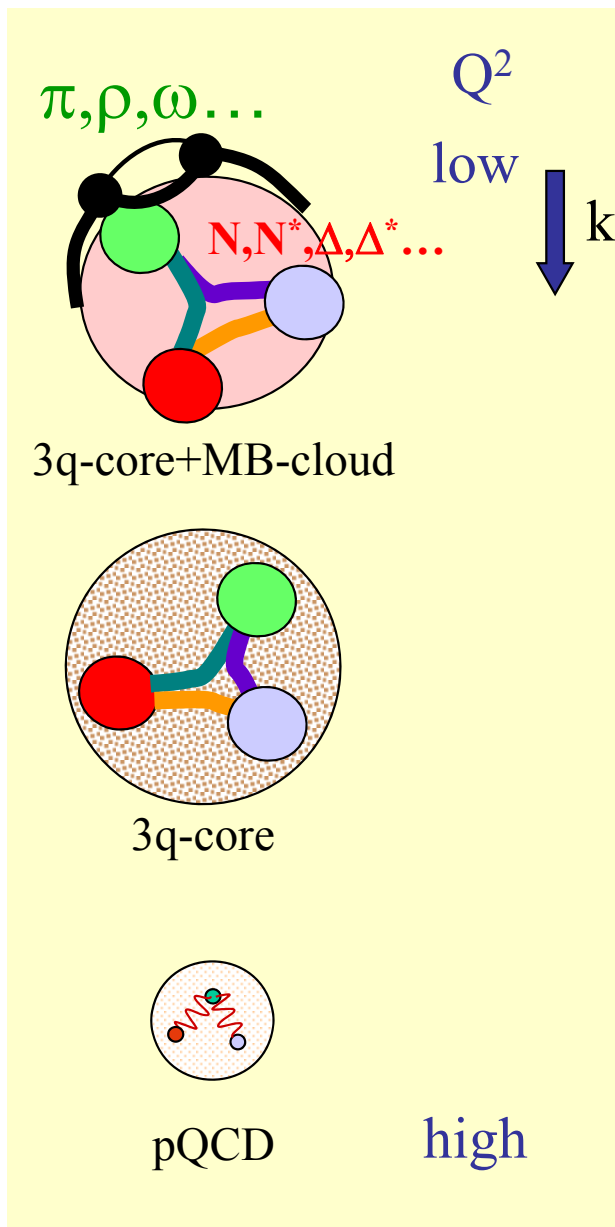

- Study the structure of the nucleon spectrum in the domain where dressed quarks are the major active degree of freedom.
- Explore the formation of excited nucleon states in interactions of dressed quarks and their emergence from QCD.

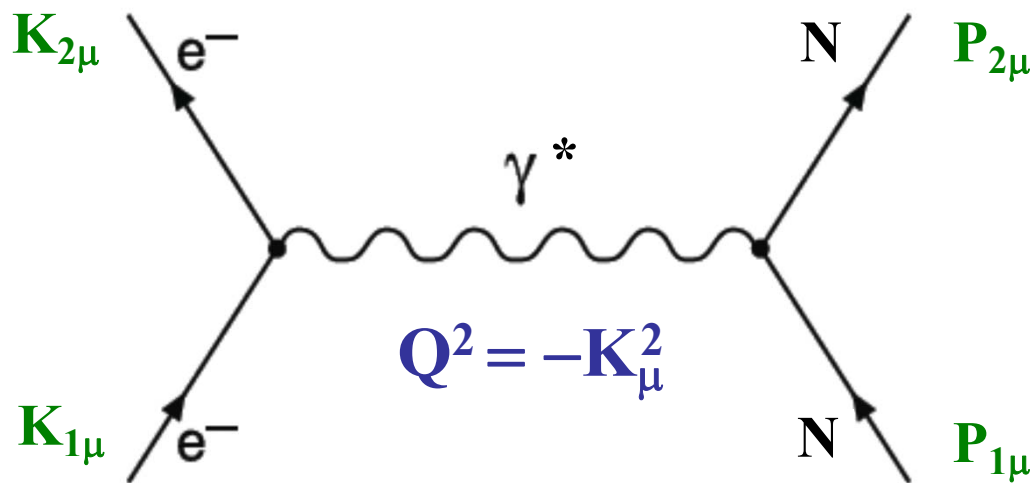

Hard Scattering off Bound and Confined Quarks

Baryon Excitations and Quasi-Elastic Scattering

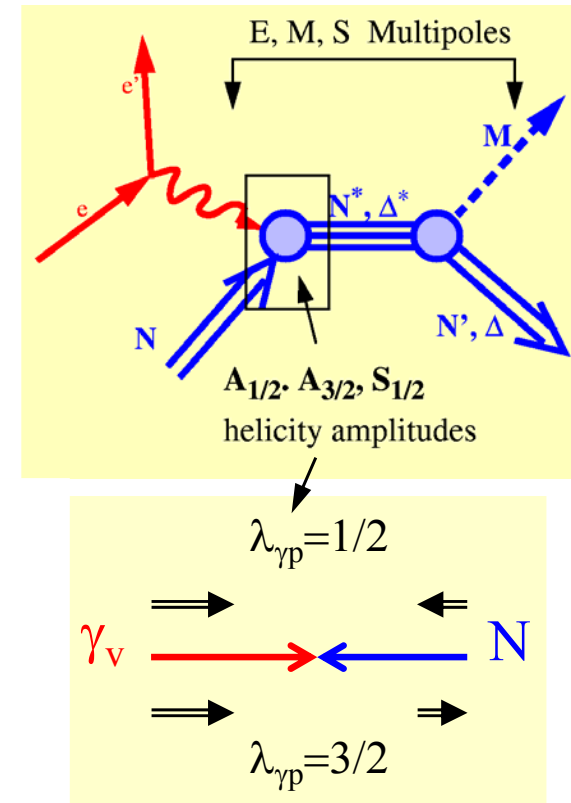
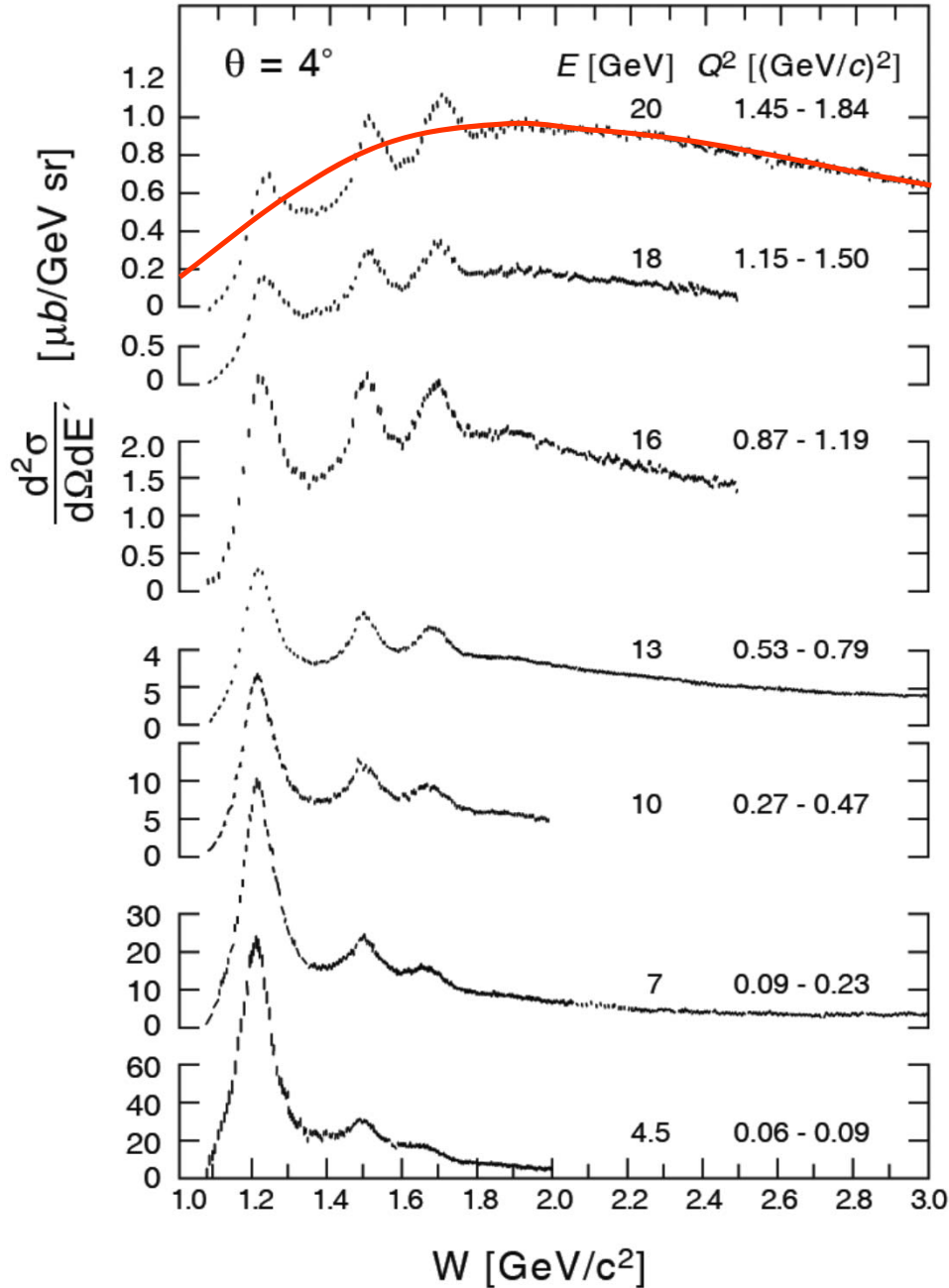

Deep Inelastic Scattering
 S. Stein et al., PR **D22** (1975) 1884

Baryon Excitations and Quasi-Elastic Scattering

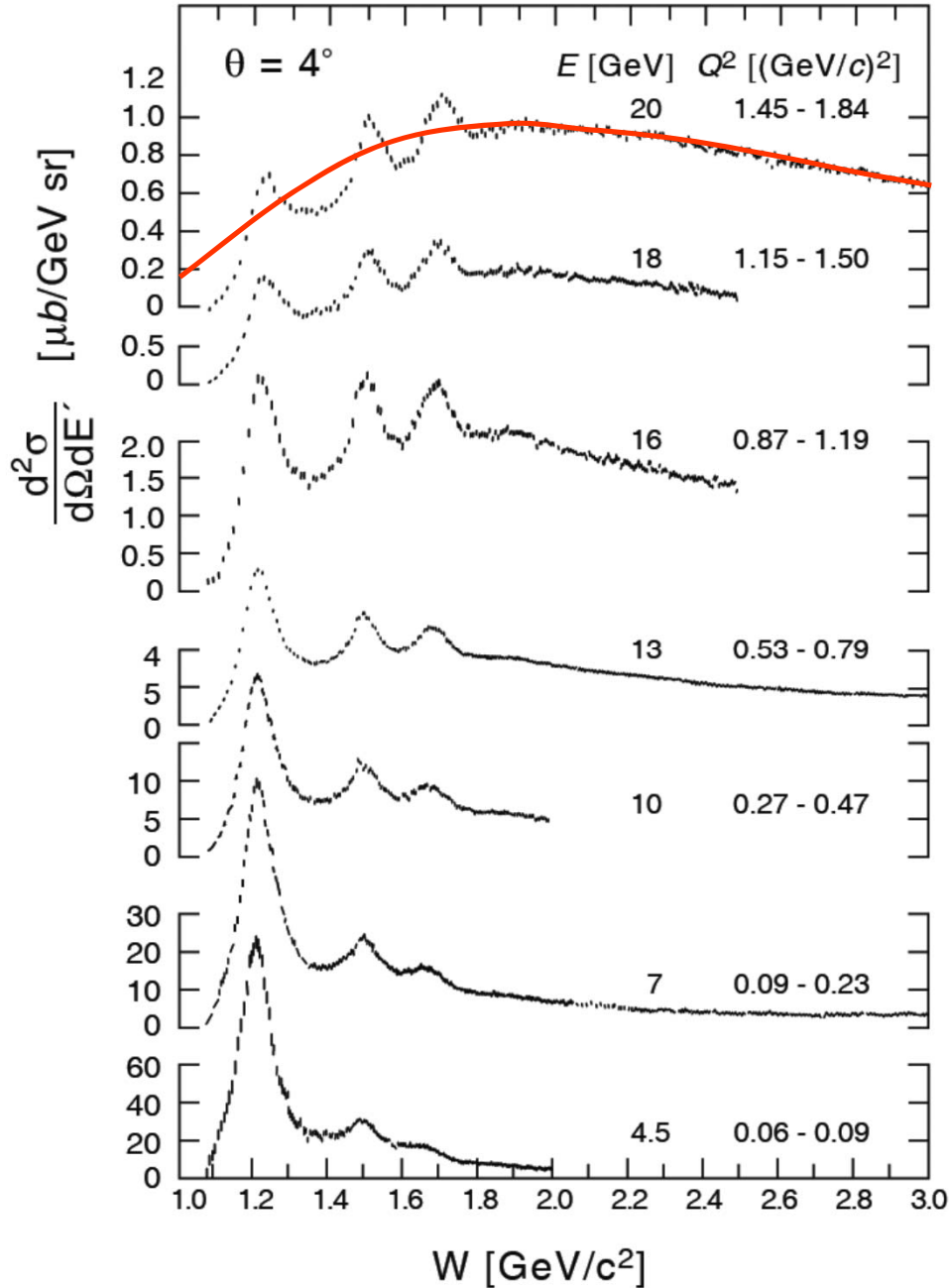

hard and
confined

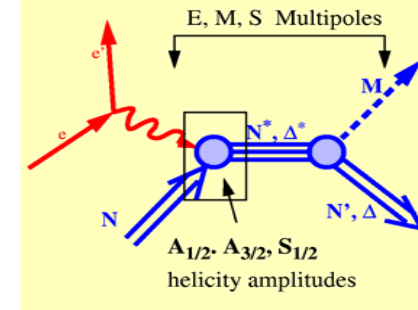

Elastic Form Factors
Transition Form Factors

hard
soft

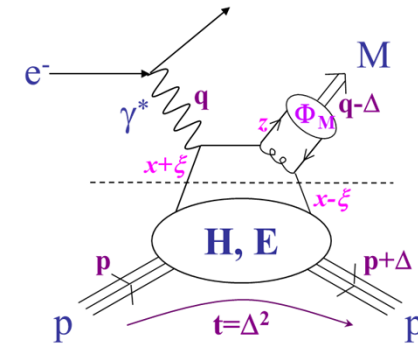

Deep Inelastic Scattering
S. Stein et al., PR **D22** (1975) 1884

Deep Exclusive π^+ Electroproduction off the Proton

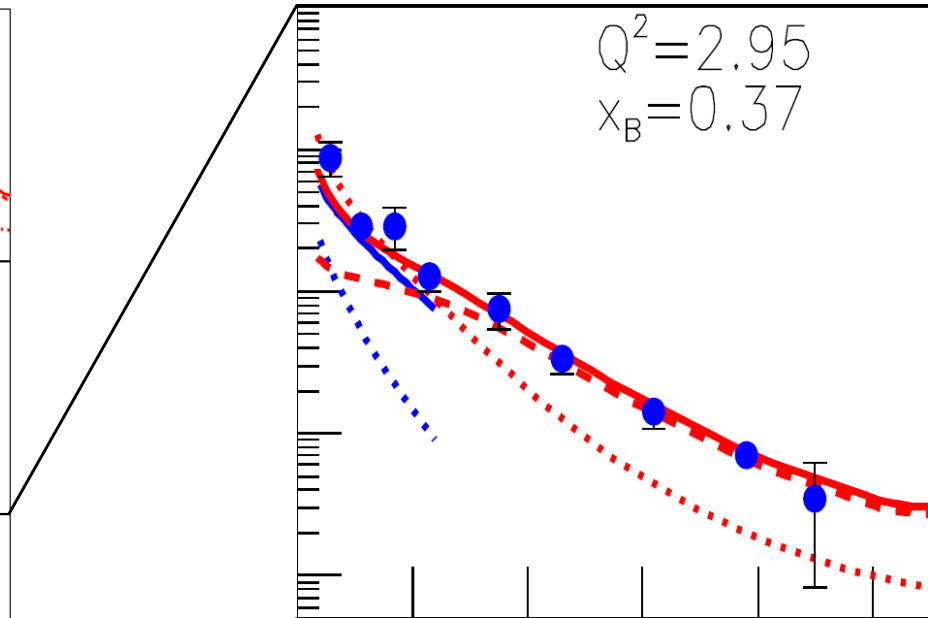
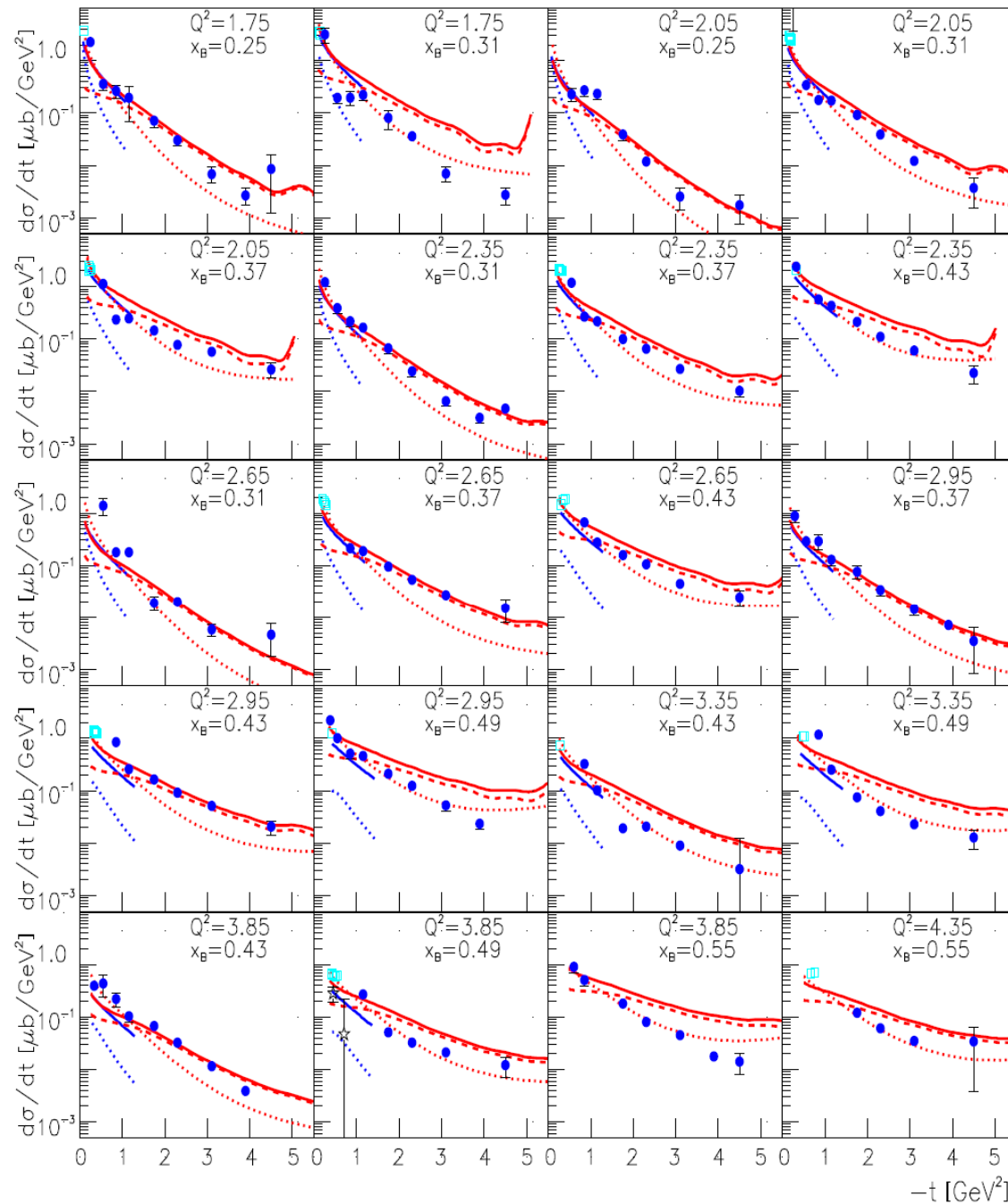

K. Park et al., Eur. Phys. J. A 49 (2013) 16

The **red solid** ($d\sigma/dt$), **dotted** ($d\sigma_L/dt$), and **dashed** ($d\sigma_T/dt$) curves are the calculations from a **hadronic model (Regge phenomenology)** with (Q^2, t) -dependent form factors at the photon-meson vertices. The **blue solid and dotted** curves are the calculations of $d\sigma/dt$ and $d\sigma_L/dt$, respectively, of a **partonic model (handbag diagrams)**.

Transition Form Factors

Small Sample of Recent Calculations

J. Arrington

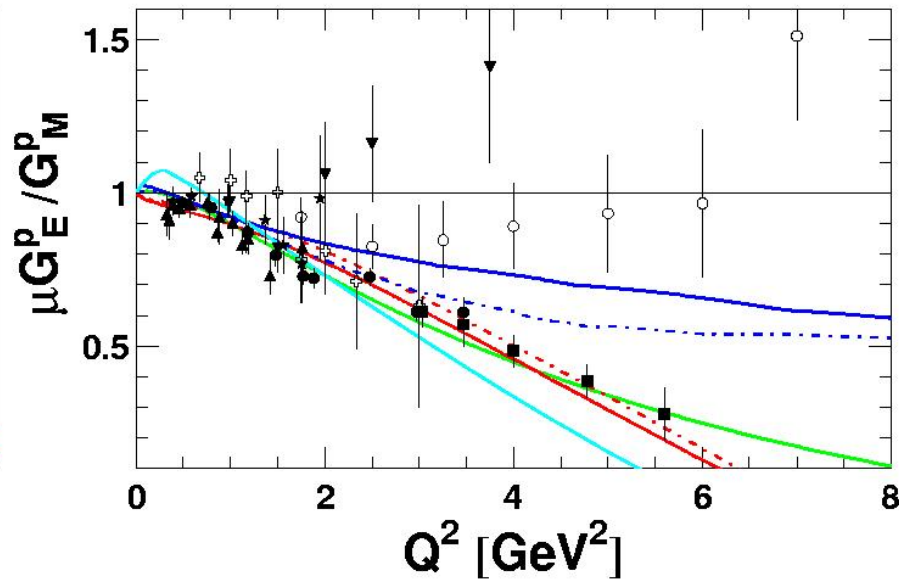
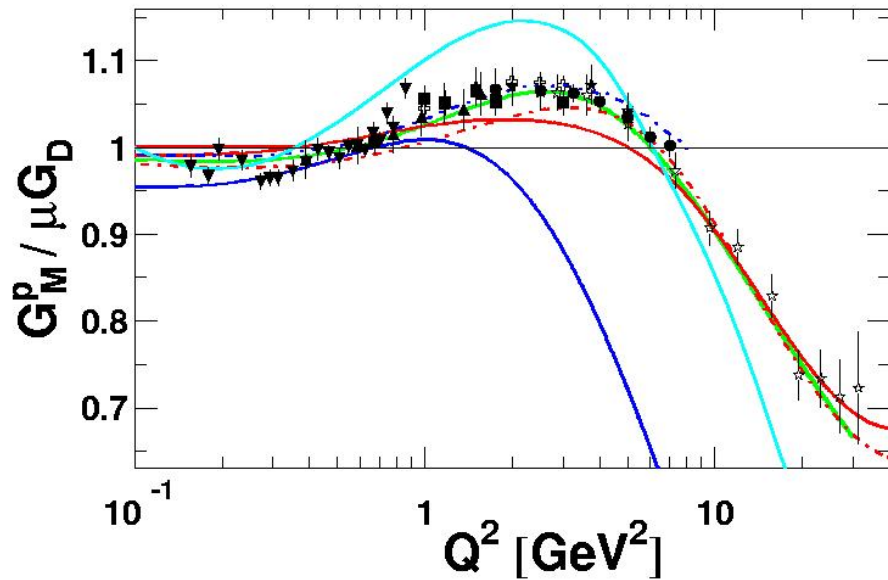

— VMD + pQCD (Lomon 2002)
- - - Soliton (Holzwarth b1)
— Soliton (Holzwarth b2)

— PFSA CQM GBE
- - - LF CQM qFF (Cardarelli)
— LF CQM π (Miller)

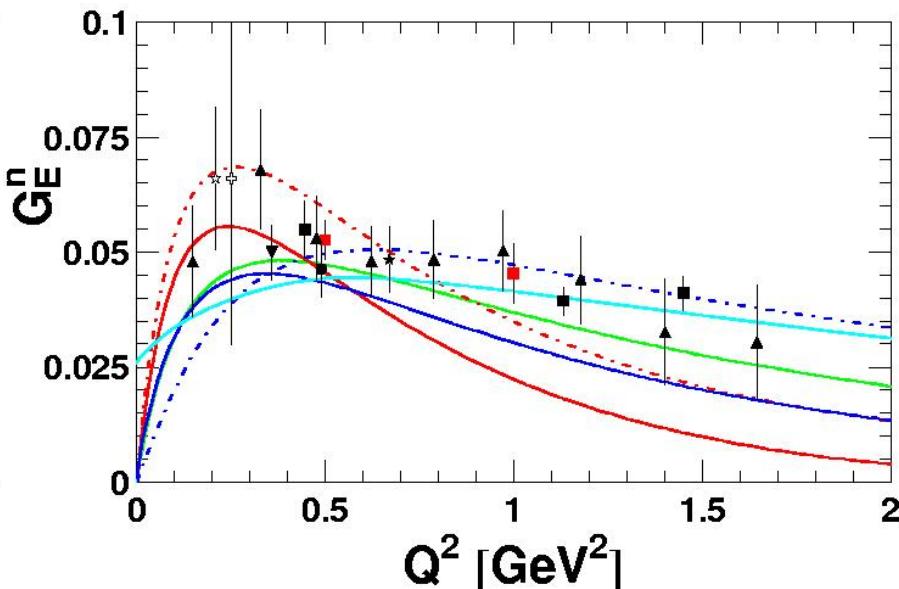
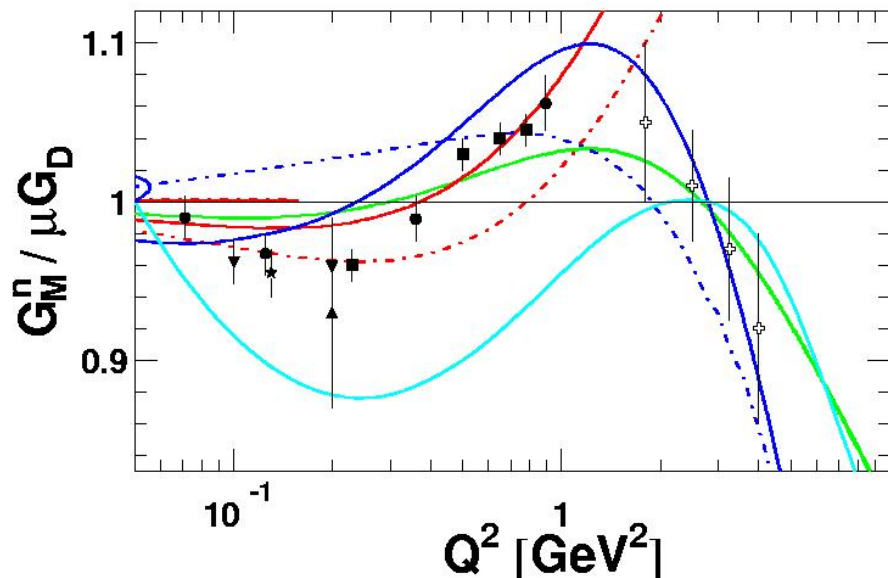

Phenomenological Analyses

- Unitary Isobar Model (UIM) approach in single pseudoscalar meson production
- Fixed- t Dispersion Relations (DR)
- Unitarized Isobar Model for $N\pi\pi$ final state (JM)

Int. J. Mod. Phys. E, Vol. 22, 1330015 (2013) 1-99

- Coupled-Channel Approach
EBAC \Rightarrow Argonne-Osaka
(Jülich \Rightarrow JAW and Bonn-Gatchina ... we are waiting for you ...)

Int. J. Mod. Phys. E, Vol. 22, 1330015 (2013) 1-99

Legendre Moments of Unpolarized Structure Functions

K. Park *et al.* (CLAS), Phys. Rev. C77, 015208 (2008)

$Q^2=2.05\text{GeV}^2$

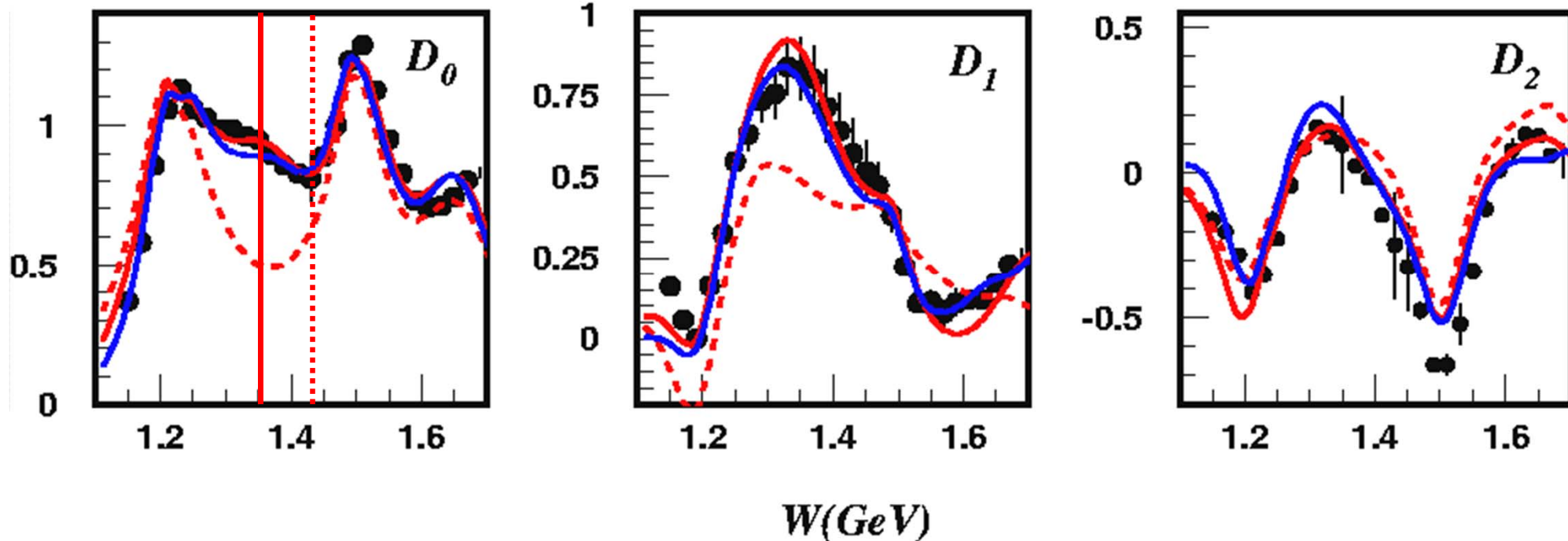

$$\sigma_T + \epsilon\sigma_L = \sum_{l=0}^n D_l^{T+L} P_l(\cos\theta_\pi^*)$$

- I. Aznauryan ——— DR fit
- I. Aznauryan - - - DR fit w/o P_{11}
- I. Aznauryan ——— UIM fit

Two conceptually different approaches
DR and UIM are consistent. CLAS data
provide rigid constraints for checking
validity of the approaches.

$J/\psi \rightarrow p\pi^- \bar{n}$ and $J/\psi \rightarrow \bar{p}\pi^+ n$

BES/BEPC, Phys. Rev. Lett. 97 (2006)

Bing-Song Zou

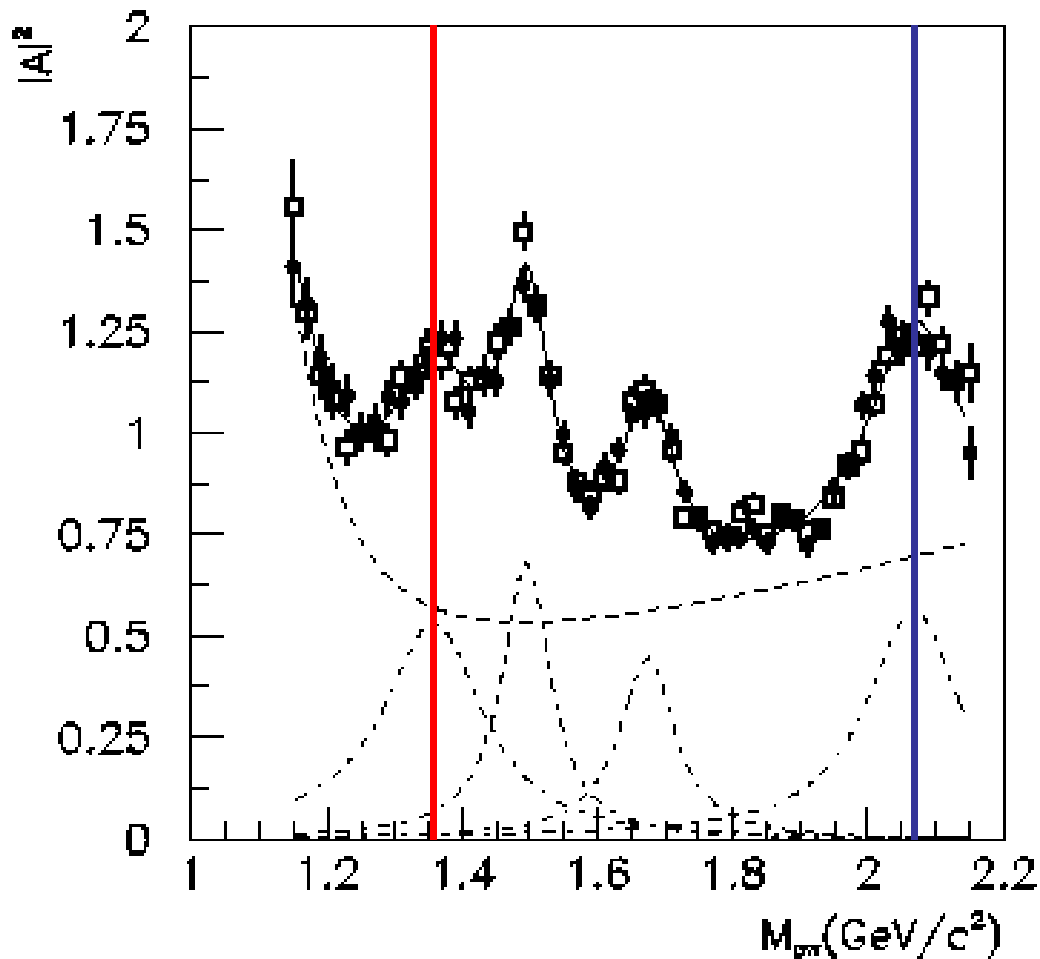

$N^*(1440)$: $M = 1358 \pm 17$
 $\Gamma = 179 \pm 56$

$N^*(2050)$: $M = 2068^{+15}_{-40}$
 $\Gamma = 165 \pm 42$

πN invariant mass / MC phase space

Energy-Dependence of π^+ Multipoles for P_{11} , S_{11}

The study of some baryon resonances becomes easier at higher Q^2 .

Cross sections are extracted in the $p\pi^0$, $p\pi^+$, $p\eta$; and more are currently under analysis in the $p\omega$ and $p\pi^-$ final states.

$Q^2 = 0 \text{ GeV}^2$

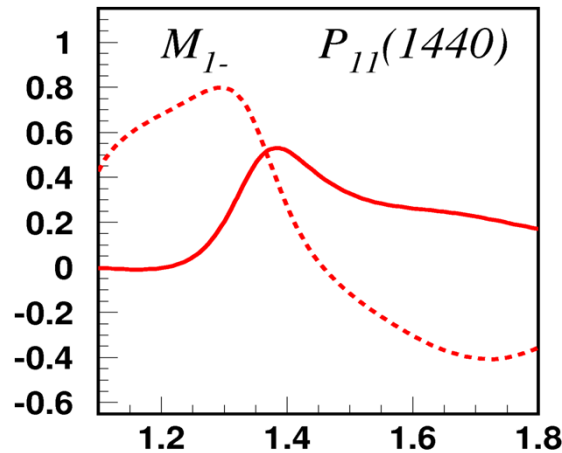

$Q^2 = 2.05 \text{ GeV}^2$

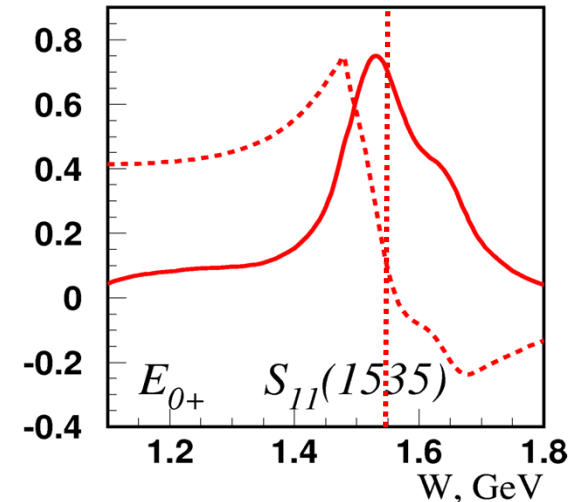
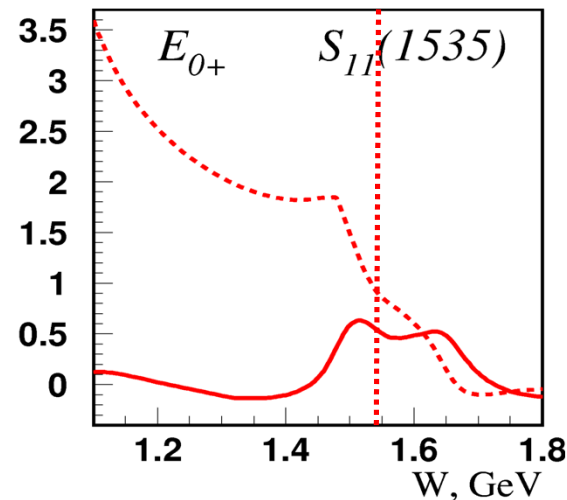
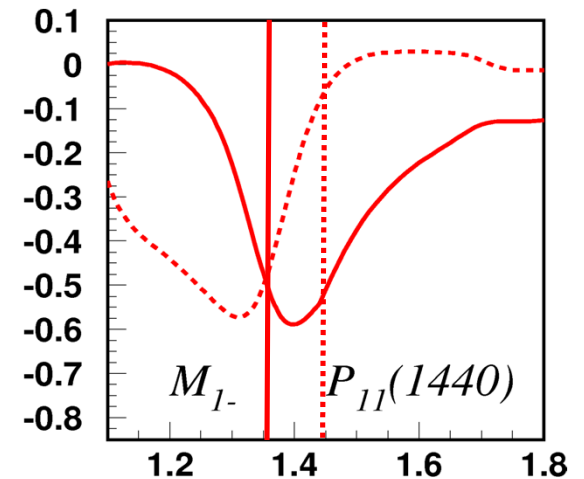

..... real part

———— imaginary part

Hadron Structure with Electromagnetic Probes

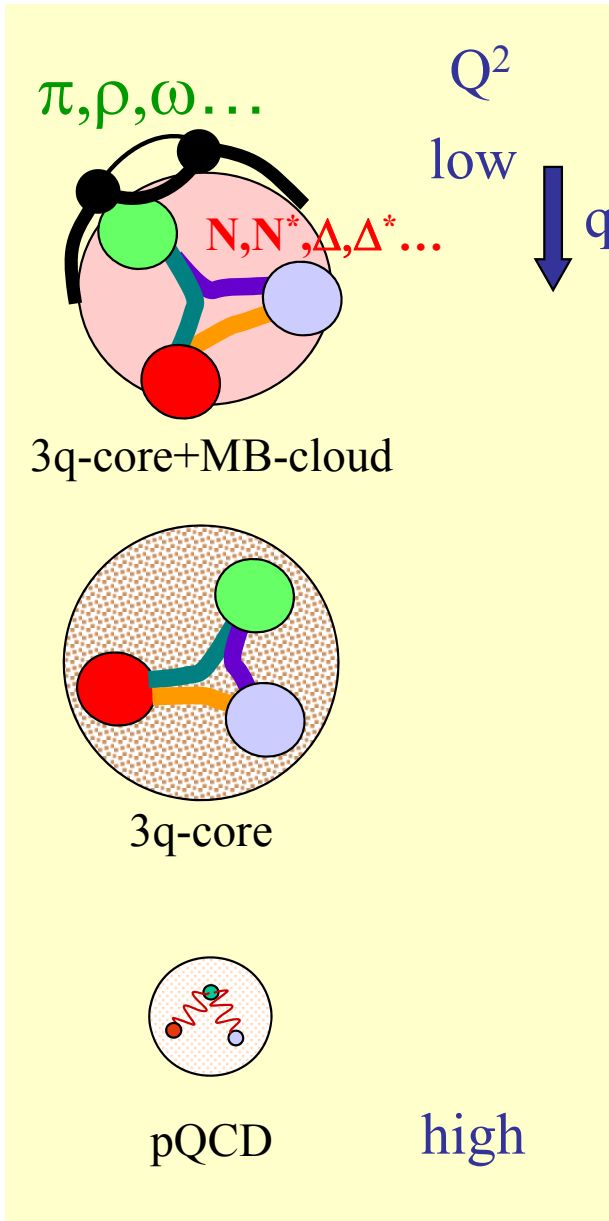

- Study the structure of the nucleon spectrum in the domain where dressed quarks are the major active degree of freedom.
- Explore the formation of excited nucleon states in interactions of dressed quarks and their emergence from QCD.

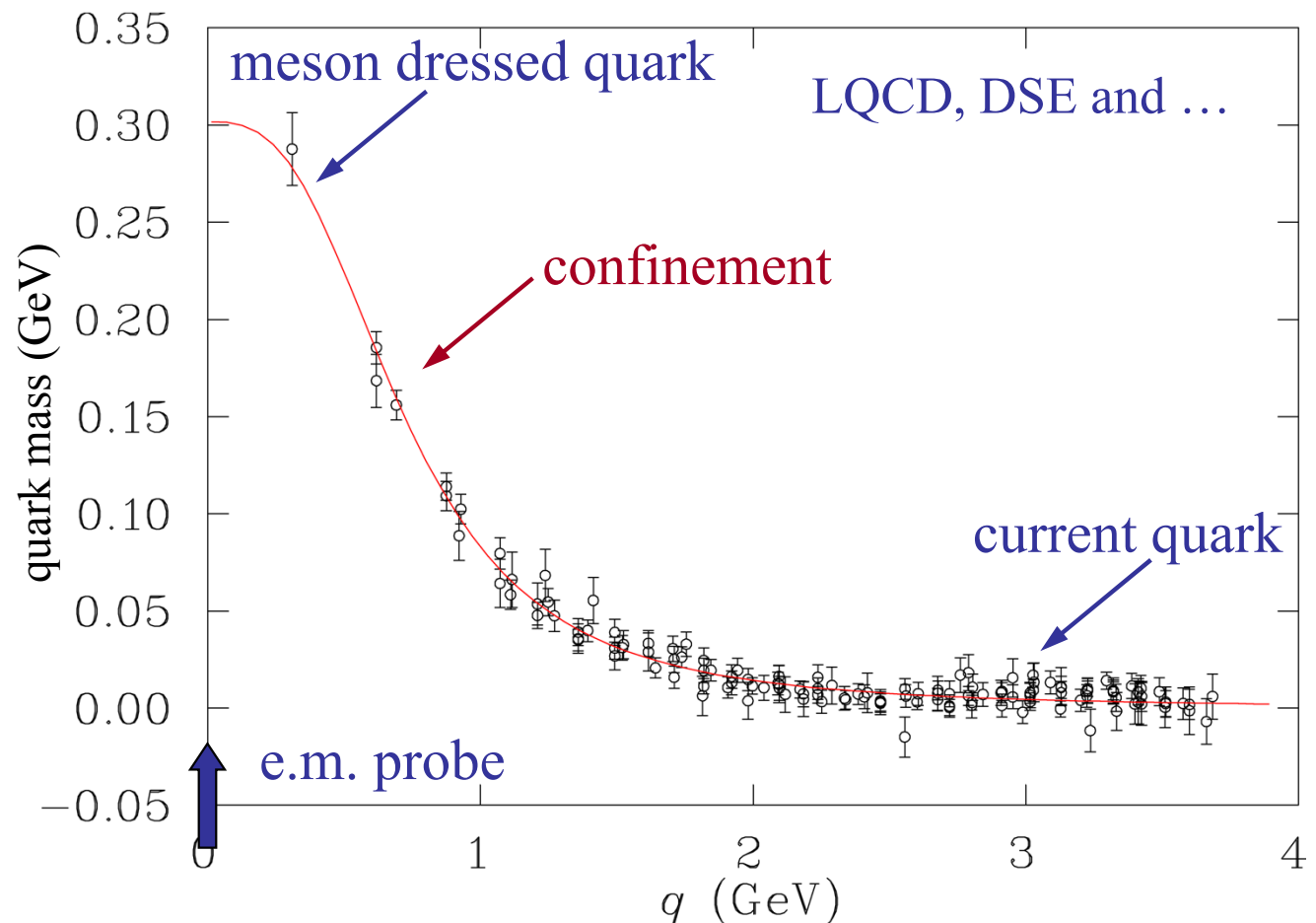

Evidence for the Onset of Scaling?

Phys. Rev. C80, 055203 (2009)

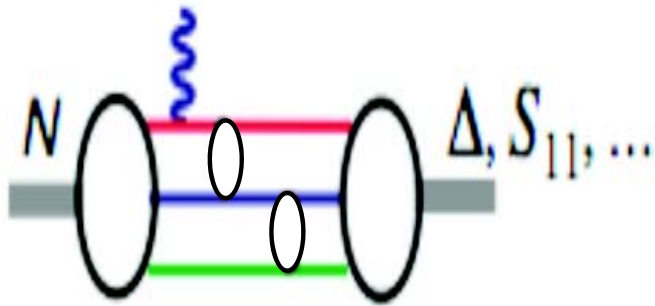

➤ $A_{1/2} \propto 1/Q^3$

➤ $A_{3/2} \propto 1/Q^5$

➤ $G_M^* \propto 1/Q^4$

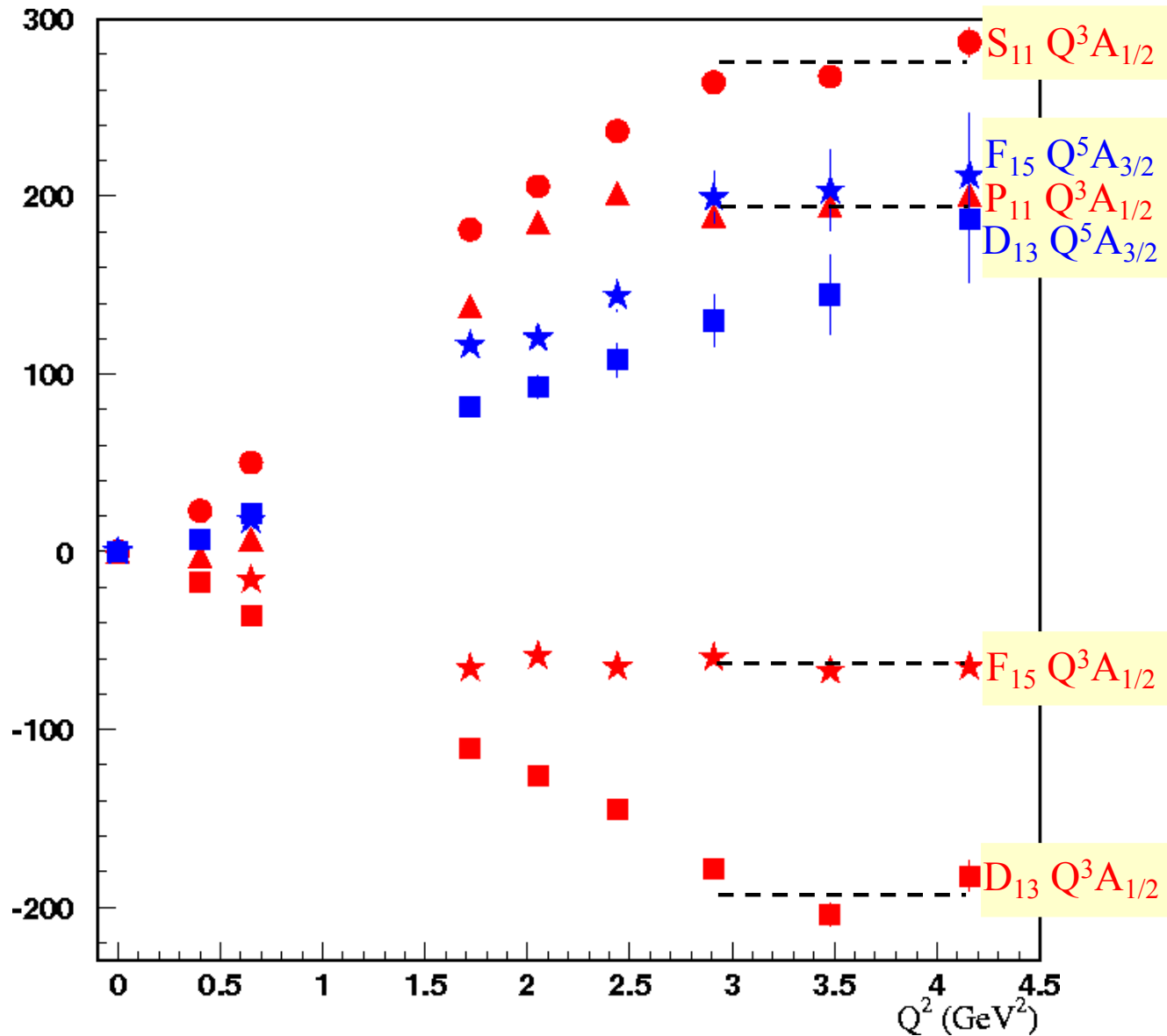

$N \rightarrow \Delta$ Multipole Ratios R_{EM} , R_{SM}

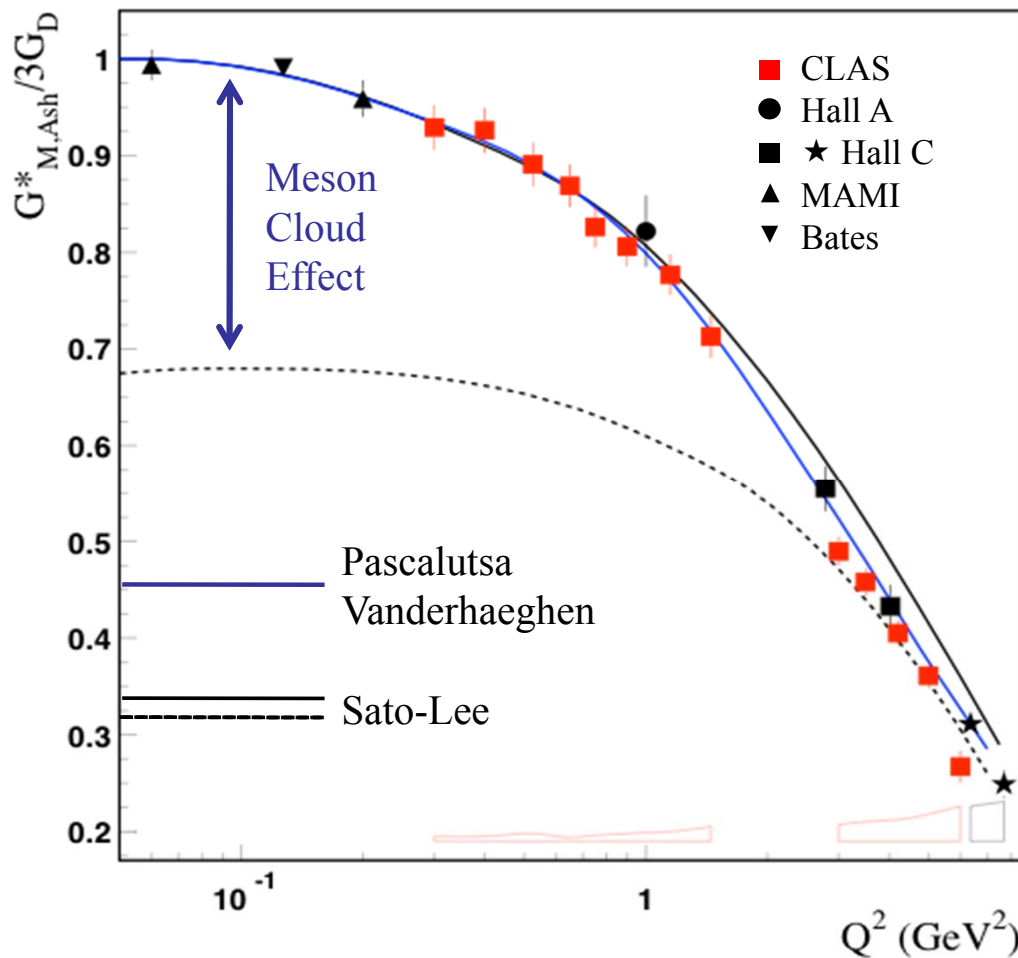

Phys. Rev. Lett. 97, 112003 (2006)

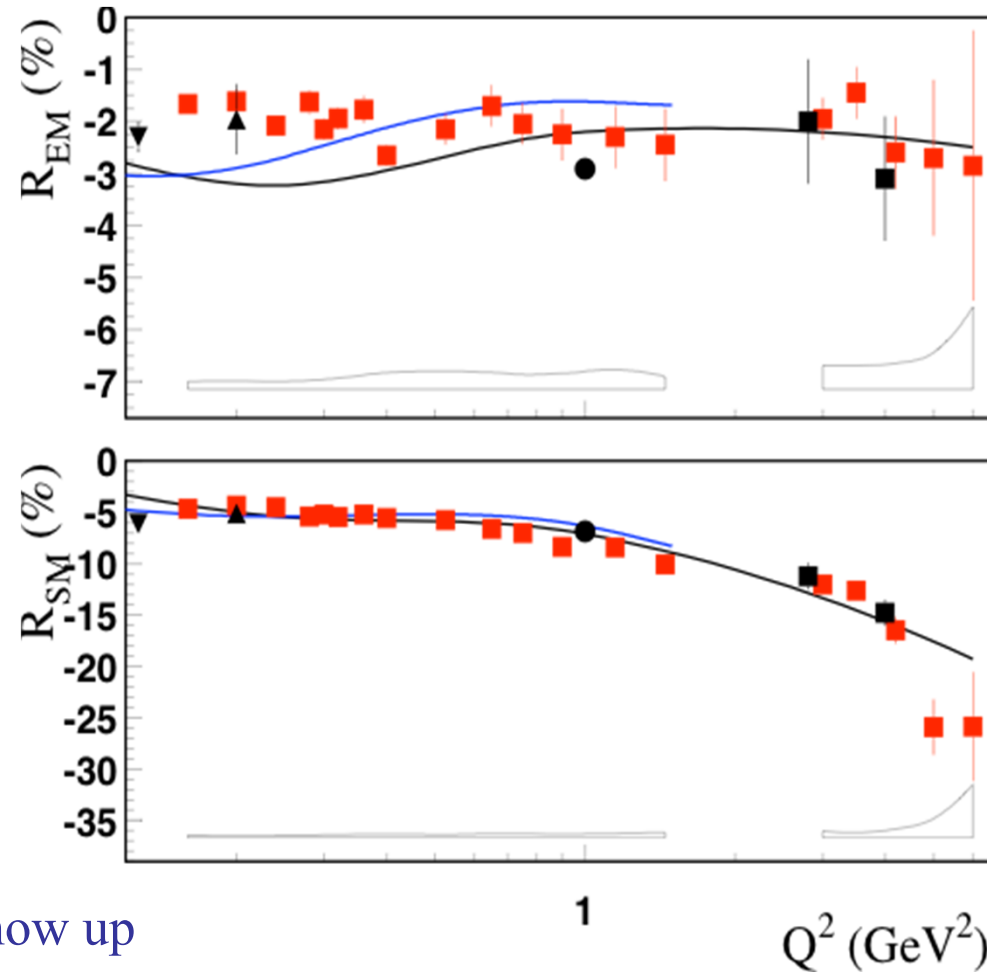

➤ New trend towards pQCD behavior **does not** show up

➤ $R_{EM} \rightarrow +1$ $R_{SM} \rightarrow \text{const}$

➤ $G_M^* \rightarrow 1/Q^4$ $G_{M,Ash}^* \rightarrow 1/Q^5$

➤ CLAS12 can measure G_M^* , R_{EM} , and R_{SM} up to $Q^2 \sim 12 \text{ GeV}^2$

Inclusive Structure Function in the Resonance Region

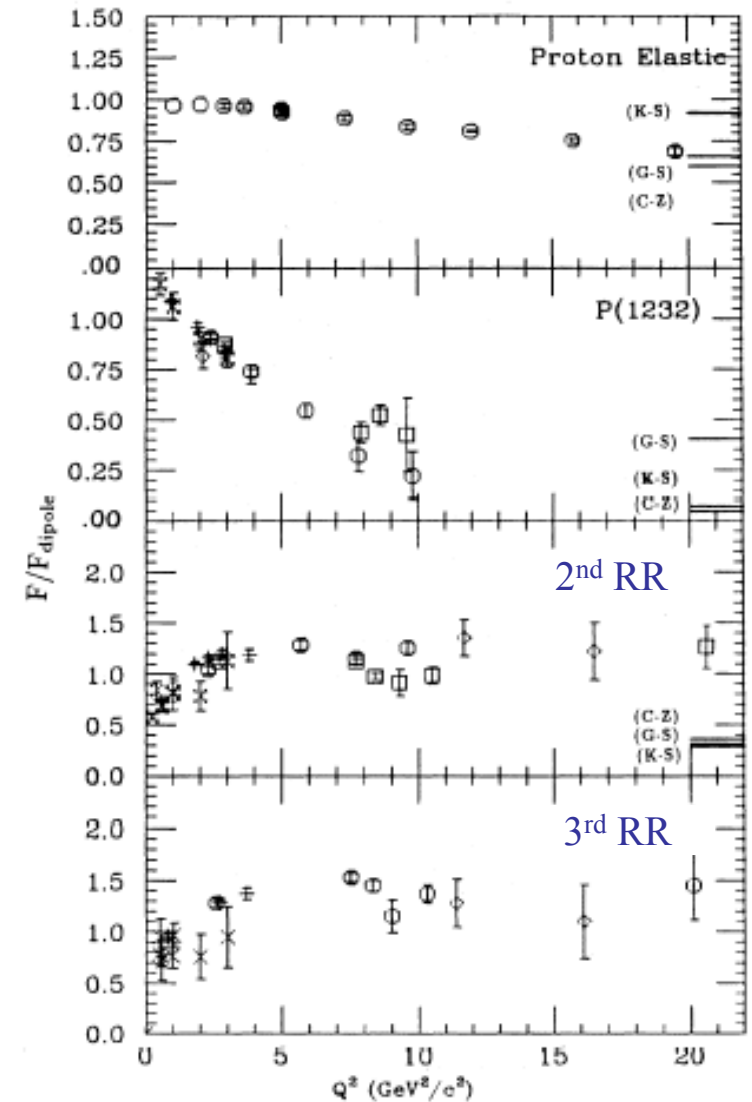
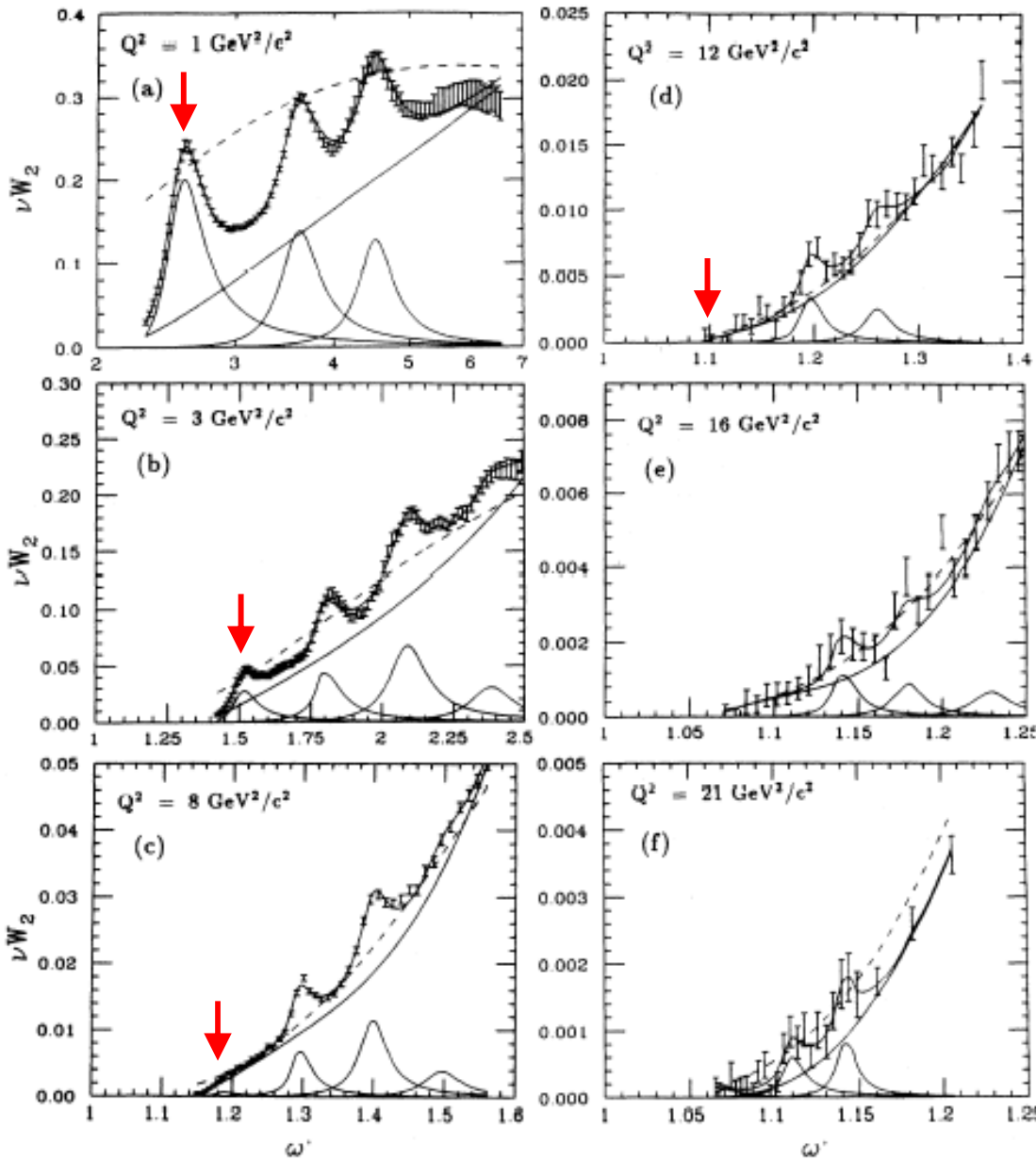

P. Stoler, PRPLCM 226, 3 (1993) 103-171

Nucleon Resonances in $N\pi$ and $N\pi\pi$ Electroproduction

$$Q^2 < 4.0 \text{ GeV}^2$$

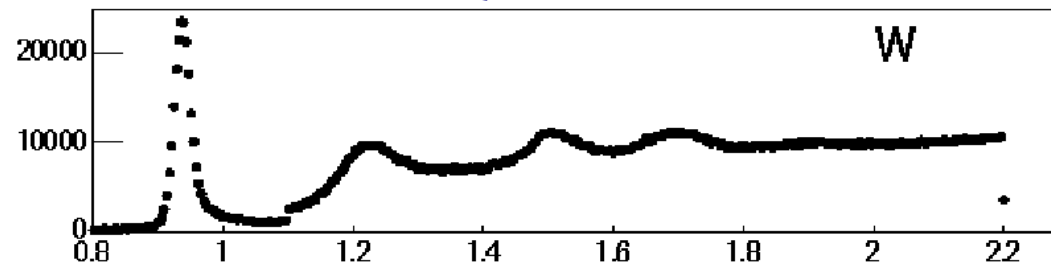

$p(e,e')X$

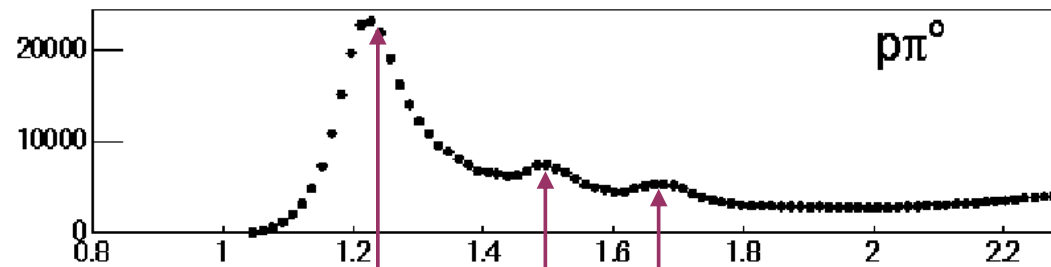

$p(e,e'p)\pi^0$

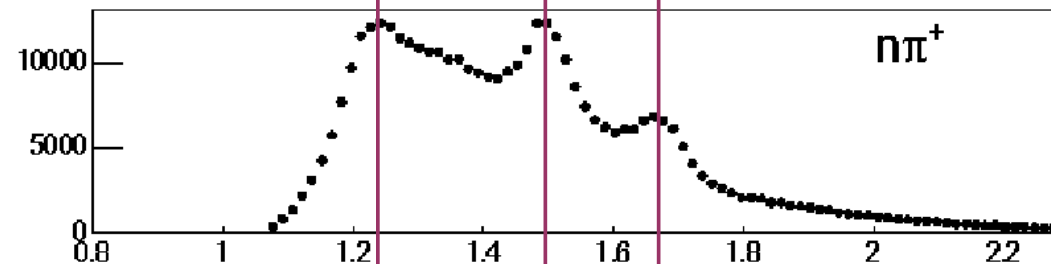

$p(e,e'\pi^+)n$

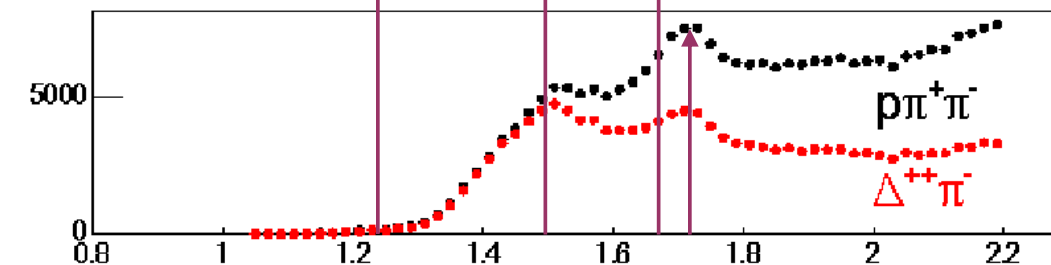

$p(e,e'p\pi^+)\pi^-$

W in GeV

- $N\pi\pi$ channel is sensitive to N^* 's heavier than 1.4 GeV
- Provides information that is complementary to the $N\pi$ channel
- Many higher-lying N^* 's decay preferentially into $N\pi\pi$ final states

Electrocouplings of $N(1440)P_{11}$ from CLAS Data

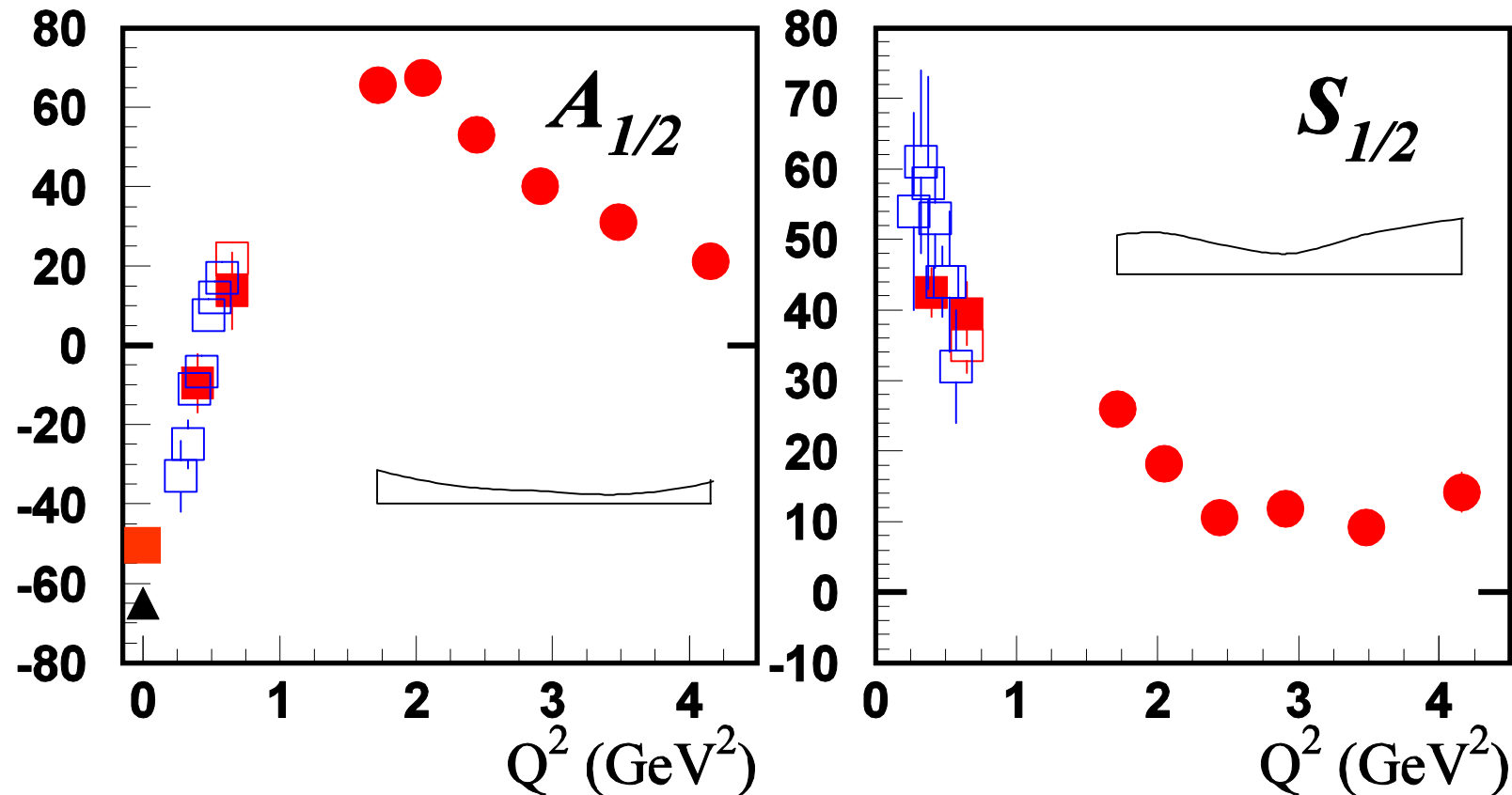

▲ PDG estimation ● ■ $N\pi$ (UIM, DR) □ $N\pi$, $N\pi\pi$ combined analysis □ $N\pi\pi$ (JM)

The good agreement on extracting the N^* electrocouplings between the two exclusive channels ($1\pi/2\pi$) – having fundamentally different mechanisms for the nonresonant background – provides evidence for the reliable extraction of N^* electrocouplings.

Phys. Rev. C 86, 035203 (2012) 1-22

Most recent Electrocouplings of $N(1440)P_{11}$

Gleb Fedotov

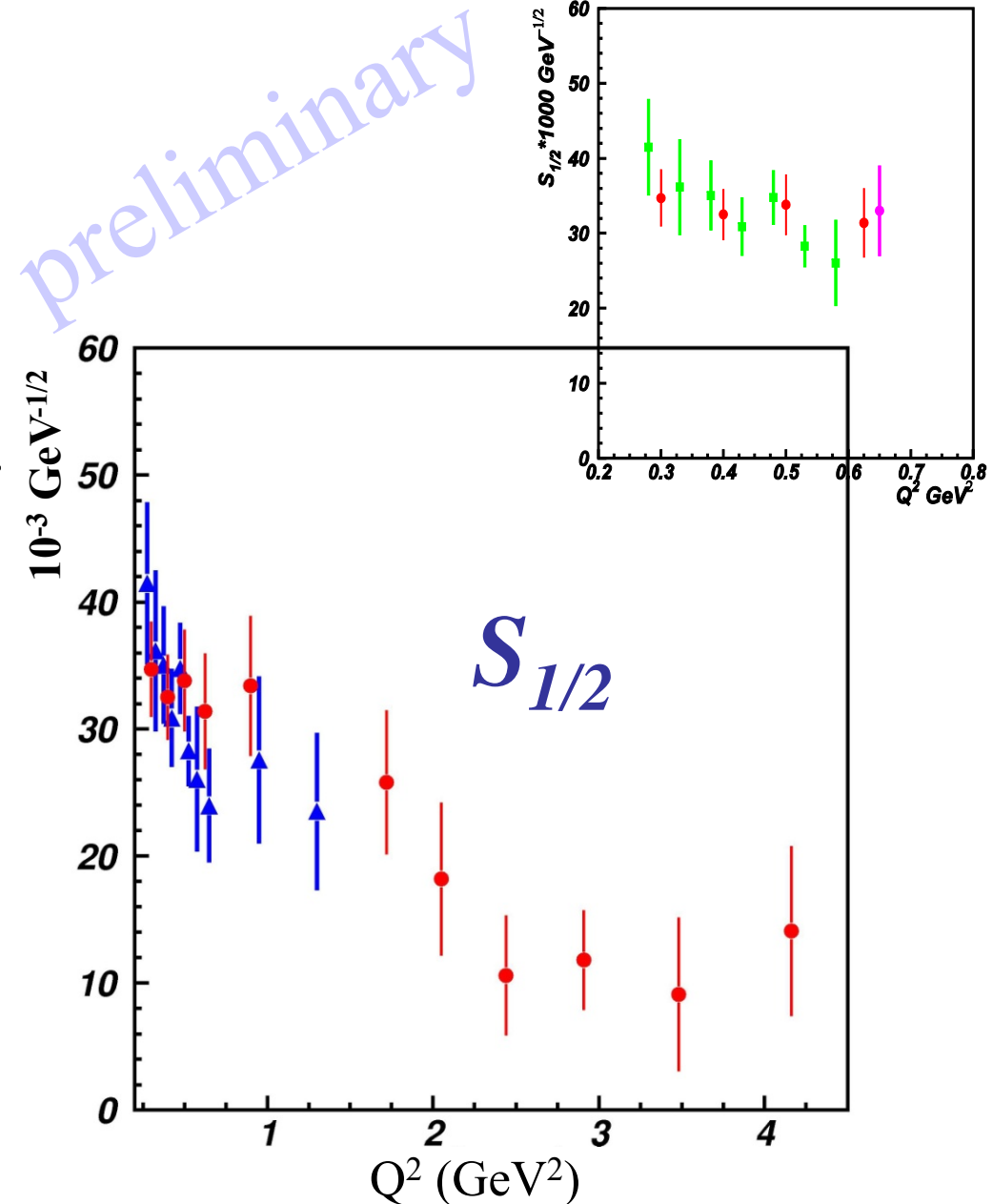
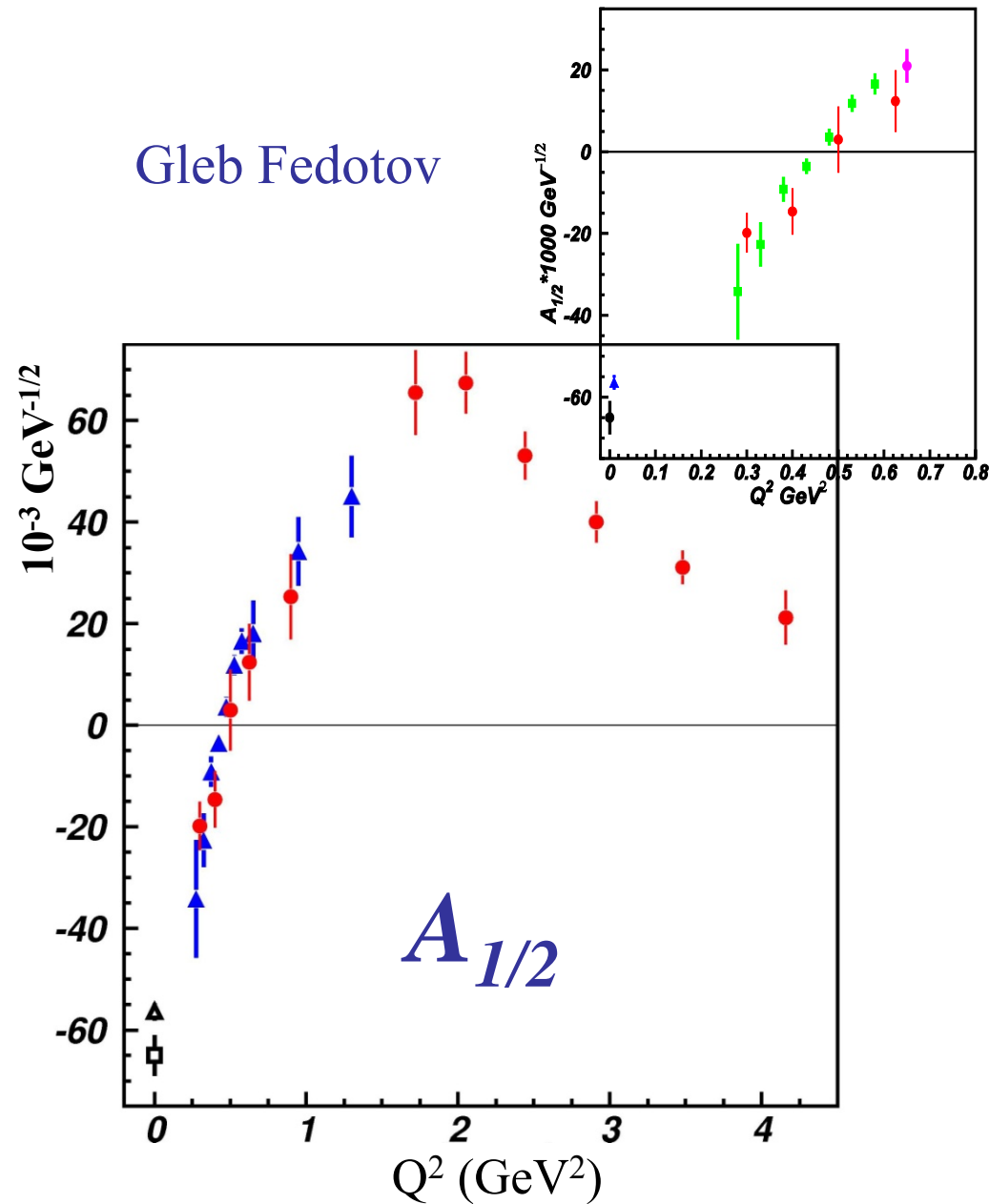

... and beam-helicity dependent 2π cross sections are currently under analysis.

N(1520)D₁₃ Helicity Asymmetry

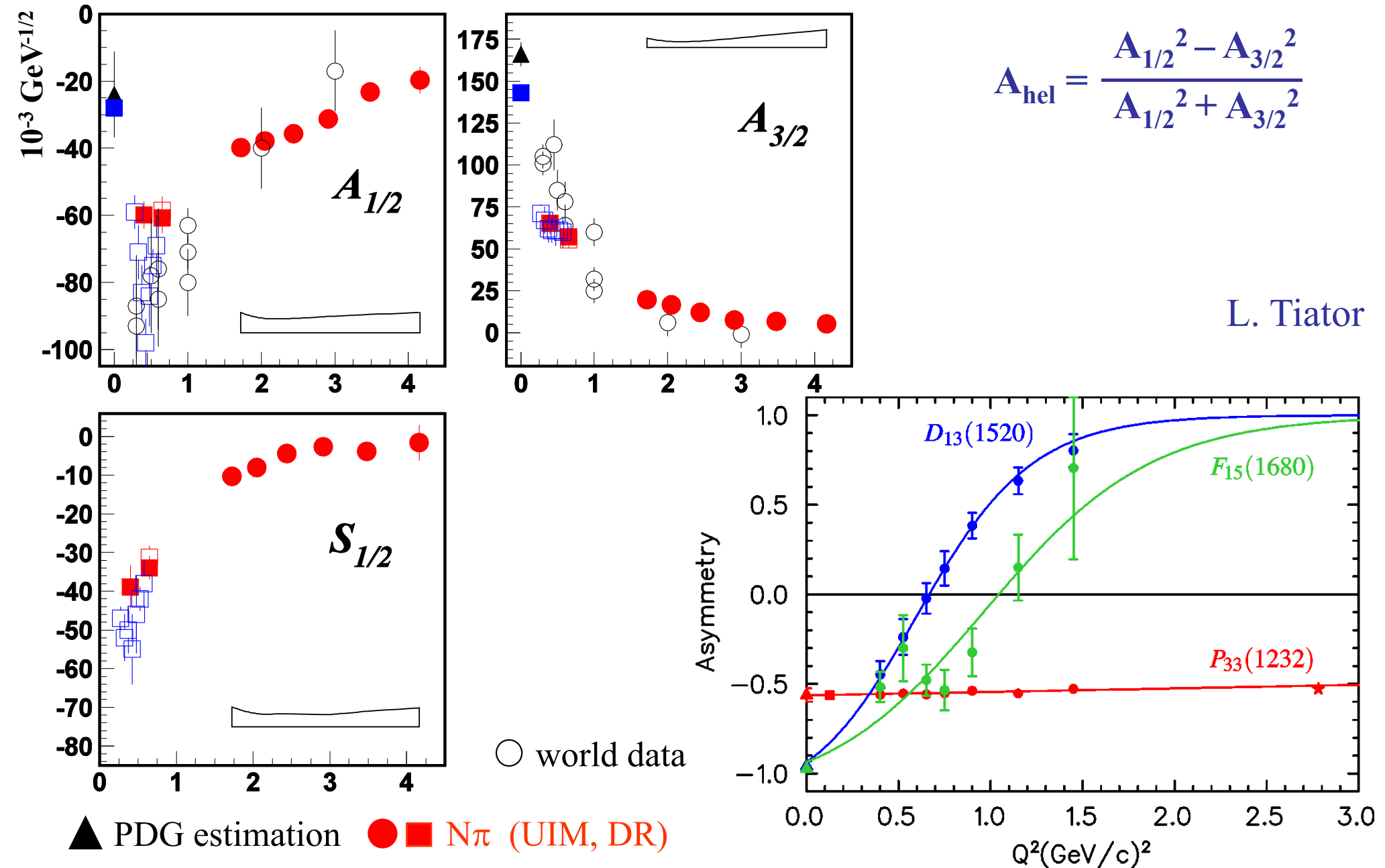

High-Lying Resonance in $N\pi\pi$ CLAS Data Analysis

 $N\pi$ world

 $N\pi\pi$ CLAS preliminary

 $N\pi$ CLAS ($Q^2 = 0$)

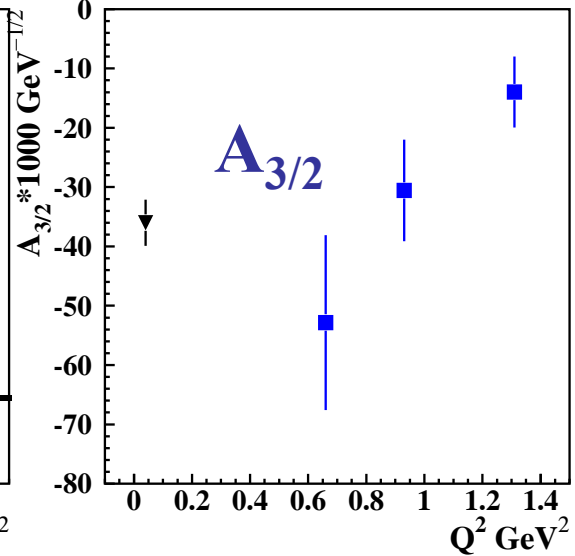
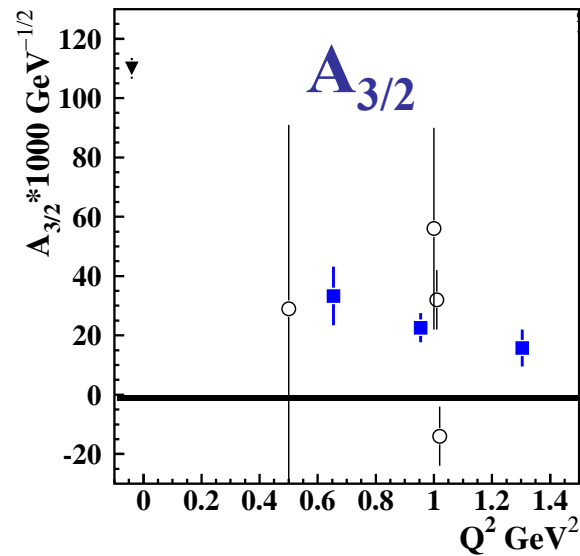
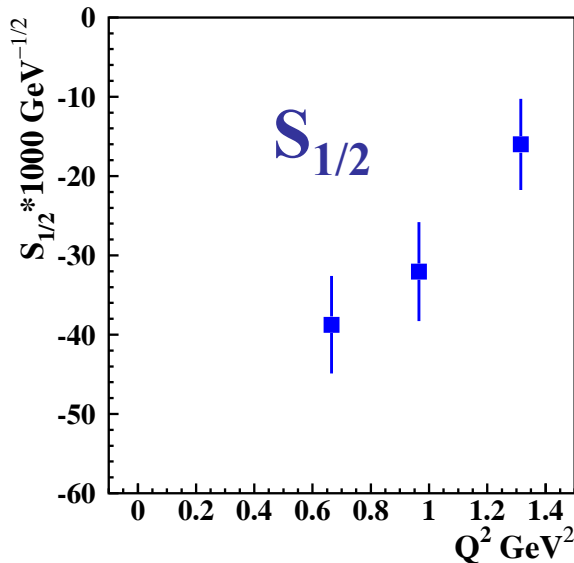
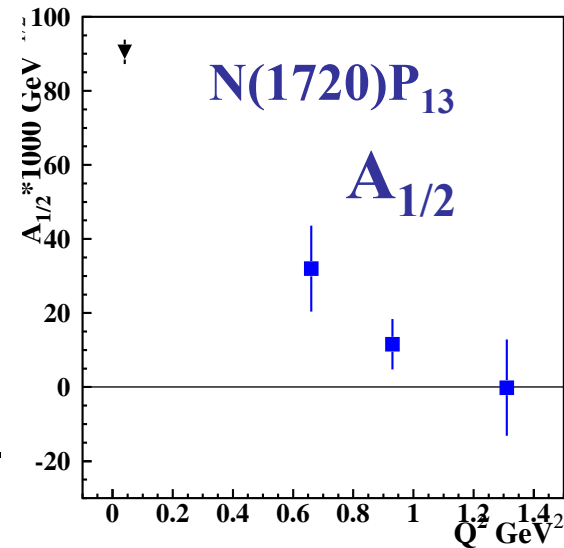
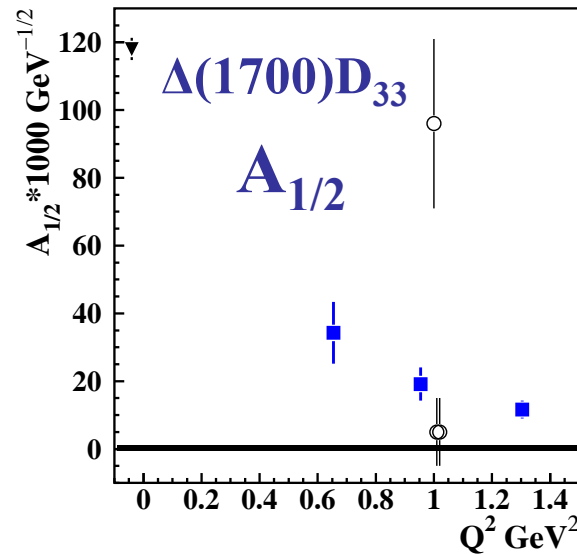
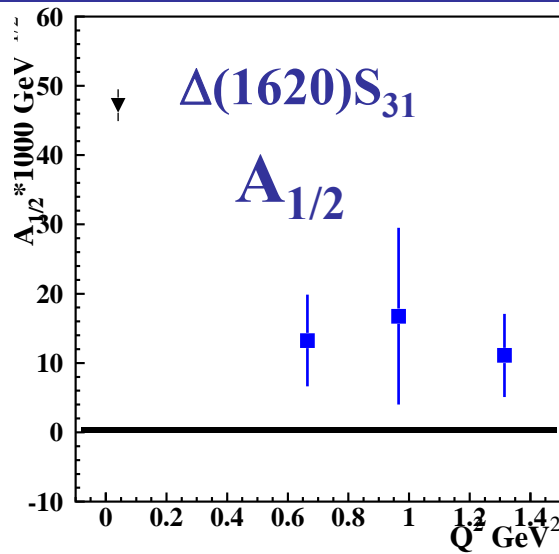

- $\pi^+\pi^-p$ electroproduction channel provided first preliminary results on $S_{31}(1620)$, $S_{11}(1650)$, $F_{15}(1685)$, $D_{33}(1700)$, and $P_{13}(1720)$ electrocouplings of a good accuracy
- new features: a) $S_{1/2}$ dominance for $S_{31}(1620)$ and b) $|A_{3/2}| \geq |A_{1/2}|$ for $D_{33}(1700)$ and $P_{13}(1720)$

QCD-Based

Models and Theory?

Constituent Quark Models (CQM)

With Roper resonance $P_{11}(1440)$ data

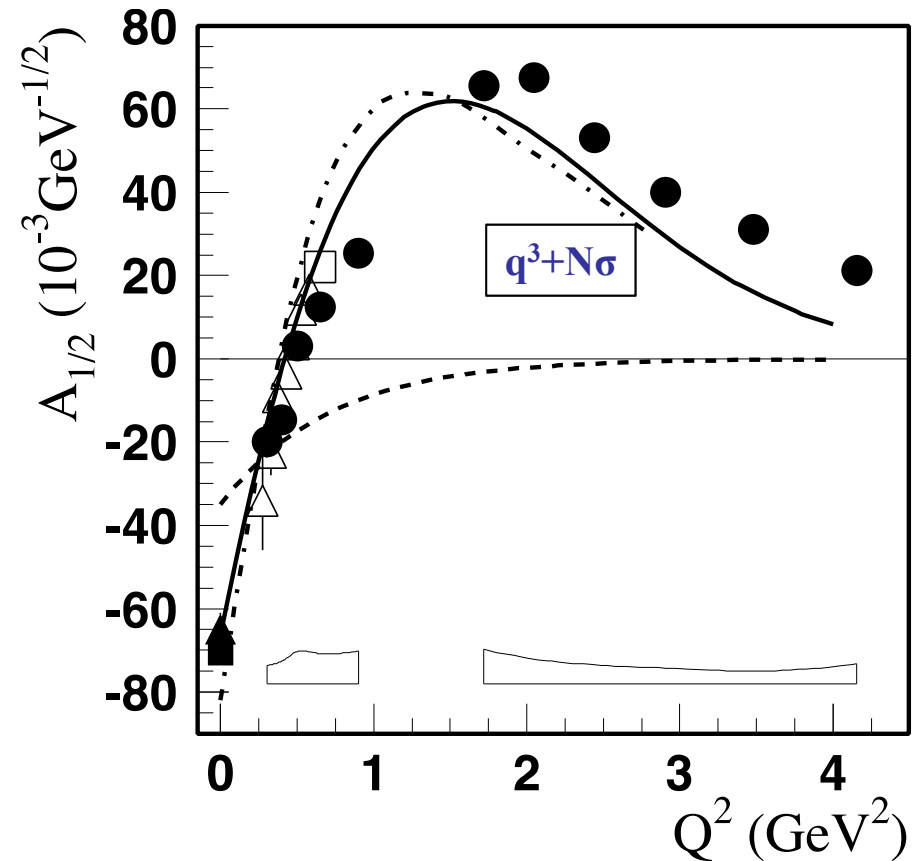
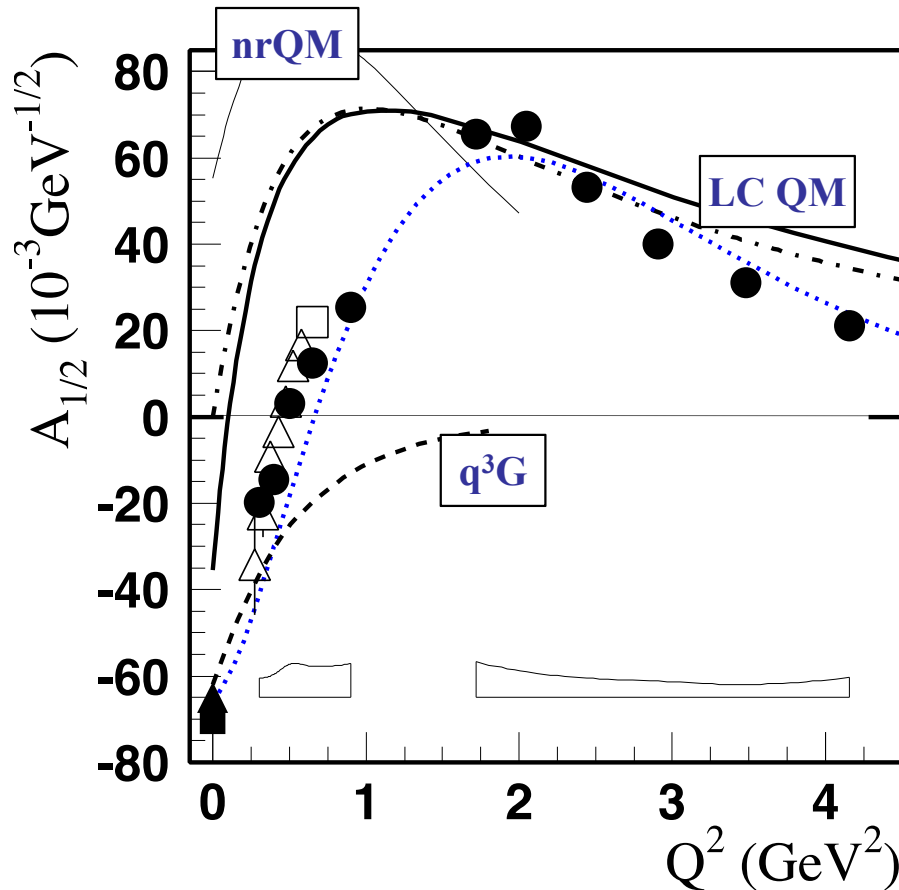

- $A_{1/2}$ has zero-crossing near $Q^2=0.5$ and becomes dominant amplitude at high Q^2
- Eliminates gluonic excitation (q^3G) as a dominant contribution
- Consistent with radial excitation at high Q^2 and large meson-baryon coupling at small Q^2

Progress in Experiment and Phenomenology

Meson-Baryon Dressing

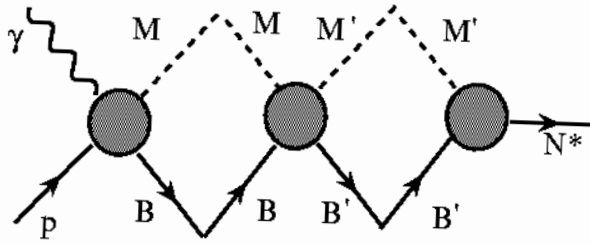

- absolute meson-baryon
- - - cloud amplitudes (EBAC now ANL-Osaka)
- quark core contributions (constituent quark models)

$D_{13}(1520)$

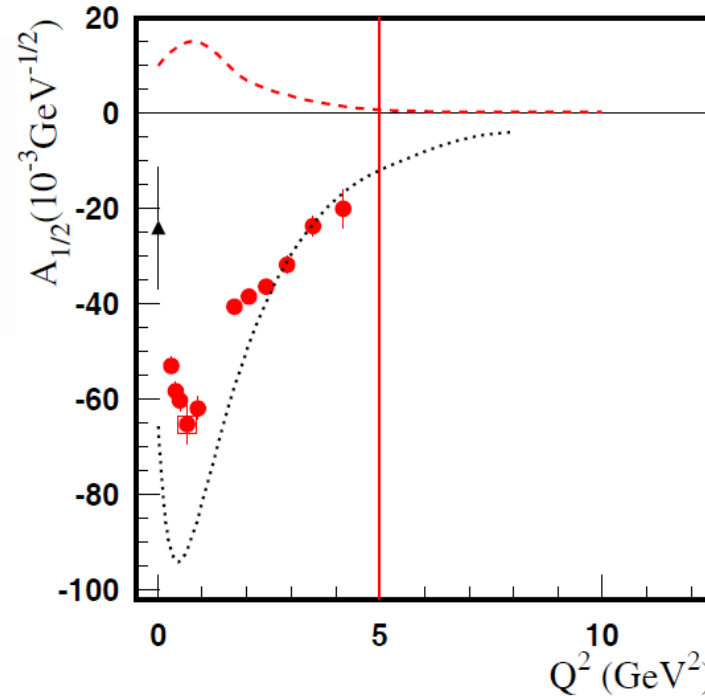

$P_{11}(1440)$

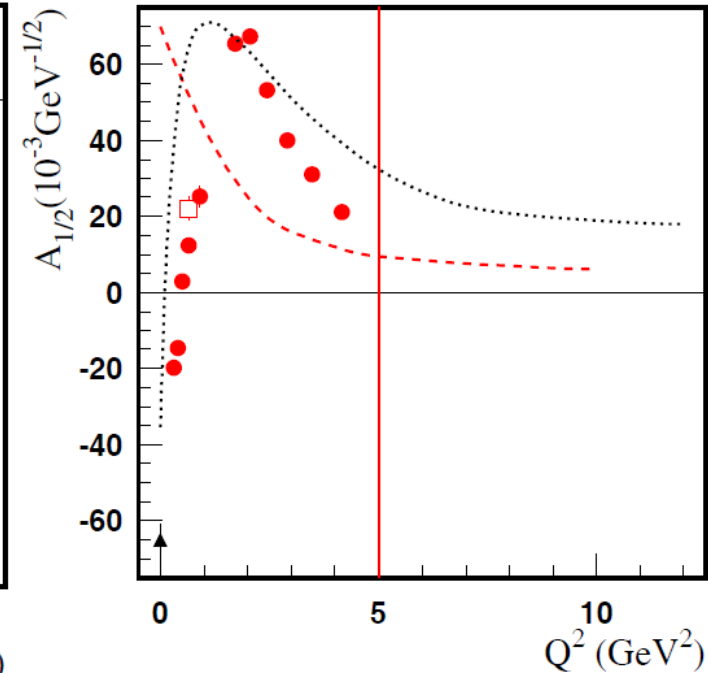

CLAS: $N\pi$  and $N\pi/N\pi\pi$  combined (Phys. Rev. C80, 055203, 2009)

- Resonance structures can be described in terms of an internal quark core and a surrounding meson-baryon cloud whose relative contribution decreases with increasing Q^2 .
- Data on $\gamma_v NN^*$ electrocouplings from this experiment ($Q^2 > 5 \text{ GeV}^2$) will afford for the first time direct access to the **non-perturbative strong interaction among dressed quarks**, their emergence from QCD, and the subsequent N^* formation.

Electrocouplings of $N(1520)D_{13}$

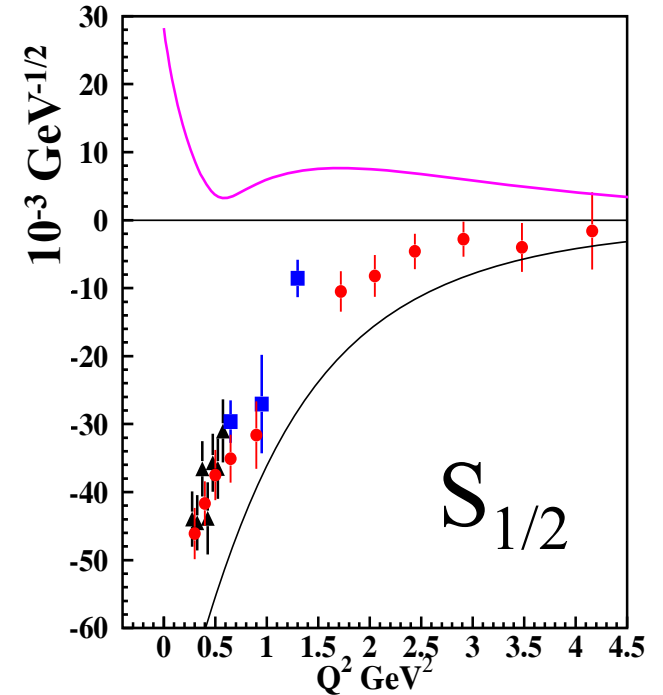
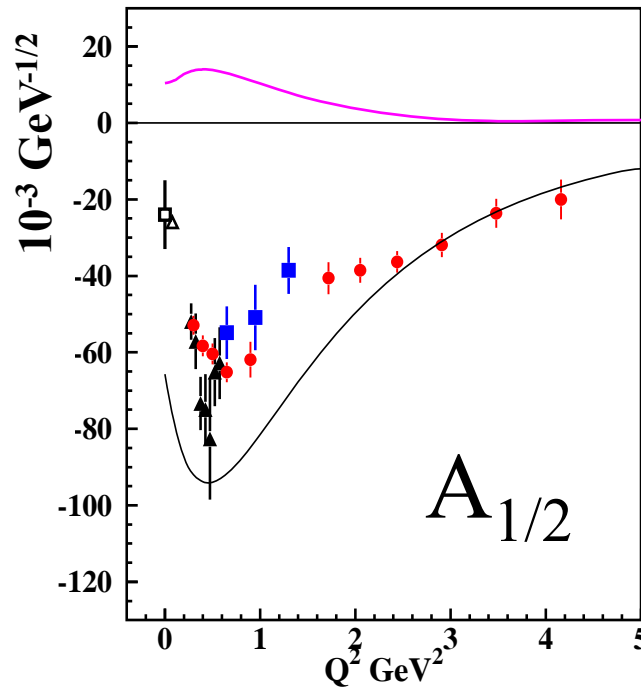
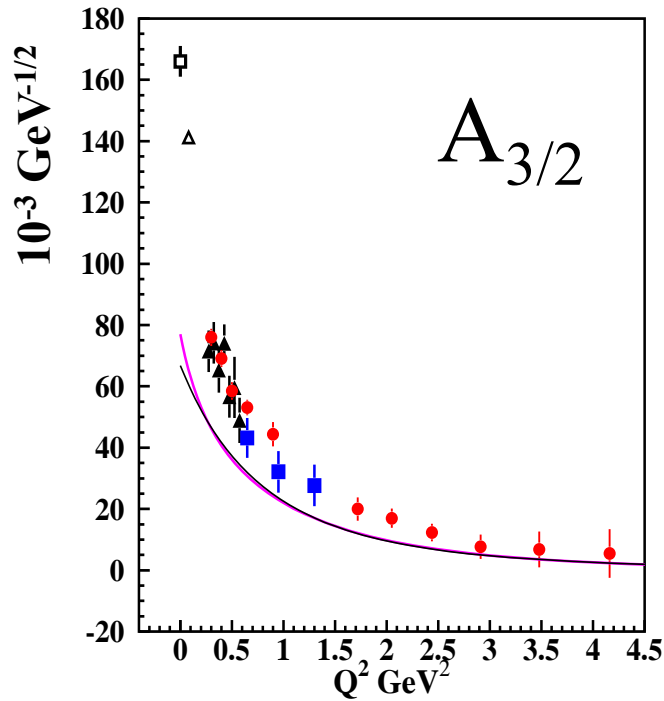

— Argonne Osaka / EBAC DCC MB dressing
(absolute values)

— E.Santopinto, M.Giannini, hCQM
PRC 86, 065202 (2012)

— S.Capstick, B.D.Keister (rCQM)
PRD51, 3598 (1995)

■ $\pi^+\pi^-p$
2012

▲ $\pi^+\pi^-p$
2010

● $N\pi$
2009

Dynamical Mass of Light Dressed Quarks

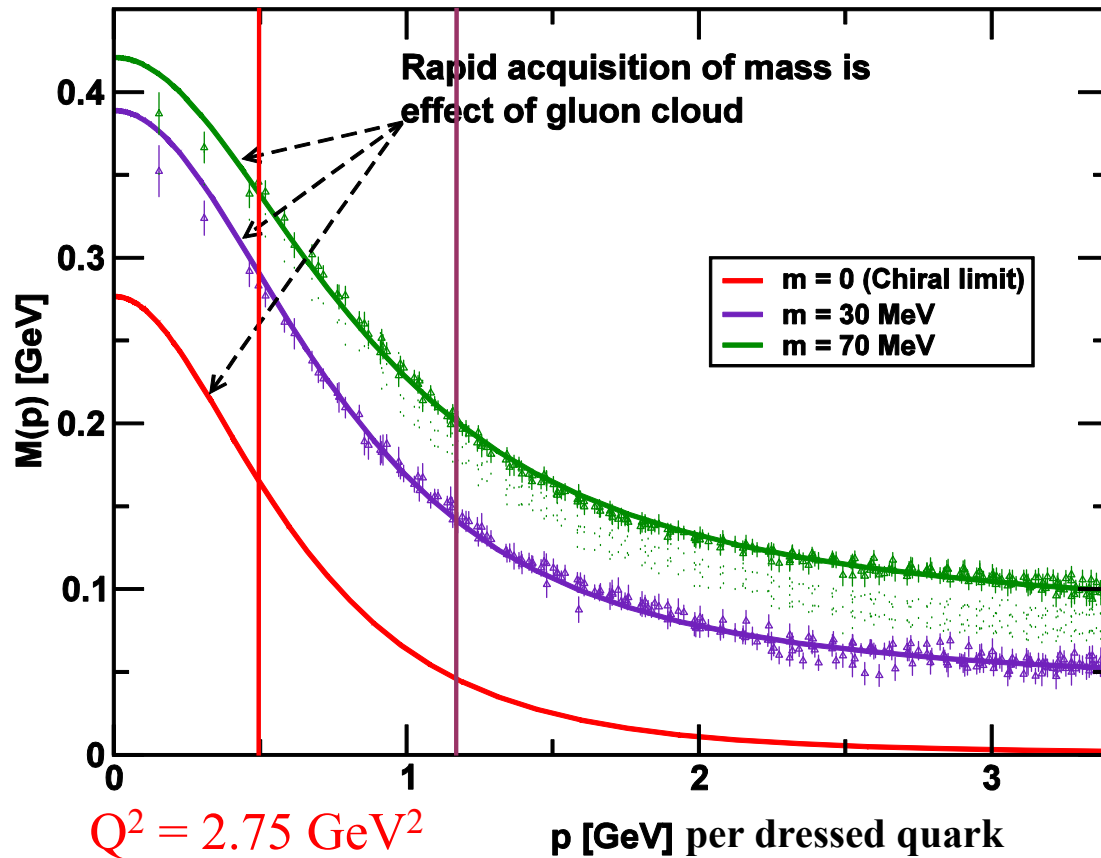

DSE and LQCD predict the dynamical generation of the momentum dependent dressed quark mass that comes from the gluon dressing of the current quark propagator.

These dynamical contributions account for more than 98% of the dressed light quark mass.

DSE: lines and LQCD: triangles

$$Q^2 = 12 \text{ GeV}^2 = (p \text{ times number of quarks})^2 = 12 \text{ GeV}^2 \rightarrow p = 1.15 \text{ GeV}$$

The data on N^* electrocouplings at $5 \text{ GeV}^2 < Q^2 < 12 \text{ GeV}^2$ will allow us to chart the momentum evolution of dressed quark mass, and in particular, to explore the transition from dressed to almost bare current quarks as shown above.

Dyson-Schwinger Equation (DSE) Approach

DSE approaches provide links between dressed quark propagators, form factors, scattering amplitudes, and QCD.

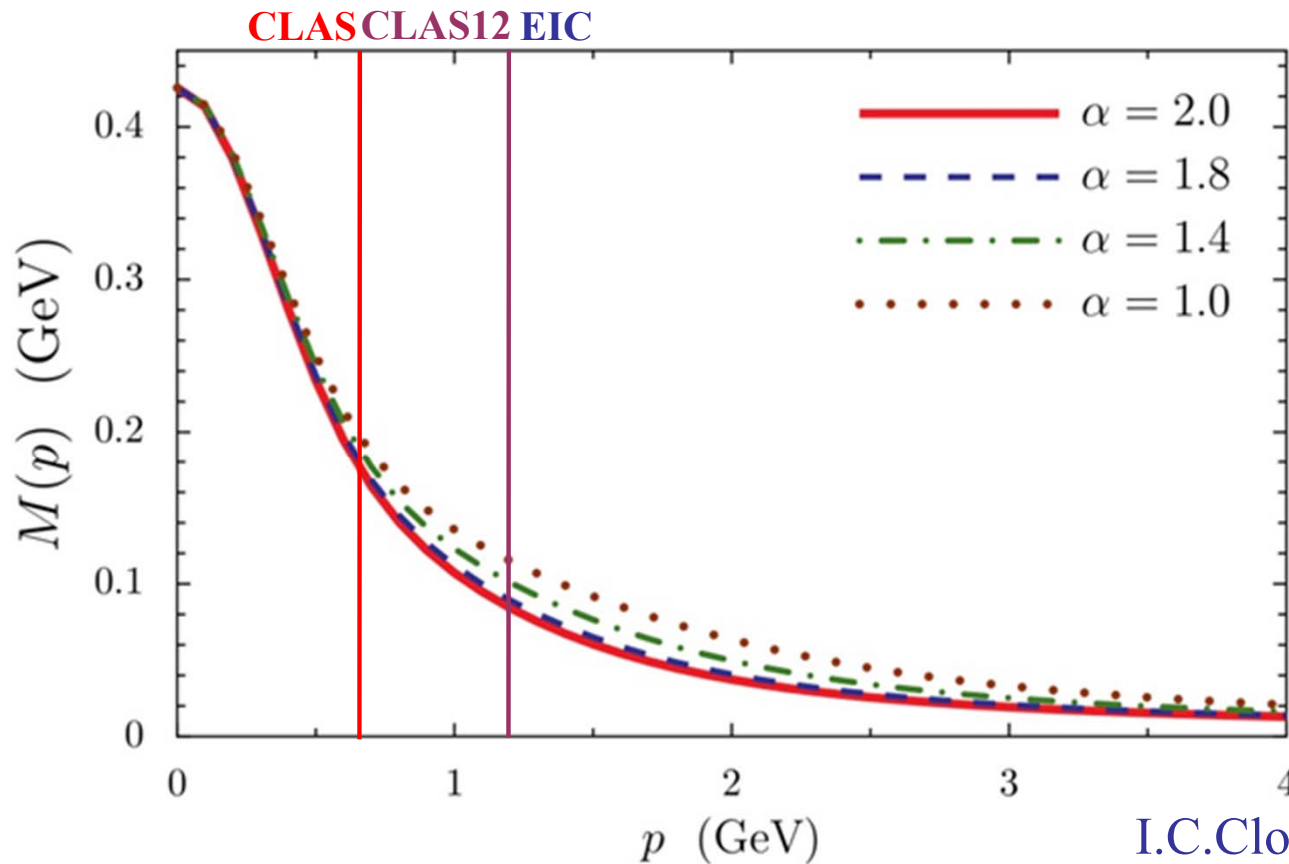

N^* electrocouplings can be determined by applying Bethe-Salpeter / Faddeev equations to 3 dressed quarks while the properties and interactions are derived from QCD.

The Faddeev-DSE calculation is very sensitive to the momentum dependence of the dressed-quark propagator.

I.C.Cloet et al., arXiv:1304.0855[nucl-th]

By the time of the upgrade DSE electrocouplings of several excited nucleon states will be available as part of the commitment of the Argonne NL and the University of Adelaide.

Int. J. Mod. Phys. E, Vol. 22, 1330015 (2013) 1-99

Dyson-Schwinger Equation (DSE) Approach

DSE approaches provide links between dressed quark propagators, form factors, scattering amplitudes, and QCD.

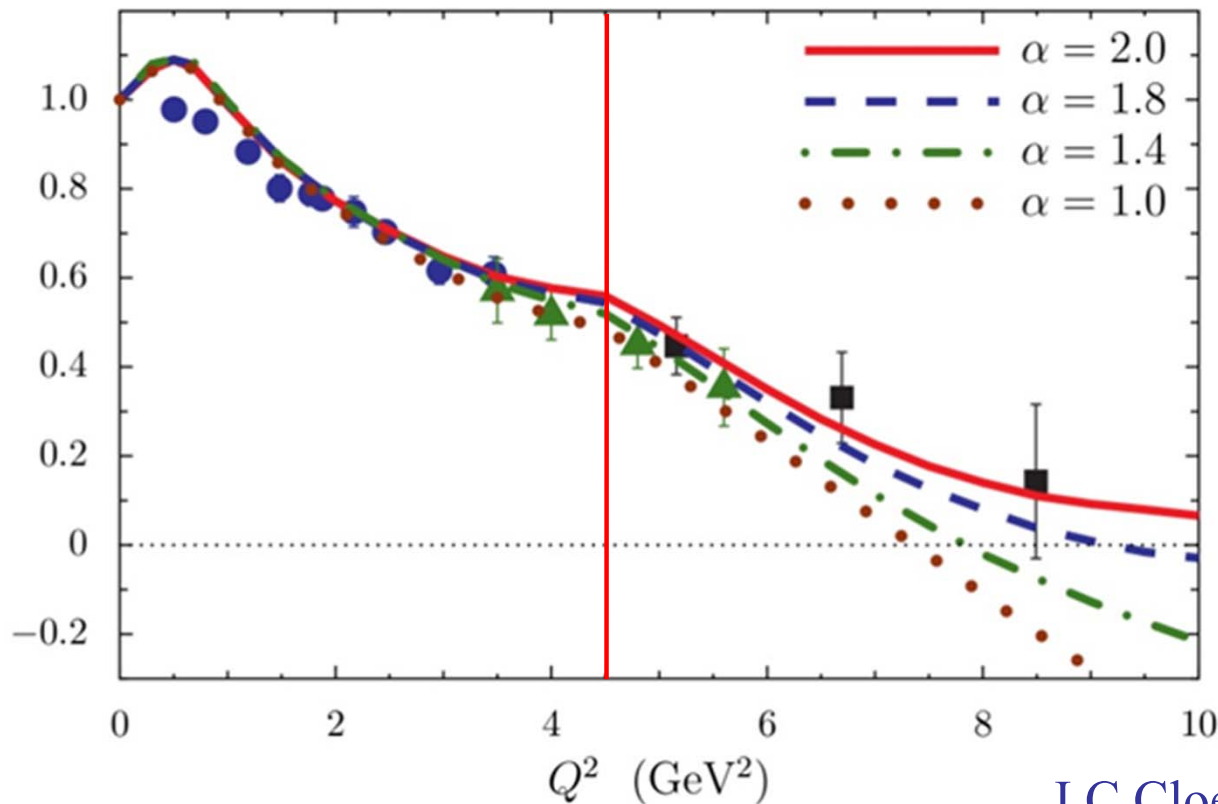

N^* electrocouplings can be determined by applying Bethe-Salpeter / Faddeev equations to 3 dressed quarks while the properties and interactions are derived from QCD.

The Faddeev-DSE calculation is very sensitive to the momentum dependence of the dressed-quark propagator.

I.C.Cloet et al., arXiv:1304.0855[nucl-th]

By the time of the upgrade DSE electrocouplings of several excited nucleon states will be available as part of the commitment of the Argonne NL and the University of Adelaide.

Int. J. Mod. Phys. E, Vol. 22, 1330015 (2013) 1-99

N \rightarrow Δ Multipole Ratios R_{EM} , R_{SM}

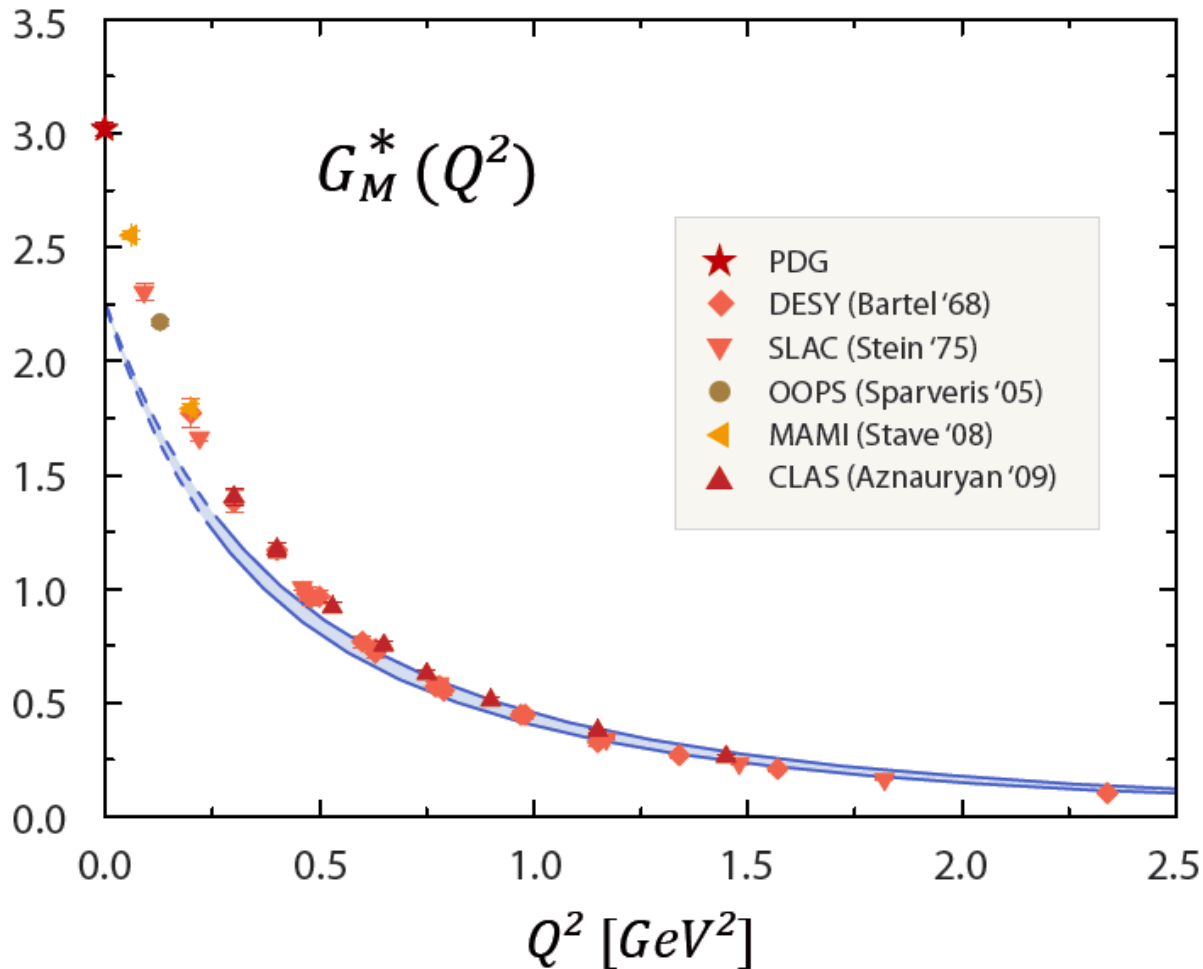

$$G_{M,Ash}^*(Q^2) = G_M^*(Q^2) / [1 + Q^2/t_+]^{1/2}$$

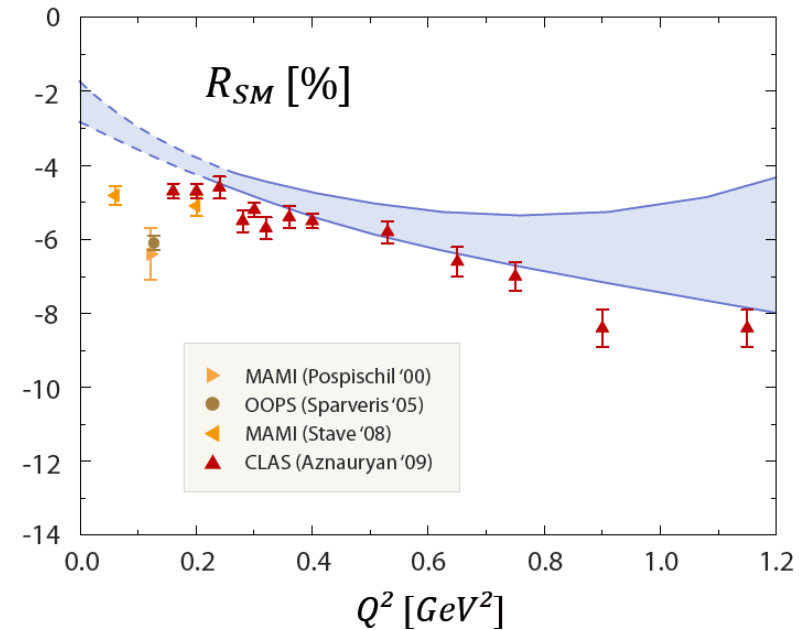
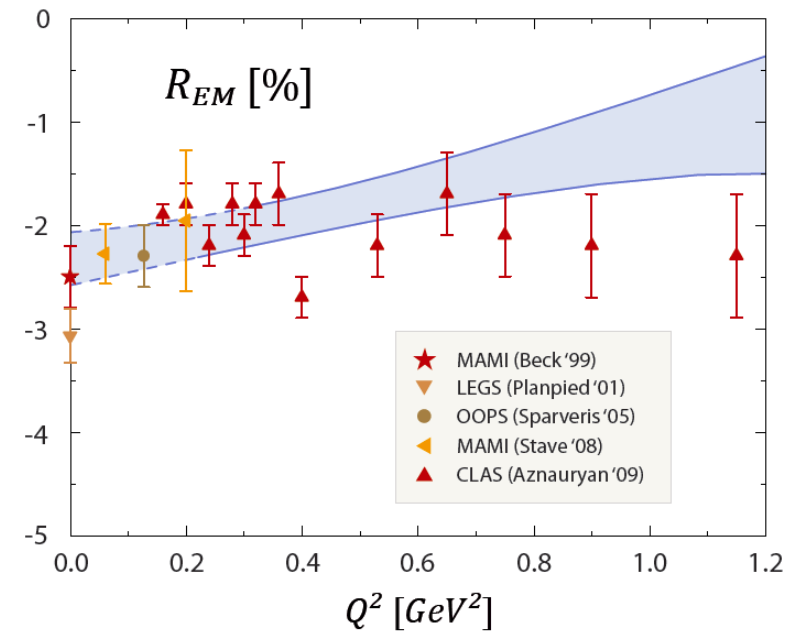

G. Eichmann et al., Phys. Rev. D85 (2012) 093004

DSE and EBAC Approaches

Location of the first 3-dressed-quark core radial excitation predicted by DSE

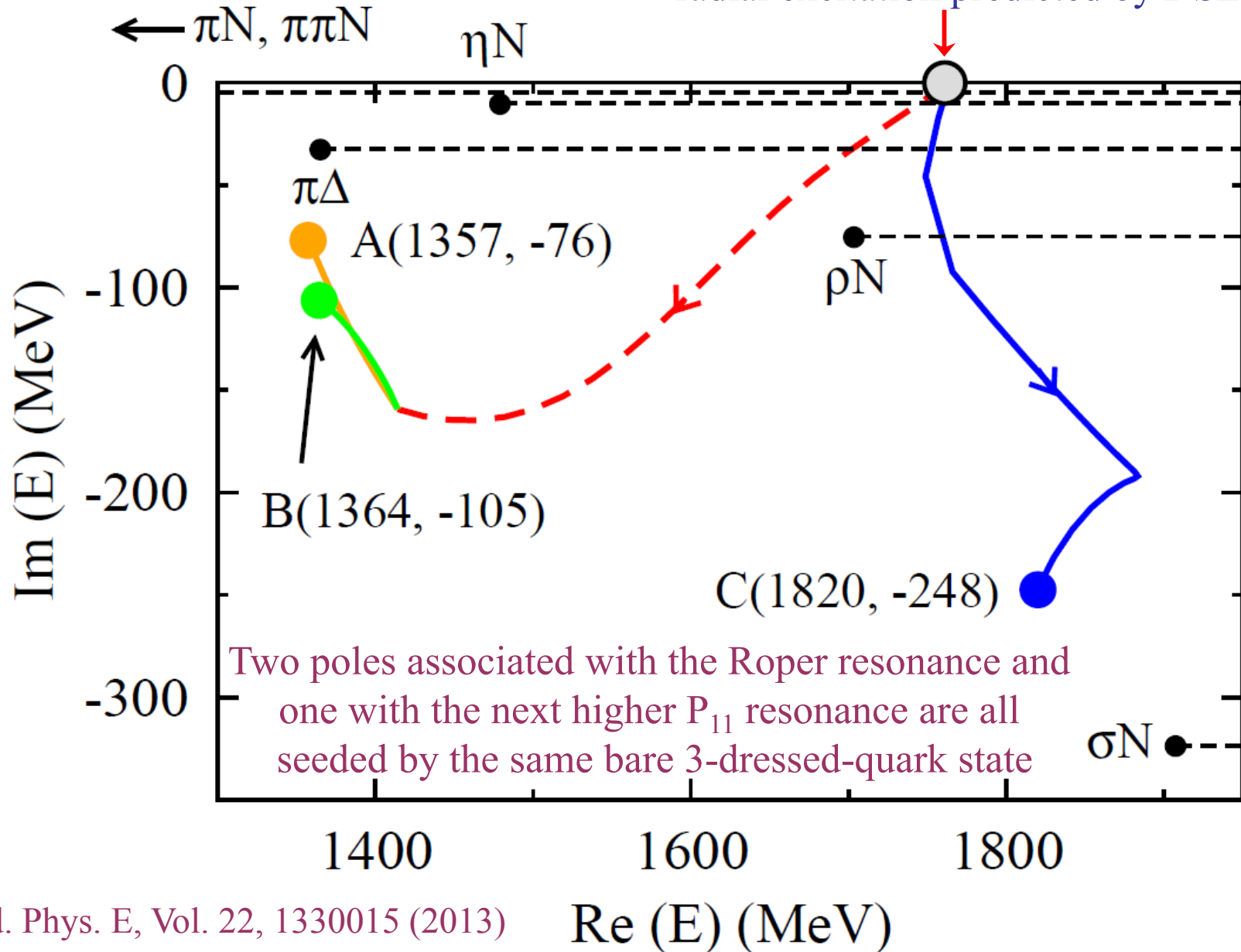

Roper Transition Form Factors in LQCD

$p(1440)P_{11}$

Huey-Wen Lin and S.D Cohen

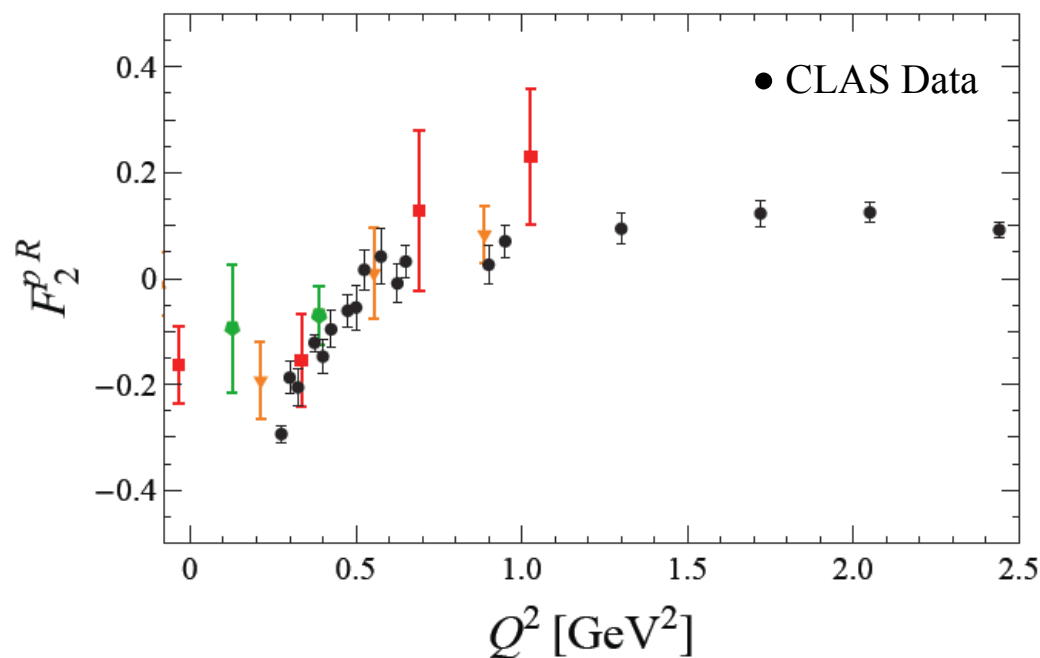
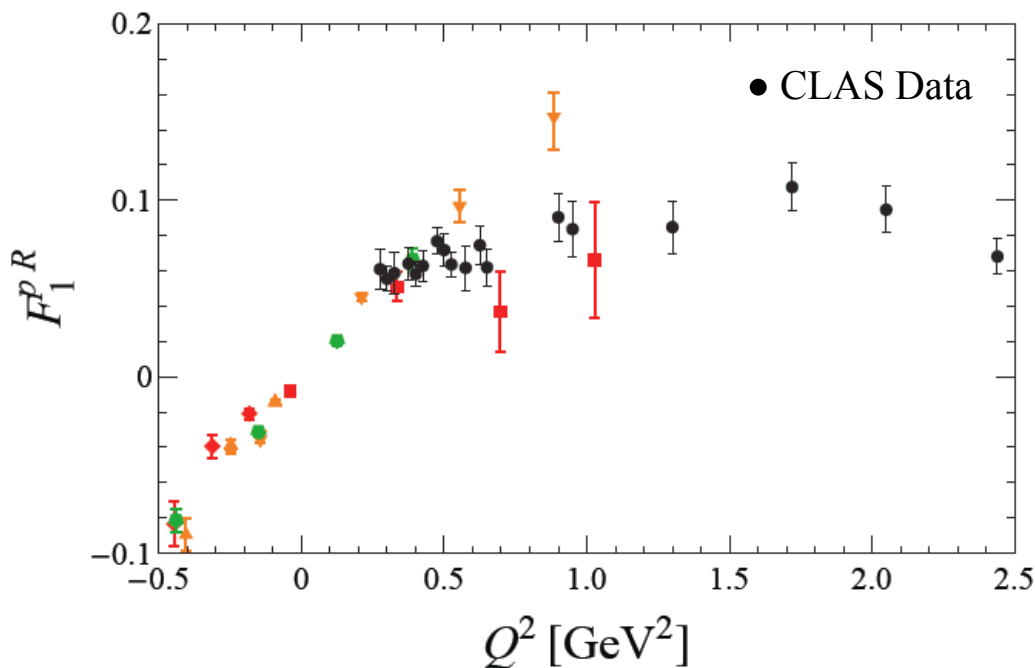

Lattice QCD calculations of the $p(1440)P_{11}$ transition form factors have been carried out with various pion masses, $m_\pi = 390, 450,$ and 875 MeV. Particularly remarkable is the zero crossing in F_2 that appears at the current statistics in the unquenched but not in the quenched calculations. This suggests that at low Q^2 the pion-cloud dynamics are significant in full QCD.

By the time of the upgrade LQCD calculations of N^* electrocouplings will be extended to $Q^2 = 10$ GeV² near the physical π -mass as part of the commitment of the JLab LQCD and EBAC groups in support of this proposal.

Int. J. Mod. Phys. E, Vol. 22, 1330015 (2013) 1-99

LQCD & Light Cone Sum Rule (LCSR) Approach

$N(1535)S_{11}$

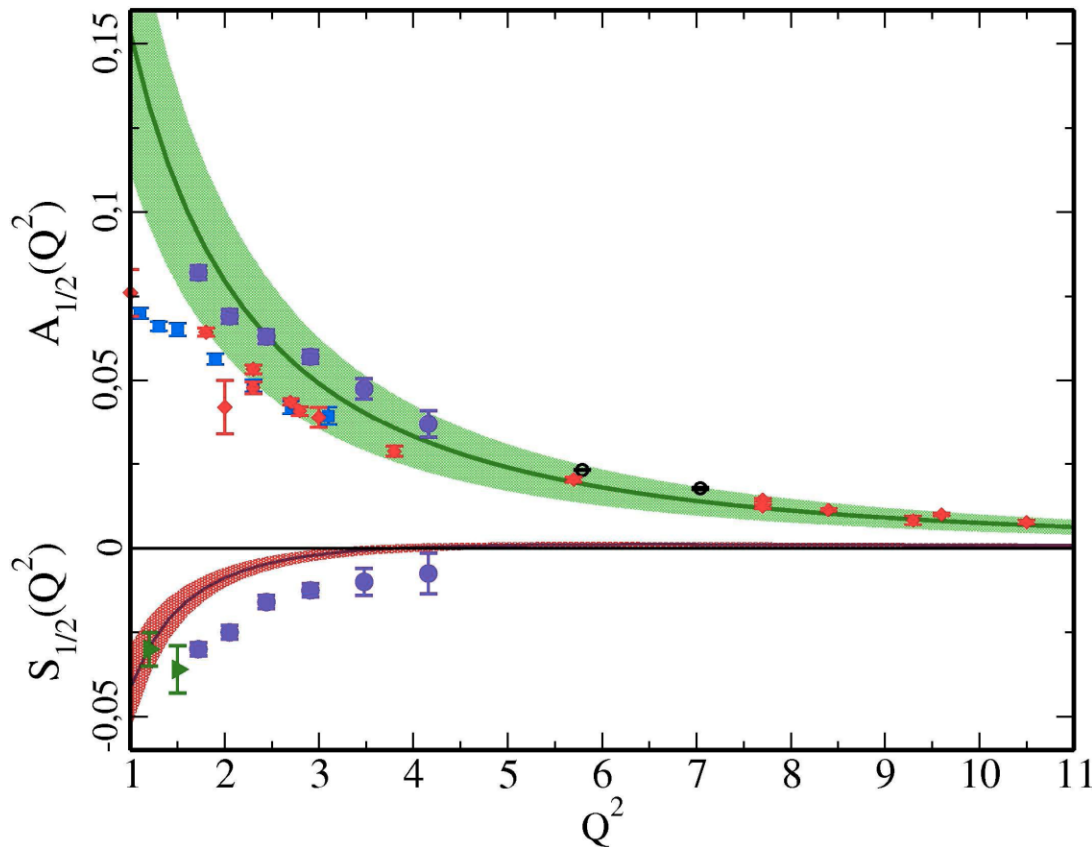

LQCD is used to determine the moments of N^* distribution amplitudes (DA) and the N^* electrocouplings are determined from the respective DAs within the LCSR framework.

Calculations of $N(1535)S_{11}$ electrocouplings at Q^2 up to 12 GeV^2 are already available and shown by shadowed bands on the plot.

By the time of the upgrade electrocouplings of others N^* s will be evaluated. These studies are part of the commitment of the Univ. of Regensburg group in support of this proposal.

Int. J. Mod. Phys. E, Vol. 22, 1330015 (2013) 1-99

E-09-003

... and more?

12 GeV CEBAF

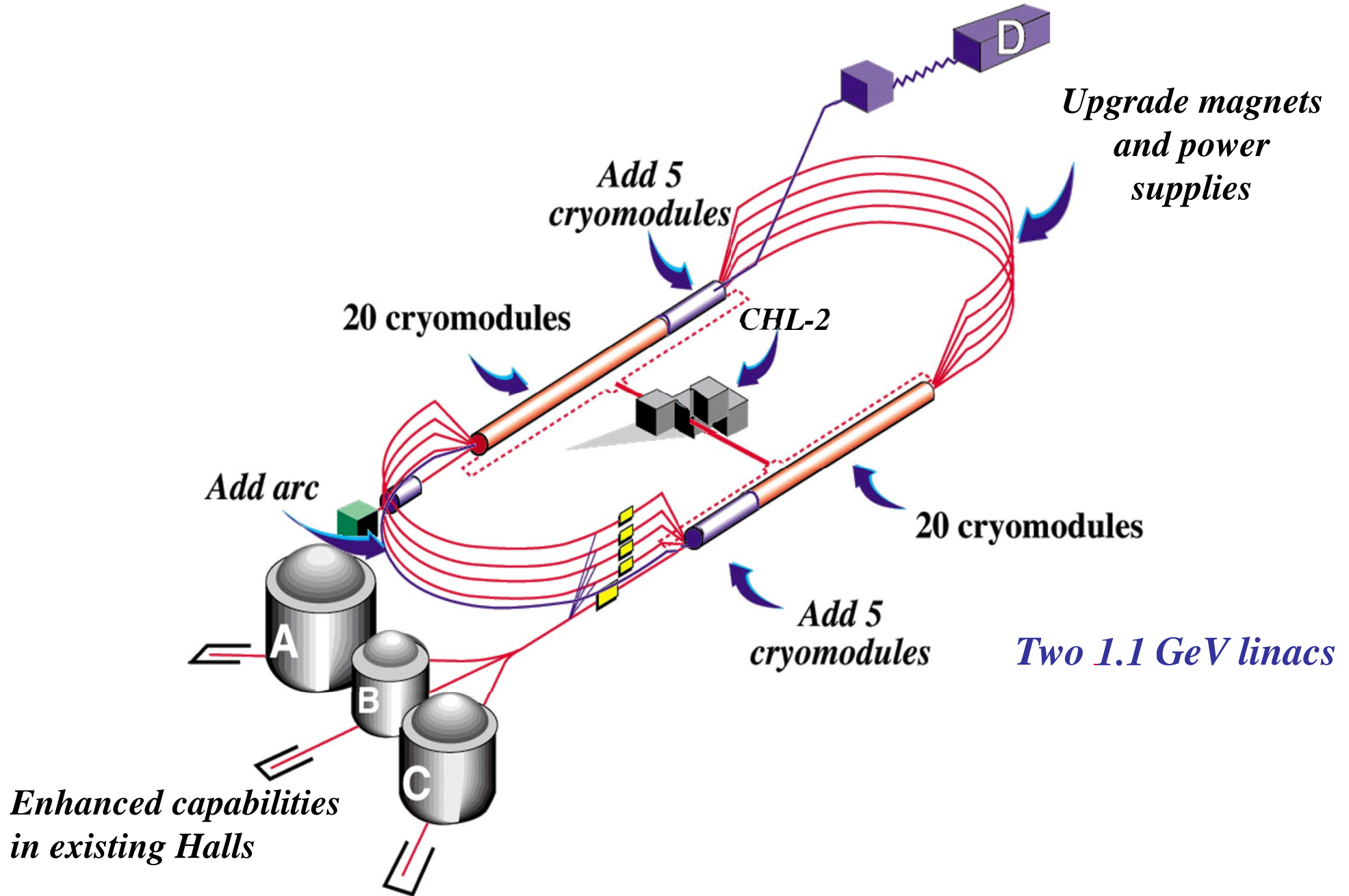

Overview of Upgrade Technical Performance Requirements

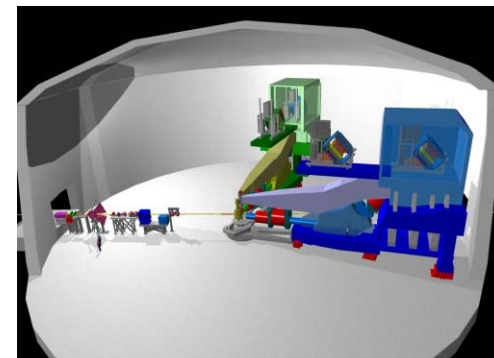
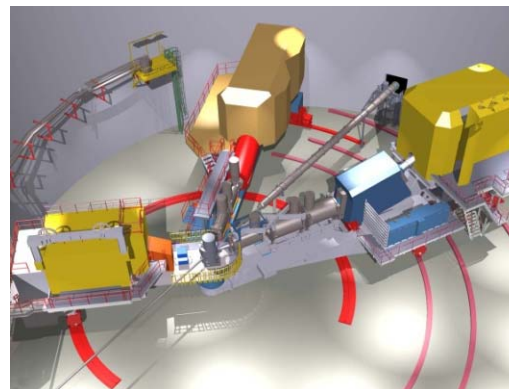
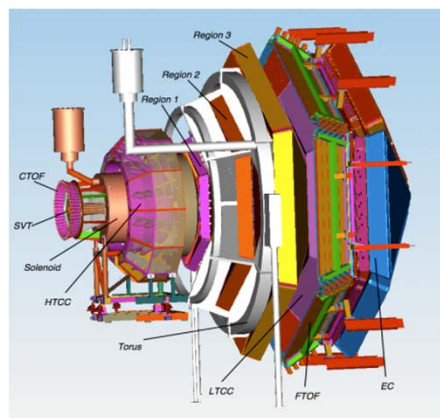
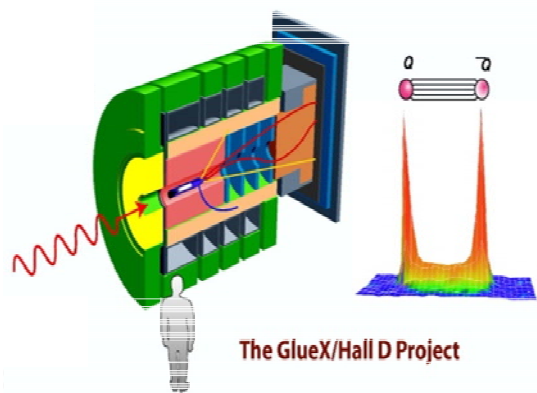

| Hall D | Hall B | Hall C | Hall A |
|-------------------------------------|--------------------------------|------------------------------------|-------------------------------------|
| 4 π hermetic detector GlueEx | luminosity 10^{35} CLAS12 | High Momentum Spectrometer SHRS | High Resolution Spectrometer HRS |
| polarized photons | hermeticity | precision | space |
| $E_\gamma \sim 8.5-9.0$ GeV | 11 GeV beamline | | |
| 10^8 photons/s | target flexibility | | |
| good momentum/angle resolution | excellent momentum resolution | | |
| high multiplicity reconstruction | luminosity up to 10^{38} | | |

Forward Photon Tagger for Spectroscopy

M. Battaglieri

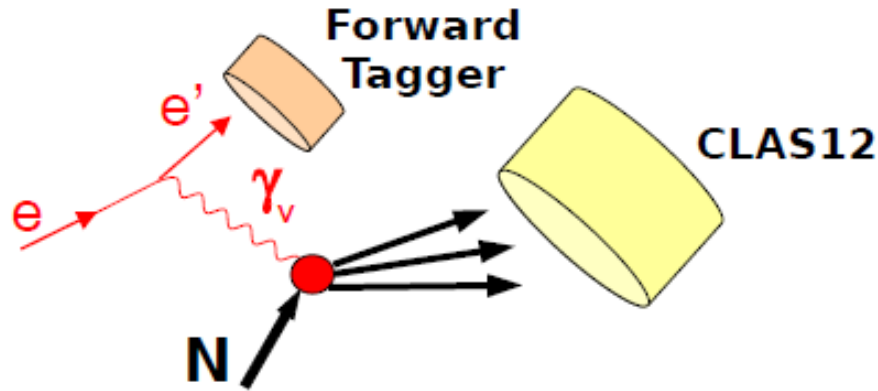

| | |
|-----------------|--|
| $E_{scattered}$ | 0.5 - 4.5 GeV |
| θ | $2.5^\circ - 4.5^\circ$ |
| ϕ | $0^\circ - 360^\circ$ |
| ν | 6.5 - 10.5 GeV |
| Q^2 | 0.01 - 0.3 GeV ² ($\langle Q^2 \rangle > 0.1$ GeV ²) |
| W | 3.6 - 4.5 GeV |

Calorimeter + hodoscope + tracker

Electron energy/momentum

Photon energy ($\nu = E - E'$)

Polarization $\epsilon^{-1} \sim 1 + \nu^2 / 2EE'$

Veto for photons

Electron angles

$Q^2 = 4 E E' \sin^2 \vartheta / 2$

Scattering plane

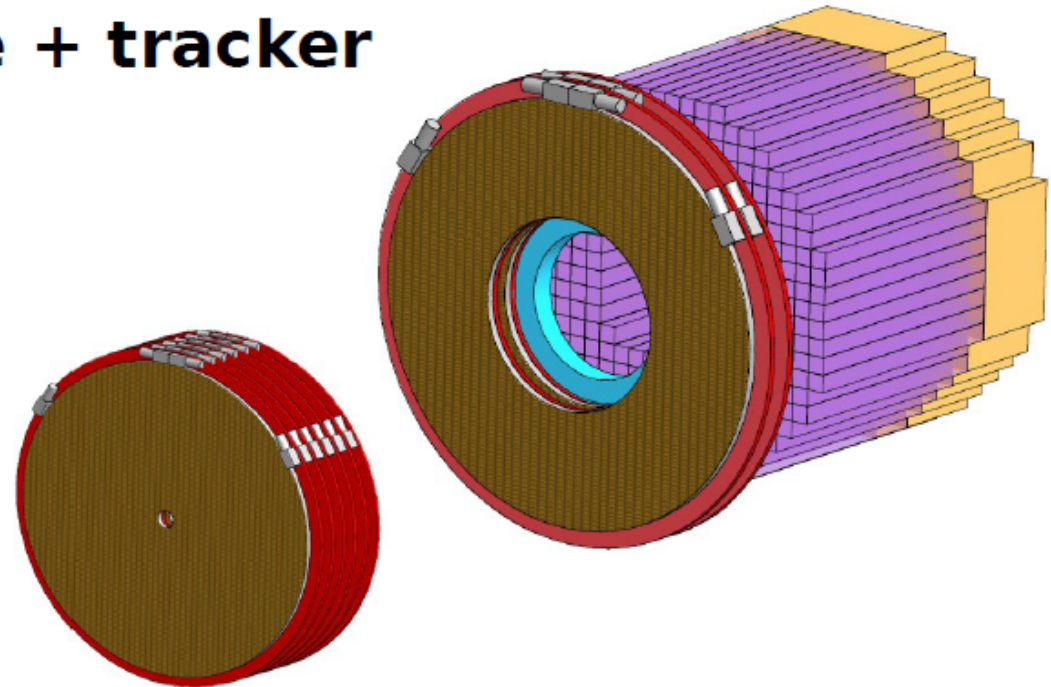

Rates in the forward tagger

$L_e \sim 10^{35} \text{ cm}^{-2} \text{ s}^{-1}$ ($N_\gamma \sim 5 \cdot 10^8 \text{ } \gamma/\text{s}$)

CLAS12

- Luminosity $> 10^{35} \text{ cm}^{-2}\text{s}^{-1}$
- Hermeticity
- Polarization

- Baryon Spectroscopy
- Elastic Form Factors
- N to N* Form Factors
- GPDs and TMDs
- DIS and SIDIS
- Nucleon Spin Structure
- Color Transparency
- ...

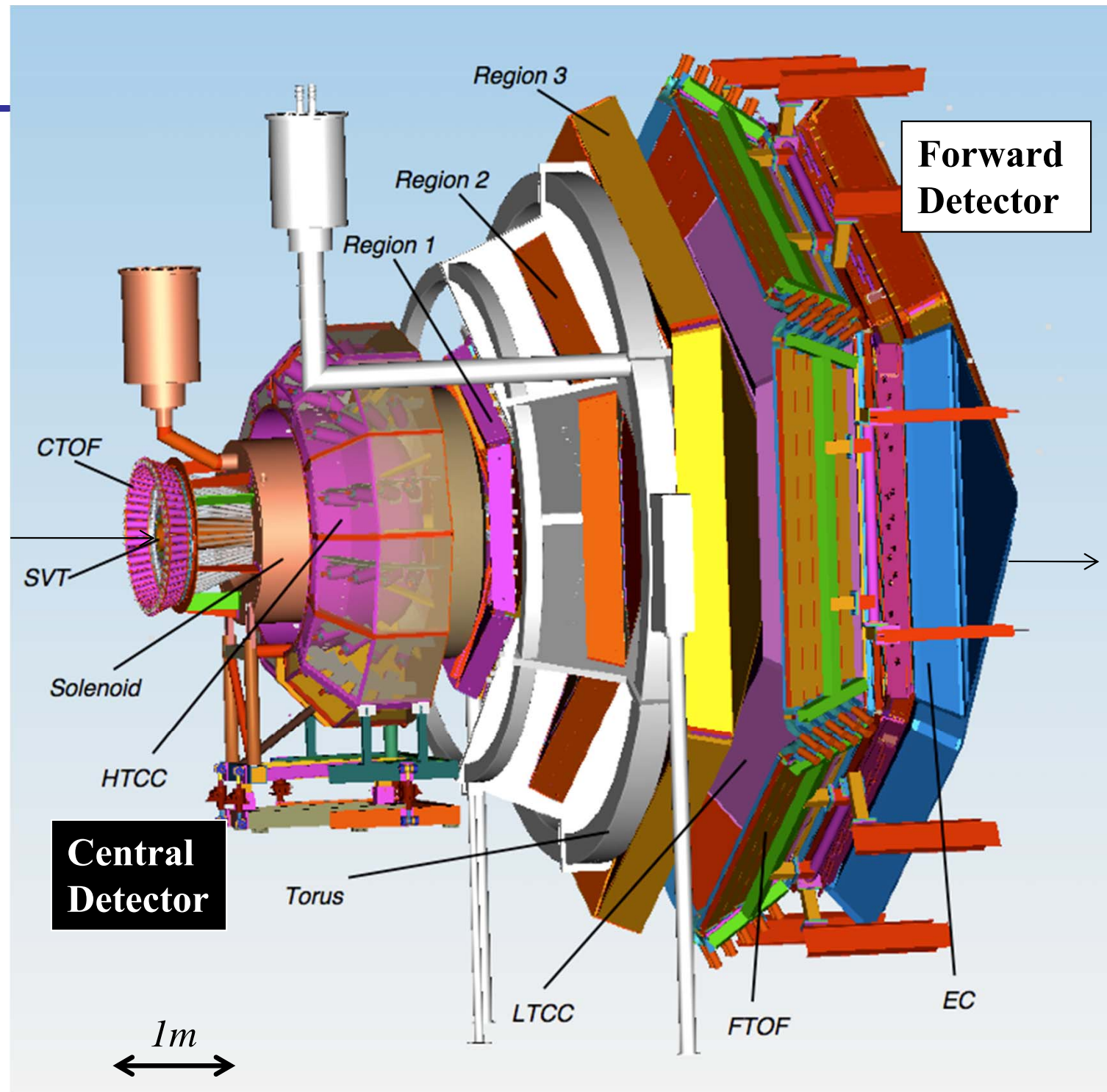

New Forward Time of Flight Detector for CLAS12

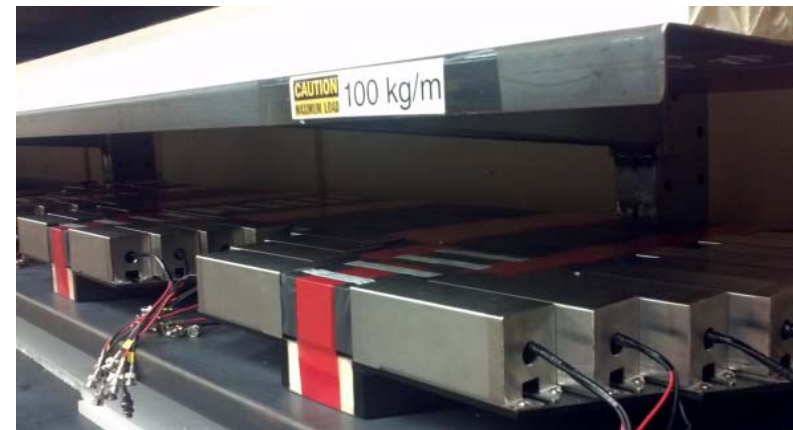
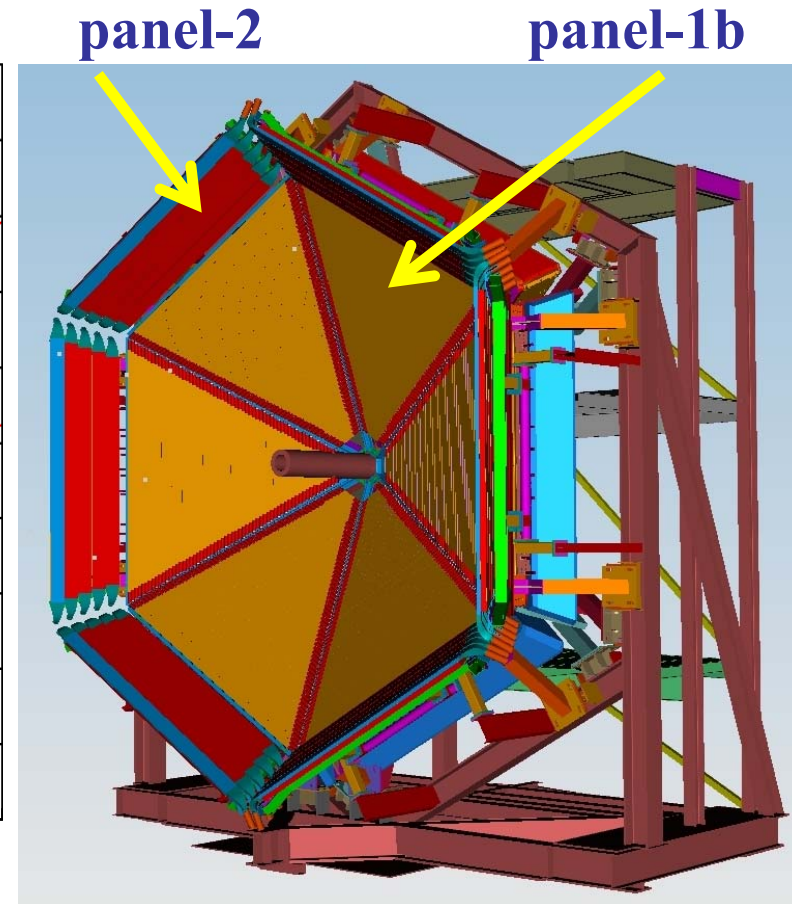
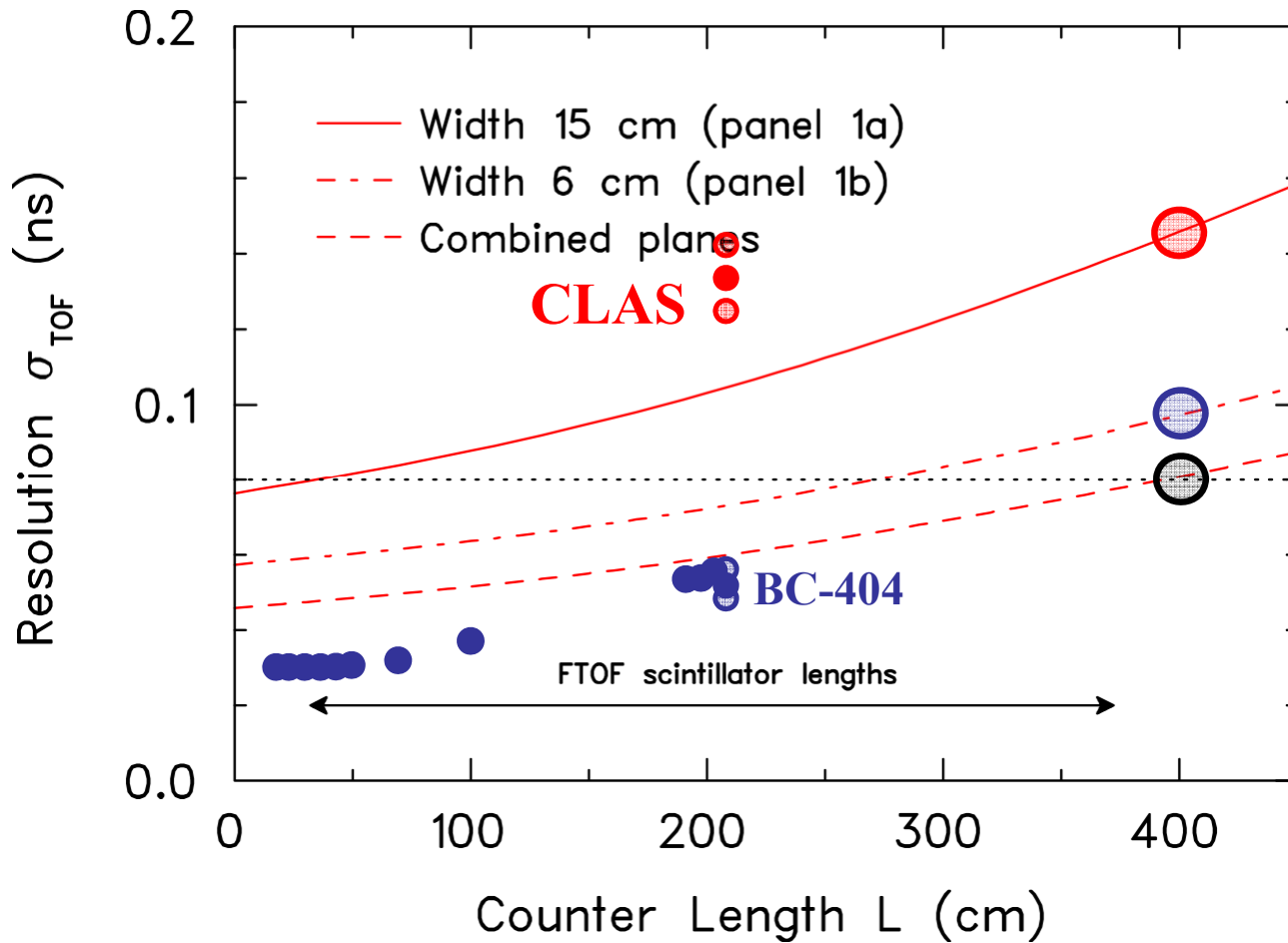

World-record time resolution of 48 ns
averaged over the full length of 210 cm



New Forward Time of Flight Detector for CLAS12

ToF12 Time Resolution Measurements

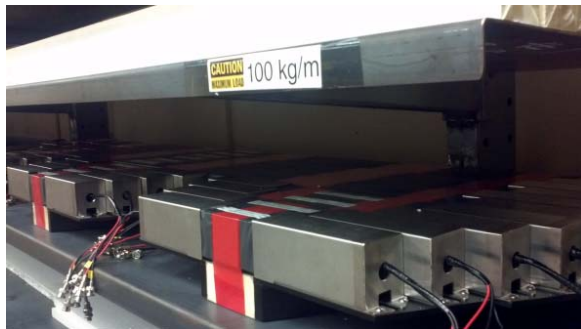
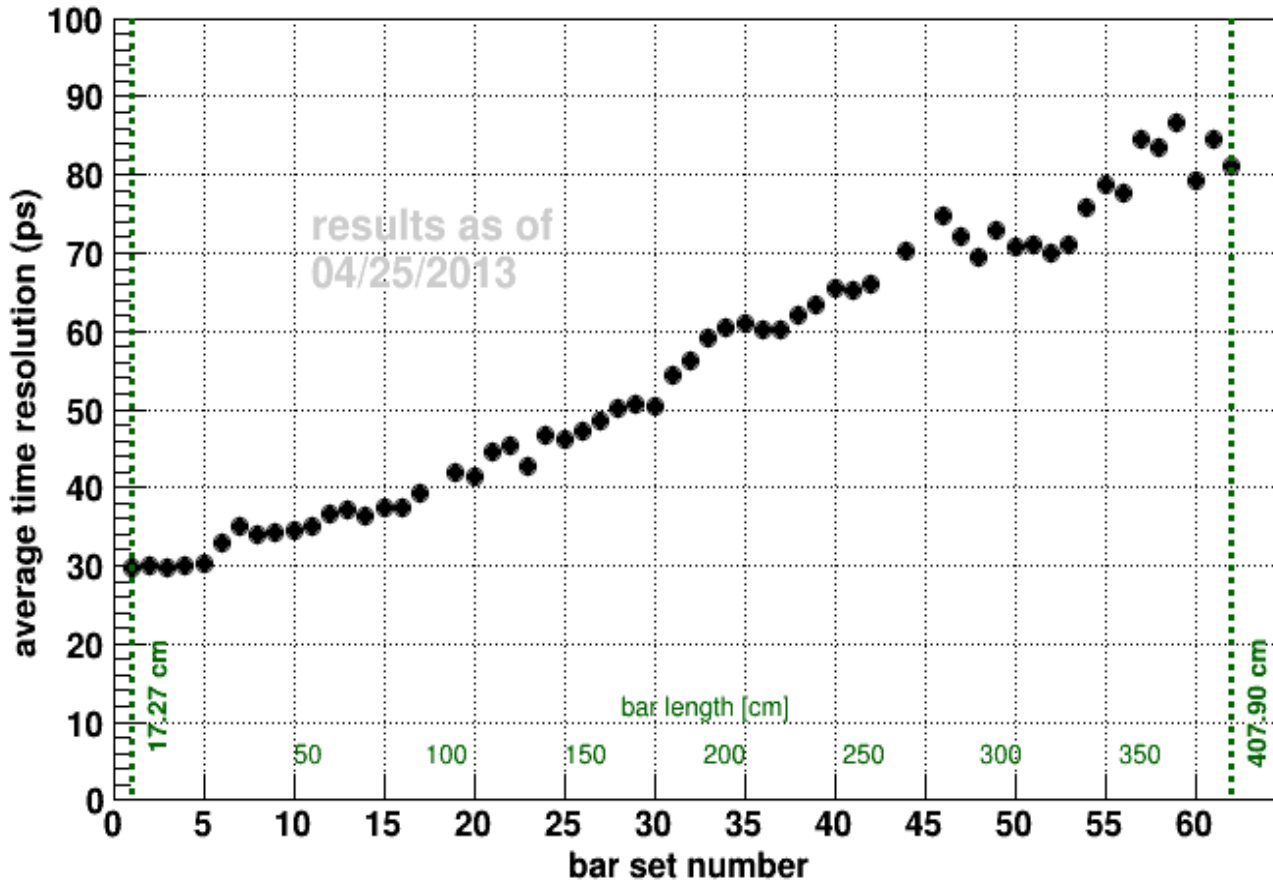

CLAS 12 Kinematic Coverage and Counting Rates

Genova-EG

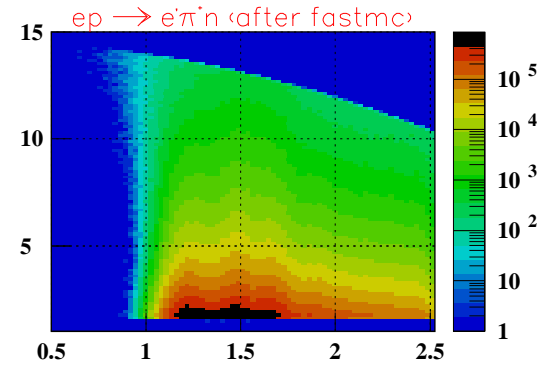
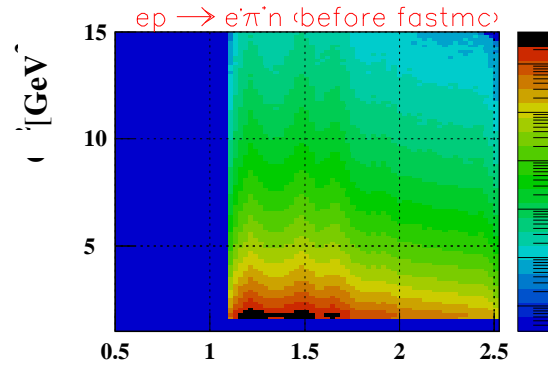

(e', π^+) detected

Genova-EG

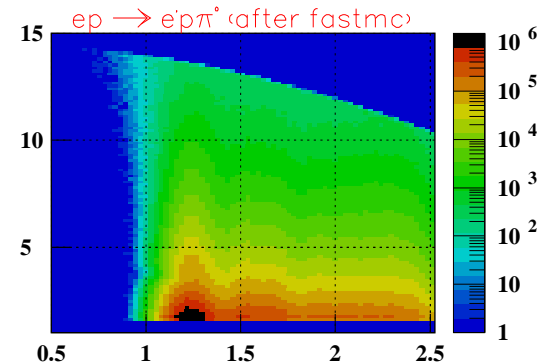
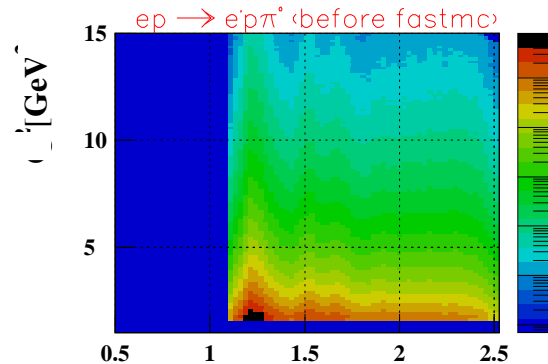

(e', p) detected

| (E, Q^2) | $(5.75 \text{ GeV}, 3 \text{ GeV}^2)$ | $(11 \text{ GeV}, 3 \text{ GeV}^2)$ | $(11 \text{ GeV}, 12 \text{ GeV}^2)$ |
|--------------|---------------------------------------|-------------------------------------|--------------------------------------|
| $N^{n\pi^+}$ | $1.41 \cdot 10^5$ | $6.26 \cdot 10^6$ | $5.18 \cdot 10^4$ |
| $N^{p\pi^0}$ | - | $4.65 \cdot 10^5$ | $1.45 \cdot 10^4$ |
| $N^{p\eta}$ | - | $1.72 \cdot 10^4$ | $1.77 \cdot 10^4$ |

$$L=10^{35} \text{ cm}^{-2} \text{ sec}^{-1}, W=1535 \text{ GeV}, \Delta W=0.100 \text{ GeV}, \Delta Q^2=0.5 \text{ GeV}^2$$

40 days

PAC35

Anticipated N^* Electrocouplings from a Combined Analysis of $N\pi$ & $N\pi\pi$

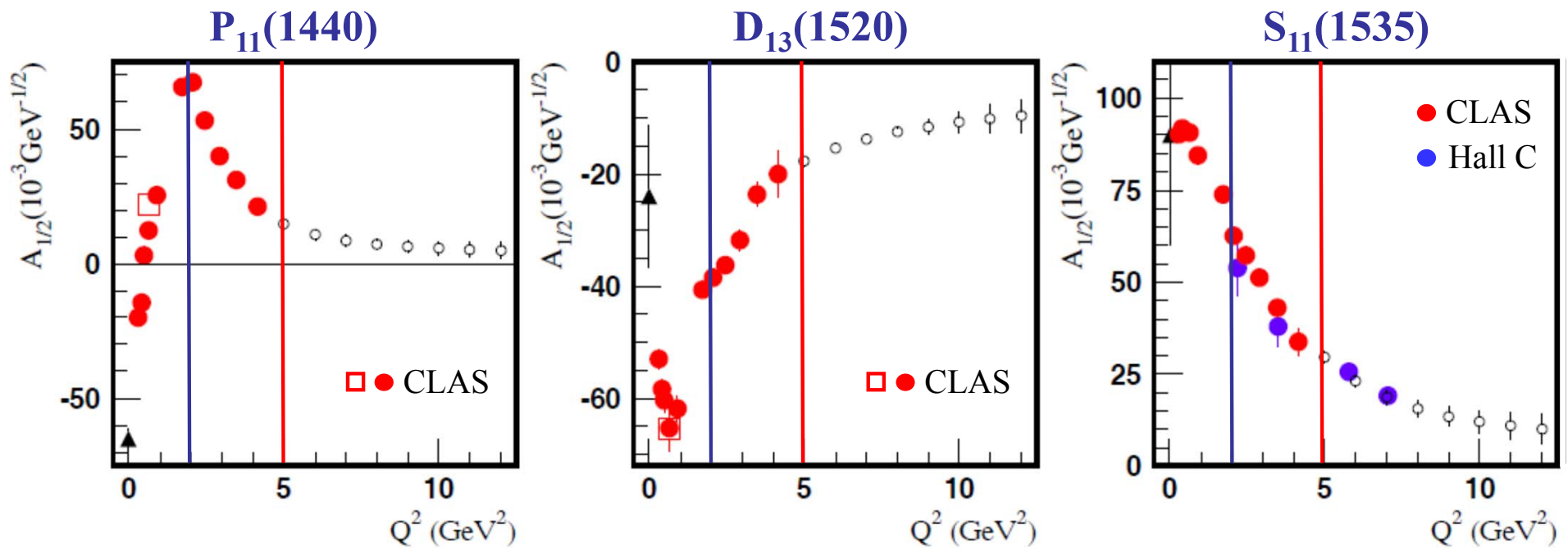

Open circles represent projections and all other markers the available results with the 6-GeV electron beam

- Examples of **published and projected results** obtained within **60d** for three prominent excited proton states from analyses of $N\pi$ and $N\pi\pi$ electroproduction channels. Similar results are expected for many other resonances at higher masses, e.g. $S_{11}(1650)$, $F_{15}(1685)$, $D_{33}(1700)$, $P_{13}(1720)$, ...
- This experiment will – for the foreseeable future – be **the only experiment** that can provide data on $\gamma_v NN^*$ electrocouplings for almost all well established excited proton states at the highest photon virtualities ever achieved in N^* studies up to Q^2 of 12 GeV^2 .

Summary

- We will measure and determine the electrocouplings $A_{1/2}$, $A_{3/2}$, $S_{1/2}$ as a function of Q^2 for prominent nucleon and Δ states,
 - see our Proposal <http://www.physics.sc.edu/~gothe/research/pub/nstar12-12-08.pdf>.
- Comparing our results with DSE, LQCD, LCSR, and rCQM will gain insight into
 - the strong interaction of dressed quarks and their confinement in baryons,
 - the dependence of the light quark mass on momentum transfer, thereby shedding light on dynamical chiral-symmetry breaking, and
 - the emergence of bare quark dressing and dressed quark interactions from QCD.
- This unique opportunity to understand origin of 98% of nucleon mass is also an experimental and theoretical challenge. A wide international collaboration is needed for:
 - the development of reaction models that will account for hard quark/parton contributions at high Q^2 and
 - the theoretical interpretation on N^* electrocouplings, see our Review Article Int. J. Mod. Phys. E, Vol. 22, 1330015 (2013) 1-99.
- Any constructive criticism, help, or participation is always most welcomed, contact:
 - Viktor Mokeev mokeev@jlab.org or Ralf Gothe gothe@sc.edu.